

Mobio

MONITOR ARM

Experience unmatched performance.

When you're hard at work, you need a workspace that works hard for you. With a wide range of motion and ultra-reliability, Mobio is your go-to solution for a family of monitor arms to maximize your space. Its compact design and die cast aluminum construction mean greater stability, flexibility and unmatched performance.



Dual Desk Monitor Arm
Table not included. See [page 417](#) for Switchback.

EFFECTIVE OCTOBER 17, 2022

Featured Models

POWER READY :: \$477

Mobio single desk monitor arm with power block accessory

DUAL DESK :: \$605

Mobio dual desk monitor arm

DUAL ARRAY HD :: \$702





Mobio heavy duty dual array monitor arm

Features

- Choose from Mobio arms in single-desk, dual-desk and pole-mount configurations
- Choose from Mobio HD arms in single-desk, dual-desk and dual-array configurations
- Compact aluminum arm design maximizes desktop space
- Die-cast aluminum construction ensures stability and performance
- Gas spring mechanism delivers smooth vertical adjustment
- Built-in spring tension gauge enables perfect weight adjustment
- Provide power to any worksurface with optional add-on power modules or passthrough USB cables
- Tool-less monitor sliders attach quickly and give an extra dimension of adjustability
- Includes surface clamp and grommet mount, ideal for all desk mounting configurations
- Power-ready and HD dual array models feature 180-degree rotation lock to keep all arms (and elbows) from bumping into walls
- Install monitors easily with quick-release VESA plate
- Mobio arms support monitors 17" to 32" (3.3 lb–17.6 lb); Mobio HD arms support monitors 17"–35" inches (2.2 lb–33 lb)

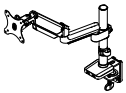
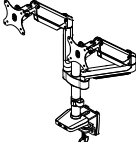
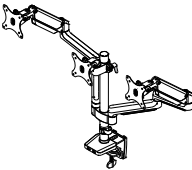
MONITOR ARM

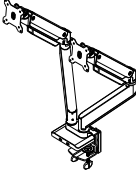
1. Product

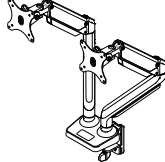
Product Style	Code	Price	
Mobio			
Single Pole Monitor Arm	3210 MAT30	\$387	
Dual Pole Monitor Arm	3210 MAT31	\$696	
Triple Pole Monitor Arm	3210 MAT32	\$807	
Single Desk Monitor Arm	3210 MAT33	\$303	
Dual Desk Monitor Arm	3210 MAT34	\$605	
Single Desk Monitor Arm, Power Ready	3210 MAT38	\$303	
Dual Desk Monitor Arm, Power Ready	3210 MAT39	\$605	

MONITOR ARM

1. Product (Cont.)

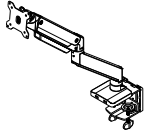
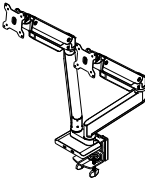
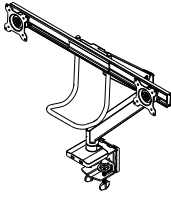
Product Style	Code	Price	
Mobio HD			
Heavy Duty Single Desk Monitor Arm	3210 MAT35	\$473	
Heavy Duty Dual Desk Monitor Arm	3210 MAT36	\$1,060	
Heavy Duty Dual Array Monitor Arm	3210 MAT37	\$702	

2. Accessories

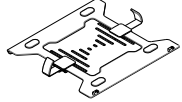
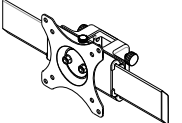
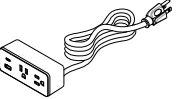
Laptop Support	Code	Price	
No Accessories	MAA00	+ \$0	
Laptop Tray	MAA03	+ \$99	
Monitor Sliders	Code	Price	
Single Slider	MAA01	+ \$120	
Dual Sliders	MAA02	+ \$239	
Power	Code	Price	
Power Block, AC/110V, USB-A, USB-C	MAA03	+ \$174	

Power block (MAA03) is available on independently (MAT00) or on power ready models (MAT38/MAT39) only.

3. Monitor Arm Finish

Paint Color	Code	Price	
Silver	MAC01	+ \$0	
Black	MAC03	+ \$0	

HD models are available in silver (MAC01) finish only.



Power Ready
Table not included. See [page 438](#) for Switchback.

SPECIFICATIONS: POLE ARMS

	MAT30 Single Pole	MAT31 Dual Pole	MAT32 Triple Pole
Max Monitor Size	17"-32"	17"-32"	17"-27"
Max Arm Extension (A)	23.16"	21.3"	28.58"
1st Arm Segment (B)	3.21"	3.21"	3.21"
2nd Arm Segment (C)	10.83"	10.83"	10.83"
3rd Arm Segment (D)	9.12"	7.27"	7.27"
Height Range (E)	3.54"-22.65"	3.54"-22.64"	6.10"-17.13"
Pole Height (F)	12.58"	12.58"	18.09"
Table Top Thickness	0.39"-2.17"	0.39"-2.17"	0.39"-2.17"
VESA	75 mm 100 mm	75 mm 100 mm	75 mm 100 mm
Weight Capacity (Per Screen)	3.3-17.6 lb	3.3-17.6 lb	3.3-17.6 lb

SPECIFICATIONS: DESK ARMS

	MAT33 Single Desk	MAT34 Dual Desk
Max Monitor Size	17"-32"	17"-32"
Max Arm Extension	20.72"	20.72"
1st Arm Segment (B)	3.21"	3.21"
2nd Arm Segment (C)	10.83"	10.83"
3rd Arm Segment (D)	6.68"	6.68"
Height Range (E)	5.31"-16.24"	5.31"-16.24"
Table Top Thickness	0.39"-2.17"	0.39"-2.17"
VESA	75 mm 100 mm	75 mm 100 mm
Weight Capacity (Per Screen)	3.3-17.6 lb	3.3-17.6 lb

SPECIFICATIONS: HEAVY DUTY ARMS

	MAT35 Single Desk HD	MAT36 Dual Desk	MAT37 Dual Array
Max Monitor Size	17"-35"	17"-35"	17"-32"
Max Extension (A)	23.49"	23.49"	12.68"
1st Arm Segment (B)	2.73"	2.73"	4.09"
2nd Arm Segment (C)	12.62"	12.62"	12.68"
3rd Arm Segment (D)	8.14"	8.14"	8.14"
Height Range	10.03"-23.03"	10.03"-23.03"	10.43"-23.43"
Table Top Thickness	0.39"-2.04"	0.39"-2.04"	0.39"-2.04"
VESA	75 mm 100 mm	75 mm 100 mm	75 mm 100 mm
Weight Capacity (Per Screen)	2.2-33 lb	2.2-33 lb	2.2 lb-17.6 lb

MONITOR ARM

FULLY EXTENDED POLE MODELS

(MAT30 | MAT31 | MAT32)

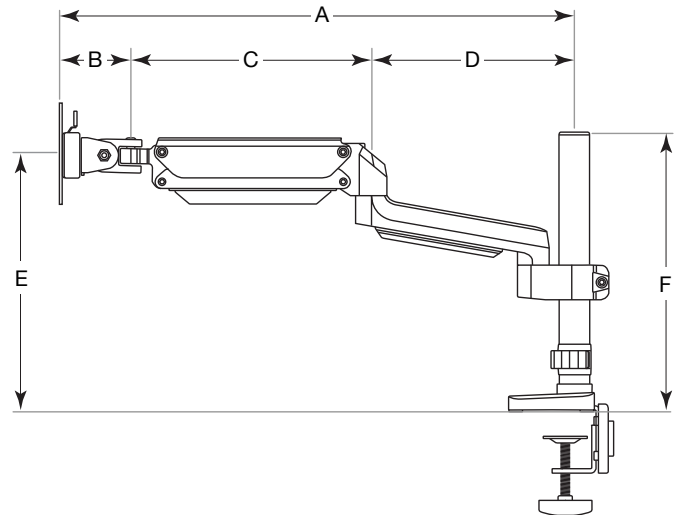

FULLY EXTENDED DESK AND HEAVY DUTY MODELS

(MAT33 | MAT34 | MAT35 | MAT36 | MAT37)

