

SitOnIt • Seating®

Multipurpose and Side Price List February 23, 2026



TABLE OF CONTENTS

Intro

Sustainable Design.....	4
Warranty	5
Ordering Information	8
CAL 133.....	12
COM/COL and Textile Testing Process	14
Textile Test Request Form	15

Upholstery Information.....	16
Upholstery Direction Form	17
COM Calculation	18
COM/COL Yardage: Multipurpose and Side	19
Custom Finish Program.....	23

Multipurpose, Side and Guest Chairs ; Counter and Bar Stools

Achieve

Multipurpose Chair.....	28
-------------------------	----

Anytime

Multipurpose Chair and Bar Stool.....	31
---------------------------------------	----

Axys

Guest, Lounge, Bar and Counter Stool.....	35
---	----

Baja

Multipurpose Chair and Bar Stool.....	38
---------------------------------------	----

Clova

Guest Chair	43
Side Chair.....	46

Cora

Multipurpose Chair, Bariatric, Counter Stool and Bar Stool	49
Replacement Seating Parts.....	54

Flytech

Stacking Nester Chair	55
-----------------------------	----

Focus Side

Multipurpose Chair, Counter Stool and Bar Stool.....	59
--	----

Freelance

Multipurpose Chair, Counter Stool and Bar Stool.....	64
Bariatric Chair.....	70

InFlex

Multipurpose Chair, Counter Stool and Bar Stool.....	73
--	----

Ioniq

Side Chair.....	77
-----------------	----

Lumin

Multipurpose Chair, Counter Stool and Bar Stool.....	79
--	----

Mika

Multipurpose Chair, Counter Stool and Bar Stool.....	84
--	----

Movi

Nester Chair	88
--------------------	----

Orbix

Multipurpose Chair and Bar Stool.....	92
---------------------------------------	----

Qwiz

Nester Chair	96
--------------------	----

Relay

Nester Chair	100
--------------------	-----

Rio

Multipurpose Chair, Counter Stool and Bar Stool.....	103
--	-----

Rowdy

Multipurpose Chair.....	107
-------------------------	-----

Sprout

Multipurpose Chair.....	110
-------------------------	-----

Wit Side

Mesh Back Multipurpose Chair.....	113
Thintex Back Multipurpose Chair.....	116

Appendix

Super Duty Series Guide.....	121
Care and Cleaning.....	124
Glide Guide.....	126
Stacking Guide.....	127
Plastics Color Program.....	129
Mesh Color Program	130
Multipurpose Chair Options	132

SitOnIt • Seating®

CALIFORNIA BORN AND BRED

We're a leading manufacturer of commercial, healthcare, and education solutions in North America. From tables and lounge to screens and more, we've been the go-to destination for comprehensive, build-to-order solutions for over 25 years. We combine award-winning design with the fastest lead times around, and our design and planning services can turn product innovation into your space inspiration. We're able to build almost any specification you want, deliver it when you need it, and offer a level of value no one can match. It's all part of our indie California spirit and drive to be the one place you go for all of your spaces.

DESIGN THAT GETS YOU

Discover seating engineered around you. Experience responsive design, supreme comfort and hyper-customizable features—all at value-driven prices.

OUR BUILD-TO-ORDER PROMISE

Custom-designed chairs, no waiting. Our nimble size and lean manufacturing operation means we can ship build-to-order chairs in just two days.

FASTEST SHIPPING IN THE INDUSTRY

We cut lead time, sync orders and avoid off-schedule shipments at a rate our competitors just can't match. Our entire offering is shipped quick – within 5 to 10 days, for fast delivery.

WORLD-CLASS SERVICE

We're proud to announce that the Office Furniture Dealer Alliance voted for us as "Best Customer Service" three times in the past five years.

SUSTAINABLE DESIGN

We make it easy to go green. Design an eco-friendly room from the ground up or upgrade an existing space to meet the latest environmental standards.



LEED Certified

Earn points toward LEED certification thanks to our U.S. manufacturing location and our use of recycled materials where possible.



GREENGUARD Certification

All SitOnIt Seating lounge and seating products met the rigorous criteria required by GREENGUARD in accordance with the Collaborative for High Performance Schools.



LEVEL Certified

Sustainability matters. That's why we've worked to achieve BIFMA LEVEL® certification for all task chairs, side chairs and lounge products.



PFAS

As a California-based furniture manufacturer, we're committed to sustainability, safety, and full compliance with California AB 1817—ensuring that all carded and graded-in fabrics used in our products are free from intentionally added PFAS (Per- and Polyfluoroalkyl Substances). We work closely with our textile partners to uphold rigorous environmental and consumer safety standards.



The Take Back Program

SitOnIt Seating helps minimize product waste by connecting our customers and dealers with third-party groups who redirect materials that would be headed for the landfill to local nonprofits and public agencies.



We Did Our Homework

Download detailed documents that break down the percentage of recycled content, manufacturing processes and indoor air emissions for every chair we make.

WARRANTY

Product Warranty Periods

Exemplis LLC, d.b.a. SitOnIt Seating (hereafter referred to as the Company), warrants to the original end user that this product will be free from defects in its material and workmanship when used in a single shift (standard eight-hour day, five days per week) for the following warranty periods:

LIFETIME WARRANTY COVERAGE:

- All SitOnIt Seating products, except where noted below
- Structural Components: eBEAM, HiQ, Parallon, Prise, Surge, Switchback and Voyager
- Structural: Kindl frame.

12-YEAR WARRANTY COVERAGE:

- Amplify, Cora (Guest, Hip and Stool), Focus 2.0, Kindl (bariatric, guest, freespan and preconfigured), Novo, Torsa, and Wit used in multi-shift (24/7) applications.
- Lounge seating and occasional/lounge tables
- Bases: Ocala, Tensor
- Laminate tops
- Monitor arms¹: Mobio series, Unity G2
- Plastic shells

10-YEAR WARRANTY COVERAGE:

- Non-Stop Heavy Duty, Cora (Midsize and Bariatric), Freelance Bariatric and chairs purchased with a Heavy Duty (HD) or Large and Tall (LT) option used in multi-shift (24/7) applications
- Electrical Components: eBEAM, HiQ, Parallon, Prise, Surge and Switchback

FIVE-YEAR WARRANTY COVERAGE:

- Fabric, foam, knit back, and mesh
- All filing products³
- CPU holders
- Screens⁴
- High Tide
- Keyboard trays
- Lighting fixtures
- Power components⁵: EON, Current, Power Strips
- Wire management

TWO-YEAR WARRANTY COVERAGE:

- Fabric and foam cushioning for Non-Stop Heavy Duty, Freelance Heavy Duty, Cora Midsize and Bariatric, Kindl bariatric and chairs purchased with an HD or LT option
- Multipurpose felt glides
- Half-Moon Pencil Drawer

ONE-YEAR WARRANTY COVERAGE:

- Lighting power supplies
- Mouse pads
- Wrist rests

1. Weight capacity of the monitor arms must be followed. If an arm is not functioning properly because of the weight of the monitor is outside of the advertised weight capacity, the monitor arm will not be considered defective under the warranty.

2. Please note that electrical components on a height-adjustable table include: hand controls, motors, control boxes and electrical cables.

3. This warranty does not cover damage from ordinary wear and tear, including paint finish changes and/or discoloration resulting from aging or exposure to light.

4. Warranty limited to finishes, tacking surface of tack boards and writing surface of whiteboards. Standard textiles limited to original manufacturer's warranty.

5. Power components are defined as any power unit with electrical outlets and/or USB/data connections, connector jumper cables for daisy chain and infeeds for hardwire applications.

WARRANTY

Freight Warranty

At SitOnIt Seating™, we take pride in crafting one-of-a-kind pieces. Products are thoughtfully inspected prior to being carefully wrapped and packed for shipment. Upon receiving your order, should your order be less than perfect, please follow these steps for an expedited resolution:

IF DAMAGE IS VISIBLE:

- Please accept shipment and report damages on the freight bill.
- Contact SitOnIt Seating Customer Experience to report the issue **within 10 days** after delivery.

IF DAMAGE IS CONCEALED:

- Save merchandise and packaging.
- Take a photo to document the damage.
- Contact SitOnIt Seating Customer Experience to report the issue **within 60 days** after delivery.

Either way, we are here to help! SitOnIt Seating Customer Experience Team is on standby to assist Monday through Friday, 5:00 a.m. to 5:00 p.m. PST. Call (888) 274-8664 or email sitonit@exemplis.com.

The Company Does Not Warranty

- COM/COL textiles
- Product abuse or misuse
- Failure resulting from normal wear and tear
- User modification of or attachments to the product
- Products or parts not used, maintained or installed in accordance with the Company's installation, maintenance and/or applicable guidelines
- Products that are exposed to extreme environmental conditions and/or have been subject to improper storage
- Floor samples or display models
- The substitution or use of non-SitOnIt Seating components with SitOnIt Seating products
- Products purchased "as is" and/or secondhand
- Products sold by unauthorized dealers
- Creasing and/or gathering of textiles during upholstery application process
- Minor irregularities of color, surface, grain and texture
- Minor variations of color in textiles
- Variations of texture and natural markings such as neck wrinkles, scratches, backbone marks and stretch marks in leather
- Color matching of textiles exactly to samples, swatches or prior purchases

For orders shipping outside the contiguous 48 U.S. states or the common provinces of Canada (British Columbia, Alberta, Saskatchewan, Manitoba, Ontario, Quebec, New Brunswick & Nova Scotia), we will provide replacement parts and pre-approved labor as determined by our warranty team. However, matching our standard freight policy, we will only ship those replacement parts to a U.S. port. It is up to our dealer to handle freight costs from the U.S. port to their location.

WARRANTY

Applicable Provisions To All Products And Services

The Company will repair or replace with a comparable product, at its option, without charge to the original purchaser, only defective products or parts found defective during the Warranty Period. If requested by the Company, the original purchaser must return the part or product with freight or other shipping charges prepaid.

This warranty shall be effective for the applicable time period beginning from date of purchase as shown on original purchaser's original receipt or other proof of purchase.

For products purchased on or after August 1, 2012, the Company shall pay for all labor costs pre-approved by the Company. The payment of such pre-approved labor costs will be in the form of a credit to an active Company account.

There are no other warranties, expressed or implied, other than those specifically described, including, without limitations, any implied warranty or merchantability or of fitness for a particular purpose. The Company will not be responsible for incidental or consequential damages. Some states do not allow the exclusion or limitation of incidental or consequential damages, so the above limitations or exclusions may not apply to you. This warranty gives you specific legal rights and you may have other rights which vary from state to state.

Warranty claims must be reported within 60 days of any concealed damage. The Company will advise you of the procedure to follow when making warranty claims. Call the Company at the number below to explain the defect. Give your name, address and telephone number. Please be prepared with the model number and sales order number found under the seat of the chair.

SitOnIt Seating: (888) 274-8664

ORDERING INFORMATION

Pricing

All prices are suggested retail and are subject to change without notice. Visit our websites or contact Customer Experience for the latest pricing. Prices in effect at the time of shipment will prevail. We reserve the right to make changes in prices, models, fabrics, finishes, materials and specifications and also discontinue models and options at any time without notice.

Orders

Specify model number, quantity, desired delivery date and all other applicable information. Order templates can be found in the applicable Price Guide. Orders will be accepted with an acknowledgment form governing the transaction. In the event an error is made in the manufacture of the product, the acknowledgment will be used as the resolution document. Submit orders by email or fax:

SITONIT SEATING:

Email: purchaseorder@exemplis.com

Fax: (714) 995-4855

Minimums

FREIGHT PROGRAM

The freight program is designed to deliver freight prepaid to the designated consignee. To offset rapidly increasing costs, it requires a minimum quantity (three or more items) for select product categories. Premium freight services and/or guaranteed delivery may result in additional shipping charges.

NO MINIMUM REQUIREMENT:

- Task/Collaborative/Conference/Executive seating and task stools
- Side, nesting seating and stools
- Plastic seating
- Height adjustable tables (except tops)*
- Fixed and adjustable benches (except tops)*
- Power beam
- Training/meeting/Café/Occasional tables (except tops)*
- Ergonomic accessories (e.g. monitor arms, keyboard trays, wire management, desktop sit-to-stand, power solutions)
- Screens
- Storage
- WFH products

Note: The tops for these products will have a minimum requirement of four units. Uni table ships in a single packet and the top is not subject to minimum four rule.

Minimums (Cont.)

3-UNIT MINIMUM

- Lounge seating
- Tandem seating

Note: Products that do not require a minimum can be combined with those that require 3-unit minimum to reach the minimum quantity. If the minimum is not met, the order will incur a \$95 net surcharge per order.

4-UNIT MINIMUM:

- Tabletops/worksurfaces

Note: Tabletop/worksurface orders that don't reach the minimum of 4 tops will incur a \$95 net surcharge per order even if they're part of a larger order.

EXAMPLES

- Order A: 1 Rio chair, 1 Wit chair, 1 Gobi – no surcharge
- Order B: 1 Gobi, 1 Envoi - \$95 surcharge because the number of lounges is less than minimum 3 and there are no other products in the order
- Order C: 1 Aviera, 1 Mobio arm, 1 Motif screen – no surcharge
- Order D: 1 eBeam, 1 EON, 1 Switchback base, 1 Switchback top - \$95 surcharge because the number of tops is under the required four tops minimum
- Order E: 3 Switchback tables with tops - \$95 surcharge because the number of tops is under the required four tops minimum

Quantity Discounts

Quantity discounts for CAL 133 textiles and some shipping methods are available. See the appropriate Price Guide or contact Customer Experience for more information.

Change Orders

Orders that have been scheduled for production may not be changed. All changes on customer orders previously acknowledged must be requested in writing and are subject to approval. Requests for changes are not deemed accepted until acknowledged. In the event a revision is accepted, change fees may apply.

ORDERING INFORMATION

Lead Time

SitOnIt Seating offers mass customization with millions of product combinations, thousands of fabric and finish options, and multiple product categories—all within our standard offering. Industry-leading speed means our comprehensive solutions ship in just 5 to 10 days. Need real-time lead times for your projects? Visit [sitonit.net/leadtimes](https://www.sitonit.net/leadtimes).

Holds

Orders received by 10 a.m. PST begin assembly the next day. Orders that are “On Hold” will begin production only when all holds are released. Customer Experience will notify you of any holds placed on your order.

Types of holds include:

- Credit Hold for issues related to billing and invoicing.
- Incomplete Hold if the purchase order is incomplete or illegible.
- Pricing Hold if the price on the purchase order does not match the pricing shown in the Price Guide or in our computer system.
- New Fabric Hold for nonstandard textile orders without an inventory part number.
- Graded Hold is placed by the Purchasing Department while confirming delivery of graded fabric from the vendor.

Large Orders

Large orders may require additional lead time:

25 UNITS

- Cameo
- Compositum
- Envoi
- Gobi
- Nano
- Sable
- Visit Modular

50 UNITS

- Aviera
- Benching
- Kindl
- Parallon Bases
- Screens
- Paséa
- Tabletops
- Tensor Bases

100 UNITS

- Flytech
- Sephen

150 UNITS

- Accessories
- Switchback Bases
- Lighting
- Monitor Arms
- Ocala Bases
- Power
- Sit-Stand (Desktop)
- Surge Bases

250 UNITS

- Task Chairs/Stools
- Side Chairs/Stools

ORDERING INFORMATION

Product Modification

Special requests are available and additional charges will be determined per quotation. Up to five working days are required after the special request is received to prepare a quotation. Contact Customer Experience for details.

Orders for Parts

Multiple shipments may occur for orders that include parts. Hardware such as casters or cylinders will ship separately from items requiring upholstery or manufacturing labor. Components such as casters or cylinders will ship separately from new chairs.

Product and Design Changes

We reserve the right to discontinue product lines, models and parts at any time. We also reserve the right to make changes in design and material when such action is deemed to be an improvement in design, function and/or construction.

Cancellation and Returns

Orders that have entered any stage of production cannot be canceled. Request for cancellations are not accepted until acknowledged. In the event a cancellation is accepted, canceled charges may be imposed for the entire amount of the order. Authorization for return must be requested from and approved by Customer Experience prior to the return of the merchandise. Returns may be subject to a restocking charge equivalent to 40% of the net order plus freight. Unauthorized returns will not be accepted.

Shipping

Standard shipments are made via common carrier, unless otherwise specified. Special routing requests or circumstances generated by the customer or the consignee may result in additional charges.

Additional surcharges are referred to as accessorial charges and can arise due to various factors that extend beyond the typical point-to-point transportation.

Examples of such surcharges may include but are not limited to fuel surcharges, residential delivery fees, liftgate services, inside delivery charges and re-delivery fees. Carriers also impose detention fees if the loading process takes longer than the allocated free time they allow. This fee compensates for the carrier's time and resources spent waiting.

Storage fees could also occur under certain circumstances and typically come into play when the consignee is unable to receive the goods promptly upon arrival at the destination. This delay may be due to reasons such as availability, scheduling conflicts, or other issues on the recipient's end. These fees are intended to cover the costs associated with keeping the items in storage, including warehouse space, security, and handling.

Each of these surcharges will vary depending on the carrier that is transporting the order. Please contact Customer Experience to ascertain exactly what these charges are or would be in any of the above circumstances.

Standard deliveries are dock to dock and are scheduled to occur Monday through Friday between 8 a.m. and 5 p.m.

If the delivery location has restricted delivery hours and cannot accept deliveries during normal business hours, Monday through Friday, 8 a.m. and to 5 p.m., this would require a smart delivery quote from Customer Experience. We will not be held responsible for issues or costs arising from carrier transit delays, missed delivery appointments, etc.

We reserve the right to charge for nonstandard customer delivery requirements that may include but are not limited to Residential, Lift Gate, Inside Delivery, Re-Delivery, Detention Fees (if the unloading process exceeds the standard allotted free time) and Storage.

ORDERING INFORMATION

Freight Terms

Freight terms apply to the continental U.S. only. This excludes Alaska and Hawaii. All standard transportation services and freight costs are included in the price of our products. We ship freight prepaid and allowed, FOB and origin.

Shipments outside the contiguous U.S. are shipped to the point of embarkation free of charge, if the shipment meets the minimum requirement. All subsequent freight charges will be at the customer's expense, shipped collect.

Because of the fluctuation of fuel prices, we reserve the right to impose fuel surcharges for any shipments.

Freight Damage

We are not responsible for product damage occurring in transit or during storage. Before accepting a shipment from the carrier, carefully review the packing list and inspect the quantity and condition of the items. Promptly document all visible damage on the Bill of Lading and request a carrier inspection of the product. In the event of damage, accept the order and contact Customer Experience for issue resolution. Concealed damage must be reported in writing within 60 days of accepting delivery. We will take all reasonable steps to assist customers in resolving claims for loss or damage.

Smart Delivery

Smart Delivery provides precise order delivery within a customer-specified date and time window. This special service is available in the contiguous U.S. and includes inside delivery, non-dock delivery, weekend delivery and residential delivery.

Requests must be made prior to an order being scheduled for production. A Smart Delivery fee will be added to the original order invoice. Any changes to a submitted Smart Delivery order will require a new Smart Delivery quote request. Not all change requests can be honored. Changes to an order will result in delays and/or additional costs once the order is in transit.

The Smart Delivery fee will be refunded if the shipment does not arrive within the specified delivery window. We will not be held responsible for costs or damages associated with delayed deliveries.

Please contact Customer Experience to request a Smart Delivery quote or for more information.

Will Call

Customers with Will Call orders will be notified once orders are ready to be picked up. Customers will have three business days from notification to pick up the order. If the order is not picked up within this time frame, storage charges will start at a rate of \$30 per business day until the order has been claimed.

Invoicing

Invoicing is triggered when the product ships.

Fire safety is a top priority for us. SitOnIt Seating strongly supports CAL 133 standards and makes it easy for designers and buyers to specify CAL 133 chairs.

TB 117

Under California law, all upholstered furniture must meet TB 117-2013 by January 1, 2015. At a minimum, all SitOnIt Seating fabrics, vinyl, leathers and resilient filling material (i.e., foam and Dacron) meet TB 117-2013. Unlike TB 117-2013, which tests only the inner upholstery components, with CAL 133 the entire piece of furniture must withstand ignition from a gas burner inside a testing chamber.

What is CAL 133?

CAL 133 is a standard of furniture flammability started by the California Bureau of Home Furnishings and Thermal Insulation for furniture used in public buildings such as healthcare facilities, convalescent homes, public assembly areas of hotels and motels, hospitals, board and care homes, stadiums, licensed child care facilities, prisons and jails.

Notice: Starting January 1, 2020, the State of California changed regulations to ban flame retardants in upholstered furniture sold in California. We anticipate further regulatory changes in other states. The TB-133 barrier material used in our products is a flame-retardant fabric designed to pass open-flame testing protocols. The cotton/fiberglass knit is infused with a phosphorus flame retardant and coated with a chemical that expands in heat to create a physical flame barrier. The TB-133 barrier material that we use in our products is free of halogenated flame retardants, polybrominated diphenyl ethers (PBDE), formaldehyde, and antimony.

Choosing CAL 133 Textiles

Consult the individual [SitOnIt Seating fabric cards](#) to review the specifications for each fabric offered. Because we offer such a vast array of fabrics with varying degrees of flame retardancy, we suggest you consult the published technical data of the fabric supplier when making your fabric selection.

Specify CAL 133 textiles in the Material section of the Final Price Calculation worksheet or on your purchase order.

SitOnIt Seating assumes no responsibility for the flame retardancy of any customer-provided textile.

CAL 133 Testing

CAL 133 is a full-scale fire test for furniture manufactured for use in public buildings. The standards do not specify how to construct furniture, but only how it should perform when tested. To pass this fire standard test, a fire blocking liner is sandwiched between the foam and the fabric of our chairs. This liner acts as a fire extinguisher by smothering the flame.

COM/COL compliance for the CAL 133 models listed on the following page can be determined by specifying upholstery with the exact characteristics as approved SitOnIt Seating fabrics and leathers or by conducting a full chair burn test. The nondiscountable test fee for each chair-textile combination is listed below. The lead time for testing is four weeks.

Task and Side Chairs/Stools: \$600
Lounge: \$800

For more information on TB 117-2013 and CAL 133, visit the [State of California Department of Consumer Affairs](#) website.

To Order CAL 133

Allow a 10-day lead time. Clearly specify CAL 133 on your order. For each chair, add the appropriate additional charge.

CAL 133 Materials

- **CAL 133 LEATHER:** All carded leather is CAL 133 approved.
- **CAL 133 TEXTILES:** Over a thousand CAL 133 approved textiles in all grades, colors and styles are listed on the SitOnIt Seating website. Visit sitonit.net and search textiles by CAL 133 compliance, manufacturer, grade, lead time and other attributes.

To Check Seating for CAL 133

To determine whether your current SitOnIt Seating chair meets CAL 133, or to check an order you have recently received, check the bottom of the chair seat pan for the label shown below. If your chair does not have this tag, your chair does not meet CAL 133.

NOTICE

This Article is manufactured for use in public occupancies and meets the flammability requirement of California Bureau of Home Furnishings technical bulletin 133. Care should be exercised near open flame or with burning cigarettes.

CAL 133 Approved Models

The following models, when combined with approved textiles and blocker, meet the CAL 133 standard.

MULTIPURPOSE CHAIRS AND STOOLS

- Achieve: Upholstered
- Anytime: Upholstered and all plastic colors - A48, A49 (arm and armless)
- Focus Side: Upholstered and all mesh colors - A130 (arm and armless)
- Freelance: Upholstered and all plastic colors (arm and armless)
- InFlex: Upholstered and all plastic colors: A121, A122 (arm and armless)
- Lumin: Upholstered and all plastic colors
- Mika: All models
- Movi: All mesh colors
- Non-Stop Heavy Duty: A67, A68, A69, A70, A71, A72 (arm and armless)
- Qwiz: All models
- ReAlign: A73, A74, A76, A77 (arm and armless)
- Relay: Upholstered and all plastic colors
- Rio: Upholstered and all plastic colors (arm and armless)
- Rowdy: Upholstered and all plastic colors - A47 (arm and armless)
- Wit Side: All mesh colors (arm and armless)

CAL 133 Approved Models

TASK CHAIRS AND STOOLS

- Amplify: Upholstered and all mesh colors
- Focus: A91, A92, A93, A94, A95 (arm and armless)
- Mavic: All models
- Novo: All mesh colors (arm and armless)
- Prava: A105, A106, A108, A109, A111, A112 (arm and armless)
- Sonata: A101, A102, A105, A106, A108, A109 and all knit colors (arm and armless)
- Torsa: All mesh colors (arm and armless)
- TR2: A12FR, A15FR, A17FR, A43FR, A44FR (arm and armless)
- Wit: All mesh colors (arm and armless)

LOUNGE SEATING

- Aviera: Metal and Wood
- Cameo
- Composium
- Envoi
- Gobi
- Nano
- Paséa
- Visit Modular

COM/COL AND TEXTILE TESTING PROCESS

COM/COL Warranty

Any textiles applied to furniture orders through the COM/COL process will not be covered under warranty by SitOnIt Seating. Any warranty claims for these upholstery materials will fall to the original vendor of the fabric. With a broad spectrum of harsh cleaning agents used by facilities, SitOnIt Seating recommends that the owner test each fabric selection with their specific cleaning methods before using. Additionally, SitOnIt Seating is not held responsible for receipt of defective fabrics, as we apply all COM as first-quality goods.

CAL 117 Policy

SitOnIt Seating assumes no responsibility for the fire retardancy of any COM/COL. Customers are solely responsible for making sure that their COM/COL complies with all applicable codes and regulations. For information on CAL 133, refer to page .

Excess Yardage

SitOnIt Seating is not responsible for yardage submitted to us beyond the required amount. Excess materials will be discarded at the discretion of SitOnIt Seating unless otherwise instructed by the customer at the time the order is placed. If a customer requires the excess yardage returned, they must contact Customer Experience to make arrangements. The customer will be responsible for delivery charges.

Textile Testing Process

1. Visit the [SitOnIt Seating Textile Compatibility](#) tab on our website to see if your textile has already been approved.

(If your textile is already approved, skip to step 3.
If it hasn't been previously approved, go to step 2.)

2. Send a 12" x 12" textile swatch to be tested for approval along with a completed Textile Test Request Form found on the next page.

Note Exceptions:

2 yards for testing: Axys, Billo, Clova, and Cotton Midback/Highback

1 yard for testing: Achieve Back, Cora, Focus Side Back, Freelance Back, InFlex Back, Mika, Motif, Movi, Ozmo, and all other lounge products

Allow up to five business days once your textile is received for the test results to be available on the [SitOnIt Seating Textile Compatibility](#) tab on our website.

Send the textile swatch and form to:

SITONIT SEATING

Attn: COM Engineer

SO#: _____ or Customer PO#: _____

6280 Artesia Blvd.

Buena Park, CA 90620

(714) 995-4800

3. If the swatch is approved, fill out the Upholstery Direction Form located on [page 17](#). and attach with your order.
4. Ship the necessary amount of material and your PFAS compliant certificate to:

SITONIT SEATING

Attn: COM Engineer

SO#: _____ or Customer PO#: _____

6280 Artesia Blvd.

Buena Park, CA 90620

(714) 995-4800

COM/COL fabric must have an Exemplis SO# and/or Customer PO# labeled on it at the time of Receiving or it will delay the processing of the order.

5. Send Textile Test Request Form via email to sitonit@exemplis.com

TEXTILE TEST REQUEST FORM

For all COM/COL and graded textiles that require testing, please allow five business days after fabric is delivered for test results to be available on the [SitOnIt Seating Textile Compatibility](#) tab of our website. If you need further assistance, please contact Customer Experience at (888) 274-8664.

Please complete one form for each model and/or textile that needs to be tested.

Contact Information

Dealer: _____ Contact Name: _____
Address: _____ City: _____ State: _____ Zip: _____
Phone: _____ Fax: _____ Email: _____

Product Information

Product Name: _____ Model Number: _____

Textile Information

Manufacturer: _____ Pattern: _____ Colorway: _____

Shipping Information

Carrier: _____
Tracking #: _____
SO#: _____ or Customer PO#: _____

The textiles and this form can be sent to:

SITONIT SEATING

Attn: COM Engineer

SO#: _____ or Customer PO#: _____

6280 Artesia Blvd.

Buena Park, CA 90620

(714) 995-4800

Unmatched Matching®

Textiles can be everything. With the right fabrics, you can provide atmosphere, create cohesiveness and offer an unforgettable experience across many spaces and places.

Fabric color, alignment, texture, orientation and pattern all play a part—and need to line up or match perfectly (especially with field-replaceable parts). With PatternMatch and pattern orientation, you can rest assured that every part of every chair can be traded out easily without disrupting design.

PatternMatch®

We ensure that design elements of the back, seat and arms match and/or align between seat and back. The patterns or lines also match unit-to-unit.

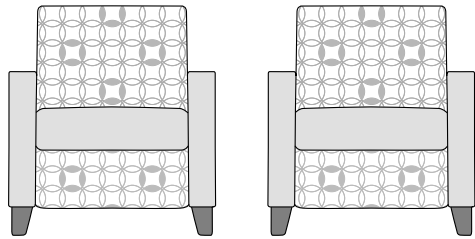

Pattern Orientation

All fabric (vertical, horizontal or bi-directional pattern) will be applied in the direction shown on the fabric manufacturer's website, unless otherwise specified.

To ensure desired fabric direction, use the Upholstery Direction Form on page 17 and check the appropriate box under the "Pattern Orientation" section.

When we apply a textile pattern with lines at a 90-degree angle (vertically and/or horizontally) to the back and seat of a chair, we strive to achieve full alignment. Some small variations can occur due to the shape and size of the product. Pattern Orientation is standard for SitOnIt Seating.

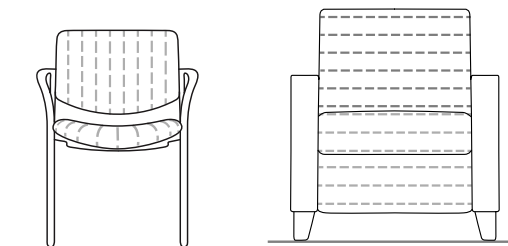

Multi-Upholstery

The multi-upholstery option allows one fabric to be selected for the back and a different fabric for the seat. Multi-upholstery lounge pricing is different than multi-upholstery pricing for task and side seating.

Task and Side

- Upholstery pricing is based on both seat and back being the same textile. If the material is COM/COL or more than one textile is used:
 - If two fabrics of the same grade are chosen,** one grade level will be added to the upholstery price. Example: grade 4 for the seat and a different grade 4 for the back, the upholstery price will be grade 5 for both.
 - If two fabrics of different grades are chosen,** the final upholstery price will be based on the highest grade. Example: grade 2 for the seat and grade 3 for the back, the upholstery price will be grade 3 for both.

The above upcharges only apply to chairs that have both the seat and back upholstered.

Lounge and cora

- A standard upcharge applies to all multi-upholstery orders. Different fabrics and grades may be combined because each back, seat, arm and valance are separately priced.
- Add the single multi-upholstery upcharge to the cost of the components. Example: upcharge + any grade price for the seat + any grade price for the back + any grade price for the arm.

Moisture Barrier

Accidents happen. To help protect your investment, moisture barrier for seats and backs is an option on all lounge seating products.

Specify moisture barrier seats and/or backs in the Material section of the Final Price Calculation worksheet or on your purchase order. Note that specification and pricing are separate for seat and back and apply to each single seat or back position.

UPHOLSTERY DIRECTION FORM

For all COM/COL orders or orders with custom textile upholstery directions, please complete one form for each model and/or textile.

Contact Information

Dealer _____
 Address _____
 Phone _____ Fax _____

Contact Name _____
 City _____ State _____ Zip _____
 Email _____

Order Information

Purchase Order Number _____

Sales Order Number _____

Product Information

Product Name _____

Model Number _____ Quantity _____

Textile Information

Manufacturer _____

Pattern _____ Colorway _____

Total Yardage Calculated (for COM/COL) _____

Total Yardage Shipped (for COM/COL) _____

(To calculate, reference COM Calculation and COM Yardage Requirement beginning on 22.)

Contains flame retardants: Yes No
Prop 65 compliant: Yes No
PFAS compliant (AB1817): Yes No

Per California Proposition 65, we are required to note that select textiles may contain chemicals known to cause cancer or reproductive toxicity. To learn more, please visit the Prop 65 web page.

Fabric Direction

To avoid confusion, you may wish to attach a sample textile with the desired face and direction indicated. Is there a desired top and bottom to the fabric application?

Yes No

Is the fabric either a stripe or two-color plaid?

Yes No

Please refer to our standard and rotated fabric directions to the right. Indicate the desired fabric direction for each applicable component below.

Seat (Ottoman Chassis): Vertical Horizontal
Back (Ottoman Top): Vertical Horizontal
Arm: Vertical Horizontal
Valance: Vertical Horizontal

Please attach this form with your order submission. If you are submitting a COM/COL order, make sure to include your PO# with the textile that you mail to our factory:

SITONIT SEATING

Attn: COM Engineer
 6280 Artesia Blvd., Buena Park, CA 90620

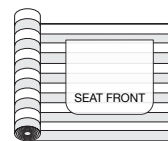
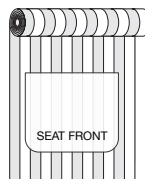

Vertical or Off the Roll

Horizontal or Railroaded

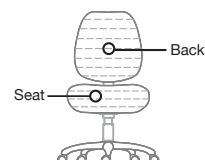
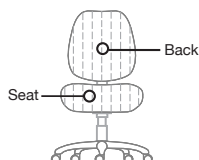
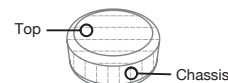
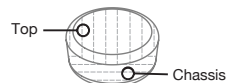
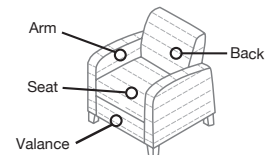
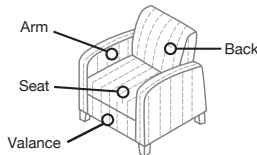

COM CALCULATION

Steps to Calculate COM Yardage.

1. Determine which products are being ordered as COM.
2. Find the yardage needed to upholster those products from the COM Yardage Requirement charts.
3. Adjust the yardage requirement total based on the repeat of the fabric roll using the COM Repeat Calculation table.
4. Take the final calculation and round up to the nearest half-yard to get final yardage.

For orders of 10 or more seats, contact Customer Experience for further quoting.

COM Repeat Calculation.

Use the guide below to calculate the percentage of extra upholstery required to cover large repeats.

Repeat	Railroaded/Horizontal OR Vertical/Off The Roll
5.1"– 7"	10%
7.1"–10"	15%
10.1"–14"	20%
14.1"–20"	30%
20.1"–27"	45%

Yardage requirements listed in this document are based on textile bolts/rolls that are 54" wide. Please contact Customer Experience if goods are a width other than 54".

COM Calculation Example

Below is a hypothetical scenario for how total COM yardage should be determined. This example is for a patterned textile that has a repeat.

STEP 1: DETERMINE WHICH PRODUCTS ARE BEING ORDERED AS COM

For this example order, we'll assume we need to order: 20 units of Freelance 4-leg—backs only.

STEP 2: DETERMINE THE COM YARDAGE REQUIREMENT

Looking at the COM Yardage Requirements chart that begins on [page 22](#), we see that the following yardage amounts are needed for each product:

Freelance 4-leg chair back = 0.94 yards.

Now we multiply 0.94 yards by the 20 chair backs and we get a total of 18.8 yards.

STEP 3: ADJUST THE YARDAGE REQUIREMENT TOTAL BASED ON REPEAT

Since the textile we've chosen is a pattern with a repeat, we should look at the COM Repeat Calculation table to determine our multiplier. For this example, let's assume our repeat is 11" and we're upholstering the fabric vertical/off-the-roll. Based on the table, the multiplier is 20%. Now, we need to take the 18.8 yards from step two and increase it by 20%. An easy way to calculate this is by multiplying 18.8 by 1.2, which gives us 22.6 yards.

STEP 4: ROUND TO GET THE FINAL AMOUNT NEEDED

To determine how much yardage is needed to complete this order, we take the amount from step three and round it to the nearest half-yard. In this case, that means the customer needs to send SitOnIt Seating 23 yards to complete this order.

COM/COL YARDAGE: MULTIPURPOSE AND SIDE

Combining upholstery is an option on all SitOnIt Seating upholstered products. Below are tables outlining the fabric or vinyl requirements for the entire chair as well as individual pieces. All yardage requirements are quoted in terms of yards for fabric or vinyl and square feet for leather. Please contact Customer Experience for order quantities greater than 10 seats.

Achieve

	Fabric/Vinyl			Leather		
	Seat and Back	Seat Only	Back Only	Seat and Back	Seat Only	Back Only
Plastic Back	—	1 yd	—	—	17 sq ft	—
Upholstered Back	1.75 yd	1 yd	1 yd	30 sq ft	17 sq ft	15 sq ft

Anytime

	Fabric/Vinyl			Leather		
	Seat and Back	Seat Only	Back Only	Seat and Back	Seat Only	Back Only
Multipurpose	1 yd	0.8 yd	0.75 yd	15 sq ft	10 sq ft	8 sq ft
Bar Stool	1 yd	0.8 yd	0.75 yd	15 sq ft	10 sq ft	8 sq ft

Baja

	Fabric/Vinyl			Leather		
	Seat and Back	Seat Only	Back Only	Seat and Back	Seat Only	Back Only
Multipurpose	1 yd	0.75 yd	—	—	—	—
Bar Stool (Standard Back)	1 yd	0.75 yd	—	—	—	—
Bar Stool (Low Back)	0.75 yd	0.75 yd	—	—	—	—

Clova

	Fabric/Vinyl			Leather		
	Seat and Back	Seat Only	Back Only	Seat and Back	Seat Only	Back Only
Guest Chair	2.25 yd	1.75 yd	1.25 yd	40 sq ft	32 sq ft	20 sq ft
Side Chair	2.25 yd	1.75 yd	1.25 yd	40 sq ft	32 sq ft	20 sq ft

Cora

	Fabric/Vinyl			Leather		
	Seat and Back	Seat Only	Back Only	Seat and Back	Seat Only	Back Only
Guest	1.25 yd	0.9 yd	0.75 yd	21 sq ft	14 sq ft	12 sq ft
Midsized	1.75 yd	1 yd	0.95 yd	27 sq ft	17 sq ft	15 sq ft
Bariatric	2 yd	1.25 yd	1.25 yd	30 sq ft	21 sq ft	18 sq ft

COM/COL YARDAGE: MULTIPURPOSE AND SIDE

Flytech

	Fabric/Vinyl			Leather		
	Seat and Back	Seat Only	Back Only	Seat and Back	Seat Only	Back Only
Stacking Nester	1.25 yd	0.75 yd	–	–	–	–

Focus Side

	Fabric/Vinyl			Leather		
	Seat and Back	Seat Only	Back Only	Seat and Back	Seat Only	Back Only
Multipurpose Mesh/Wood	–	1 yd	–	–	17 sq ft	–
Multipurpose Upholstered	1.25 yd	1 yd	0.75 yd	20 sq ft	12 sq ft	10 sq ft
Counter and Bar Stool Mesh/Wood	–	1 yd	–	–	17 sq ft	–
Counter and Bar Stool Upholstered	1.25 yd	1 yd	0.75 yd	20 sq ft	12 sq ft	10 sq ft

Freelance

	Fabric/Vinyl			Leather		
	Seat and Back	Seat Only	Back Only	Seat and Back	Seat Only	Back Only
Multipurpose/Sled	1.25 yd	0.99 yd	1 yd	25 sq ft	15 sq ft	–
Multipurpose/Sled Ballistic Nylon	1.15 yd	0.99 yd	0.9 yd	21 sq ft	15 sq ft	–
Bariatric (30")	2.25 yd	1 yd	1.35 yd	40 sq ft	20 sq ft	–
Bariatric (30") Ballistic Nylon	1.67 yd	1 yd	1 yd	30 sq ft	20 sq ft	–
Bariatric (42")	2.5 yd	1.25 yd	1.5 yd	42 sq ft	25 sq ft	–
Bariatric (42") Ballistic Nylon	1.75 yd	1.25 yd	1.25 yd	40 sq ft	25 sq ft	–
Counter and Bar Stool	1.25 yd	0.99 yd	1 yd	25 sq ft	15 sq ft	–
Counter and Bar Stool Ballistic Nylon	1.15 yd	0.9 yd	1 yd	21 sq ft	15 sq ft	–

Inflex

	Fabric/Vinyl			Leather		
	Seat and Back	Seat Only	Back Only	Seat and Back	Seat Only	Back Only
Multipurpose	1 yd	0.85 yd	0.65 yd	15 sq ft	10 sq ft	7 sq ft
Counter and Bar Stool	1 yd	0.85 yd	0.65 yd	15 sq ft	10 sq ft	7 sq ft

Ioniq

	Fabric/Vinyl			Leather		
	Seat and Back	Seat Only	Back Only	Seat and Back	Seat Only	Back Only
Multipurpose Chair	–	0.75 yd	–	–	7 sq ft	–

COM/COL YARDAGE: MULTIPURPOSE AND SIDE

Lumin

	Fabric/Vinyl			Leather		
	Seat and Back	Seat Only	Back Only	Seat and Back	Seat Only	Back Only
Multipurpose	1 yd	0.85 yd	0.65 yd	15 sq ft	10 sq ft	7 sq ft
Wire Rod	1 yd	0.85 yd	0.65 yd	15 sq ft	10 sq ft	7 sq ft
Counter and Bar Stool	1 yd	0.85 yd	0.65 yd	15 sq ft	10 sq ft	7 sq ft

Mika

	Fabric/Vinyl			Leather		
	Seat and Back	Seat Only	Back Only	Seat and Back	Seat Only	Back Only
4-Leg	—	0.85 yd	—	—	—	—
Wire Rod	—	0.85 yd	—	—	—	—
Counter and Bar Stool	—	0.85 yd	—	—	—	—

Movi

	Fabric/Vinyl			Leather		
	Seat and Back	Seat Only	Back Only	Seat and Back	Seat Only	Back Only
Nester	—	0.75 yd	—	—	10 sq ft	—

Orbix

	Fabric/Vinyl			Leather		
	Seat and Back	Seat Only	Back Only	Seat and Back	Seat Only	Back Only
Multipurpose	—	0.75 yd	—	—	—	—
Bar Stool	—	0.75 yd	—	—	—	—

Qwiz

	Fabric/Vinyl			Leather		
	Seat and Back	Seat Only	Back Only	Seat and Back	Seat Only	Back Only
Nester	1 yd	0.75 yd	—	—	—	—

Relay

	Fabric/Vinyl			Leather		
	Seat and Back	Seat Only	Back Only	Seat and Back	Seat Only	Back Only
Nester	1 yd	0.75 yd	0.6 yd	15 sq ft	12 sq ft	10 sq ft

COM/COL YARDAGE: MULTIPURPOSE AND SIDE

Rio

	Fabric/Vinyl			Leather		
	Seat and Back	Seat Only	Back Only	Seat and Back	Seat Only	Back Only
Multipurpose	1 yd	0.85 yd	0.65 yd	15 sq ft	10 sq ft	7 sq ft
Wire Rod	1 yd	0.85 yd	0.65 yd	15 sq ft	10 sq ft	7 sq ft
Counter and Bar Stool	1 yd	0.85 yd	0.65 yd	15 sq ft	10 sq ft	7 sq ft

Rowdy

	Fabric/Vinyl			Leather		
	Seat and Back	Seat Only	Back Only	Seat and Back	Seat Only	Back Only
Wire Rod	—	0.75 yd	—	—	13 sq ft	—

Wit Side

	Fabric/Vinyl			Leather		
	Seat and Back	Seat Only	Back Only	Seat and Back	Seat Only	Back Only
Multipurpose	—	0.75 yd	—	—	10 sq ft	—

CUSTOM FINISH PROGRAM

Pricing

First-time custom stains must be approved before acceptance of an order. A one-time set-up fee applies. Thereafter, a stain-to-match upcharge is applied to each chair.

LOUNGE

One-time set-up fee: \$275

Stain-to-match upcharge: \$70 List

Ordering

When ordering, enter the approved STAIN ID# in the Material section of the Final Price Calculation worksheet or on your purchase order.

Custom Finish Terms and Conditions

Wood is inherently beautiful because of natural variations in color, grain and texture. There may be minor differences from one chair to the next, even though they are finished at the same time. We cannot guarantee exact matches of grain or natural wood color.

Approval Process

Since all new stains must be approved before they can be applied to seating or tables, allow extra time for custom finishes. Custom finishes generally require at least one to two weeks to create a matched sample. We will need a signed Approval Form before we can accept your order. We reserve the right to decline the opportunity to match a finish color.

1. Send a 3" x 4" or 4" x 6" sample of the stain, along with the model numbers and options to which the finish will be applied, to:

Customer Experience
Custom Finish Program
6415 Katella Avenue
Cypress, CA 90630

Include dealer name, contact and project reference.

2. Once approved, we will send a finish sample to you along with any caveats that may apply. We will keep an identical sample in our files for future orders. Custom finishes generally require at least a week to create a matched sample.
3. Carefully review the sample. Note the STAIN ID# (example: SM#070214-1); this will be needed for your order. Return the signed approval form to Customer Experience along with your order. We need your approval before we can accept the order, schedule it for production or acknowledge a ship date.
4. Lounge orders using our stain-to-match program will have a lead time of 15 days.

Chairs and Stools

MULTIPURPOSE | SIDE | GUEST | BARIATRIC
COUNTER STOOL | BAR STOOL

Statement of Line

MULTIPURPOSE | SIDE | GUEST | BARIATRIC
COUNTER STOOL | BAR STOOL



Achieve
Multipurpose Chair
91
Page 28



Anytime
Multipurpose Chair
93
Page 31



Anytime
Multipurpose Chair
93 S2
Page 31



Axyx
Guest Chair
2101 S0 FT2
Page 35



Axyx
Lounge
2105 FT2
Page 35



Axyx
Counter Stool
2101 S9
Page 35



Axyx
Bar Stool
2101 S2
Page 35



Baja
4-Leg Chair
1171 FT1
Page 38



Baja
Wire Rod Chair
1171 FT2
Page 38



Baja
Bar Stool
1171 FT2 S2 BK4
Page 38

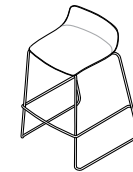

Baja
Low Back Bar Stool
1171 FT2 S2 BK3
Page 38



Clova
Guest (4-Star)
2050
Page 43



Clova
Side (4-Leg)
2051
Page 46



Cora
Guest
1191 SW19
Page 49



Cora
Midsize
1191 SW26
Page 49



Cora
Bariatric
1191 SW30
Page 49



Cora
Counter Stool
1191 SW19 S9
Page 49

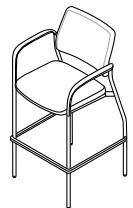

Cora
Bar Stool
1191 SW19 S2
Page 49

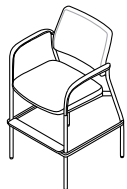

Cora
Hip Chair
1191 SW19 S4
Page 49



Flytech
Plastic Stacking Nester
1651 FT4 PS PB
Page 55



Flytech
Mesh Back Stacking Nester
1651 FT4 PS MB
Page 55



Flytech
Upholstered Stacking Nester
1651 FT4 US UB
Page 55



Focus Side
Wood Back Chair
5651/ 5652 WB1/WB2
Page 59

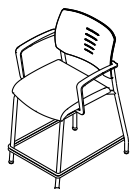

Focus Side
Wood Back Counter Stool
5651/ 5652 WB1/WB2 S9
Page 59

Statement of Line

MULTIPURPOSE | SIDE | GUEST | BARIATRIC
COUNTER STOOL | BAR STOOL



Focus Side

Wood Back Bar Stool
5651/5652 WB1/WB2 S2
Page 59



Focus Side

Upholstered Chair
5651/ 5652 B3
Page 59



Focus Side

Upholstered Counter Stool
5651/ 5652 B3 S9
Page 59



Focus Side

Upholstered Bar Stool
5651/ 5652 B3 S2
Page 59



Focus Side

Mesh Back Chair
5651/ 5652 B1
Page 59



Focus Side

Mesh Back Counter Stool
5651/ 5652 B1 S9
Page 59

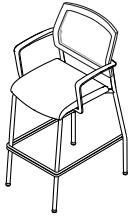

Focus Side

Mesh Back Bar Stool
5651/ 5652 B1 S2
Page 59



Freelance

4-Leg Multipurpose Chair
521X
Page 64



Freelance

Counter Stool
5214 S9
Page 64



Freelance

Bar Stool
5214 S2
Page 64

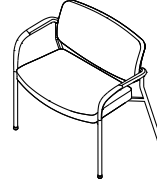

Freelance

30° Bariatric
5314
Page 70

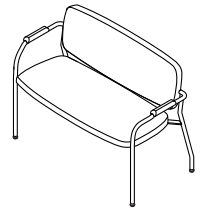

Freelance

42° Bariatric
5414
Page 70



InFlex

4-Leg Chair
971
Page 73

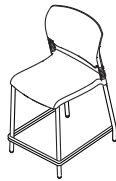

InFlex

Counter Stool
971 S9
Page 73

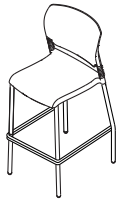

InFlex

Bar Stool
971 S2
Page 73



Ioniq

4-Leg Multipurpose Chair
1151 FT1
Page 77



Lumin

Wire Rod Chair
1011 FT2
Page 79



Lumin

4-Leg Chair
1011 FT1
Page 79



Lumin

Counter Stool
1011 FT1 S9
Page 79



Lumin

Bar Stool
1011 FT1 S2
Page 79



Mika

Wire Rod Chair
1101 FT2
Page 84



Mika

4-Leg Chair
1101 FT1
Page 84



Mika

Counter Stool
1101 FT2 S9
Page 84

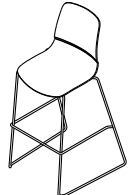

Mika

Bar Stool
1101 FT2 S2
Page 84

Statement of Line

MULTIPURPOSE | SIDE | GUEST | BARIATRIC
COUNTER STOOL | BAR STOOL



Movi

Mesh Back Nester
1061 FT4 MB
Page 88



Movi

Upholstered Back Nester
1061 FT4 UB
Page 88



Orbix

Wire Rod Chair
1131 FT2
Page 92



Orbix

Wire Rod Bar Stool
1131 FT2 S2
Page 92



Qwiz

Plastic Back Nester
1141 FT4 PB
Page 96



Qwiz

Mesh Back Nester
1141 FT4 MB
Page 96



Qwiz

Upholstered Back Nester
1141 FT4 UaB
Page 96



Relay

Nester
94XB/ 94XS
Page 100



Rio

Wire Rod Chair
1051 FT2
Page 103



Rio

4-Leg Chair
1051 FT1
Page 103



Rio

24" Counter Stool
1051 FT1 S9
Page 103

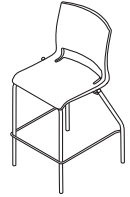

Rio

30" Bar Stool
1051 FT1 S2
Page 103

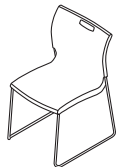

Rowdy

Wire Rod Chair
92 SB/SC
Page 107



Sprout

Wire Rod Chair
1181 FT2
Page 110



Wit Side

Mesh Back Chair
2221 FT1 MB
Page 113



Wit Side

Thintex Back Chair
2221 FT1 TXB
Page 116

Achieve

MULTIPURPOSE CHAIR

Own the space.

Achieve upholstered and plastic side chairs provide the feel of a large chair but with a clean and slender profile. The concave back and contoured seat match the natural curves of the human body, combining comfortable ergonomic support with eye-catching contemporary design. The plastic model's perforated back allows the body to breathe, keeping the user cool while seated.



Good
Featured with SitOnIt Seating's Venice — Gold Dusk

EFFECTIVE FEBRUARY 23, 2026

Featured Models

GOOD :: \$634

4-leg chair, plastic back and upholstered seat, armless, standard multi-surface glides, grade 1 textile

BETTER :: \$748

4-leg chair, upholstered seat and back, fixed loop arms, standard multi-surface glides, grade 1 textile

BEST :: \$788

4-leg chair, upholstered seat and back, fixed loop arms, carpet casters, grade 1 textile

Features

- Clean and contemporary, ideal for guest and lobby areas, meeting and conference rooms
- Fully upholstered or plastic back with upholstered seat
- Generously proportioned contoured design follows the curves of the body
- Waterfall seat promotes proper leg circulation
- Wall-saver anti-tip frame design
- Additional seat foam option
- 250 lb weight capacity warranty



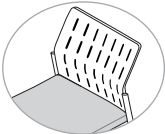
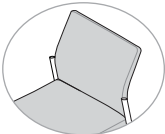

1. Back

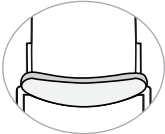
Back and Seat Style	Code	Price	
Black Plastic Back, Upholstered Seat	91 US	\$683	
Upholstered Seat and Back	91 UP	\$748	

2. Seat

Seat Options	Code	Price	
1" Additional Foam	F1	+ \$36	

3. Frame

Frame Finish and Style	Code	Price	
Black	FB	+ \$0	
Silver	FS	+ \$0	
Black With Black Carpet Casters	FCB	+ \$40	
Silver With Black Carpet Casters	FCS	+ \$40	

MULTIPURPOSE CHAIR

4. Base

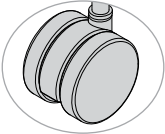
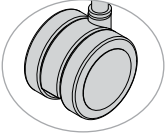
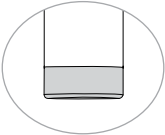
Casters or Glides	Code	Price	
Casters			
Carpet Casters	C13	+ \$0	
Hard Floor and Carpet Casters	C12	+ \$40	
Glides			
Standard Multi-Surface Glides	G6	+ \$0	

Please use caution when stacking models with casters to prevent frame damage. SitOnIt Seating does not warrant scratched frames.

5. Arms

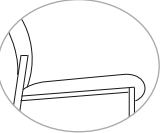
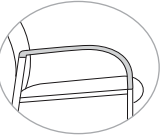
Arm Style	Code	Price	
Armless	A0	- \$49	
Fixed Loop	A40	+ \$0	

6. Miscellaneous

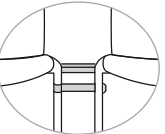
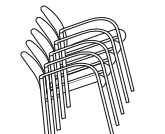
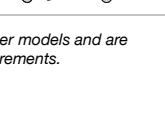
Accessories	Code	Price	
Ganging Bracket for Armless Models	GG4	+ \$30	
Ganging Bracket for Models With Arms	GA4	+ \$30	
Stacking Cart	14-Cart	+ \$399	

Ganging brackets and stacking carts are not intended for use with caster models and are compatible with glides only. See page 127 for additional stacking requirements.

7. Material

Protection	Code	Price
Fire Retardancy		
CAL 133, Fabric, Quantities 1–49	133F	+ \$99
CAL 133, Fabric, Quantities 50+	133F5	+ \$55
CAL 133, Leather, Any Quantity	133L	+ \$119

Textile	Code	Price
Seat Textile (For US)		
Fabric/Vinyl Grade 1	FG1/VG1	+ \$0
COM	COM	+ \$24
Fabric/Vinyl Grade 2	FG2/VG2	+ \$24
Fabric/Vinyl Grade 3	FG3/VG3	+ \$45
Fabric/Vinyl Grade 4	FG4/VG4	+ \$77
Fabric/Vinyl Grade 5	FG5/VG5	+ \$116
Fabric/Vinyl Grade 6	FG6/VG6	+ \$159
Fabric/Vinyl Grade 7	FG7/VG7	+ \$200
Leather Grade 1	LG1	+ \$140
COL	COL	+ \$200
Leather Grade 2	LG2	+ \$200
Leather Grade 3	LG3	+ \$280

Seat and Back (For UP)		
Fabric/Vinyl Grade 1	FG1/VG1	+ \$0
COM	COM	+ \$36
Fabric/Vinyl Grade 2	FG2/VG2	+ \$36
Fabric/Vinyl Grade 3	FG3/VG3	+ \$74
Fabric/Vinyl Grade 4	FG4/VG4	+ \$121
Fabric/Vinyl Grade 5	FG5/VG5	+ \$174
Fabric/Vinyl Grade 6	FG6/VG6	+ \$235
Fabric/Vinyl Grade 7	FG7/VG7	+ \$296
Leather Grade 1	LG1	+ \$260
COL	COL	+ \$320
Leather Grade 2	LG2	+ \$320
Leather Grade 3	LG3	+ \$400

Please reference the [Textile Reference Guide](#) for pricing on fabric over grade 7 and leather over grade 3. Additional CAL 133 information can be found on [page 12](#).

Please reference the [Fabric information](#) found on [page 18](#) for pricing on multi-upholstery.

MULTIPURPOSE CHAIR

8. Packaging

Packaging	Code	Price
Fully Assembled In a Carton	AC3	+ \$0
Fully Assembled In a Carton, Individually Packaged	AC1	+ \$20

SPECIFICATIONS

Model:	91 Multipurpose Chair
Dimensions	
Overall Width Armless	22"
Overall Width With Arms	25"
Overall Depth	24"
Overall Height	33.5"
Seat Width	19.5"
Seat Depth	19"
Seat Height	18"
Back Width	18"
Back Height	16"
Materials	
COM	1 yd (US), 1.75 yd (UP)
COL	17 sq ft (US), 30 sq ft (UP)
Stacking	
Max Cart Stacking	5
Max Floor Stacking	4
Weight and Capacity	
Weight Armless	18 lb
Weight With Arms	21 lb
Weight Capacity Warranty	250 lb

Upholstered seat only (US). Upholstered seat and back (UP).

Anytime

MULTIPURPOSE CHAIR AND BAR STOOL

Grab and go. Anywhere.

The economical Anytime collection was designed for corporate, government and educational settings where flexibility and style are key requirements. The perforated plastic back provides ample ventilation and upholstered pads can be added for increased comfort. You can specify Anytime as fully upholstered or with an upholstered seat only. Frame colors are either black or silver. The pull handle ensures that the Anytime side chair is ready to go anytime and anywhere it is needed.



Good
Featured with a Navy shell

EFFECTIVE FEBRUARY 23, 2026

Featured Models

GOOD :: \$368

4-leg chair, all plastic, armless, standard multi-surface glides

BETTER :: \$433

4-leg chair, upholstered seat, plastic back, armless, standard multi-surface glides



BEST :: \$556

4-leg chair, upholstered seat and back, fixed arms, standard multi-surface glides

Features

- Fully upholstered, upholstered seat or plastic
- Three plastic colors
- Perforated shell provides ventilation
- Built-in pull handle
- Black or silver tubular frame
- Stacks six on the floor; eight on the optional cart
- 250 lb weight capacity warranty
- Complements Anytime light task chair and stool; see [page 59](#)

1. Back

Back and Seat Style	Code	Price	
Plastic	No Code	\$368	
Upholstered Seat Only	US	\$433	
Upholstered Seat and Back	UP	\$498	

2. Frame

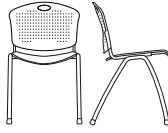
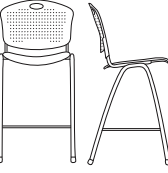
Frame Type	Code	Price	
4-Leg	93	+ \$0	
30" Bar Stool	93 S2	+ \$150	



Bar stools (S2) are available with glides only.

MULTIPURPOSE CHAIR AND BAR STOOL

2. Frame (Cont.)

Frame Finish	Code	Price	
Black	FB	+ \$0	
Black With Casters	FCB	+ \$40	
Silver	FS	+ \$0	
Silver With Casters	FCS	+ \$40	

3. Arms

Arm Style	Code	Price	
Armless	A0	+ \$0	
Fixed Loop Arms (Black)	A48	+ \$58	
Fixed Loop Arms (Silver)	A49	+ \$58	

4. Base

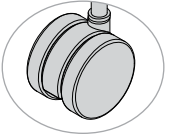
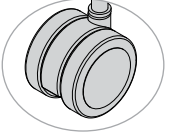
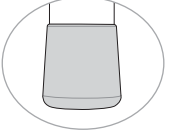
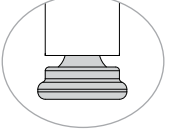
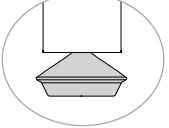
Casters or Glides	Code	Price	
Casters			
Carpet Casters	C13	+ \$0	
Hard Floor and Carpet Casters	C12	+ \$40	
Glides			
Standard Multi-Surface Glides	G7	+ \$0	
Floor Saver Glides	G15	+ \$20	
Steel Glides (Carpet Only)	G14	+ \$20	
Performance Multi-Surface Glides	GL2	+ \$20	

Casters not available with bar stool (S2). Do not stack chairs with casters.

5. Miscellaneous

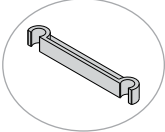
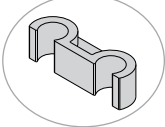
Ganging	Code	Price	
Ganging Bracket for Armless Models	GG6	+ \$30	
Ganging Bracket for Models With Arms	GA6	+ \$30	

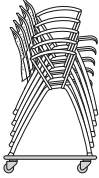
Stacking	Code	Price	
Stacking Cart	93-Cart	+ \$399	

Ganging brackets and stacking carts are not available for caster models and are only available for chairs with glides.

Due to the nature of upholstery, stacking may cause impressions on the seat. SitOnIt Seating does not warrant the effects of stacking on upholstery.

See [page 127](#) for additional stacking requirements.



Best
Featured with a Slate frame and
SitOnIt Seating's Dash — Sky

MULTIPURPOSE CHAIR AND BAR STOOL

6. Material

Protection	Code	Price	
Fire Retardancy			
CAL 133, Fabric, Quantities 1–49	133F	+ \$99	
CAL 133, Fabric, Quantities 50+	133F5	+ \$55	
CAL 133, Plastic, Any Quantity	133P	+ \$45	
Shell Color			
Black	SC1	+ \$0	
Navy	SC5	+ \$0	
Slate	SC8	+ \$0	
Textile			
Seat Only (For US)			
Fabric/Vinyl Grade 1	FG1/VG1	+ \$0	
COM	COM	+ \$24	
Fabric/Vinyl Grade 2	FG2/VG2	+ \$24	
Fabric/Vinyl Grade 3	FG3/VG3	+ \$45	
Fabric/Vinyl Grade 4	FG4/VG4	+ \$77	
Fabric/Vinyl Grade 5	FG5/VG5	+ \$116	
Fabric/Vinyl Grade 6	FG6/VG6	+ \$159	
Fabric/Vinyl Grade 7	FG7/VG7	+ \$200	
Seat and Back (For UP)			
Fabric/Vinyl Grade 1	FG1/VG1	+ \$0	
COM	COM	+ \$36	
Fabric/Vinyl Grade 2	FG2/VG2	+ \$36	
Fabric/Vinyl Grade 3	FG3/VG3	+ \$74	
Fabric/Vinyl Grade 4	FG4/VG4	+ \$121	
Fabric/Vinyl Grade 5	FG5/VG5	+ \$174	
Fabric/Vinyl Grade 6	FG6/VG6	+ \$235	
Fabric/Vinyl Grade 7	FG7/VG7	+ \$296	

Please reference the [Textile Reference Guide](#) for pricing on fabric over grade 7. Additional CAL 133 information can be found on [page 12](#).

Please reference the Fabric information found on [page 18](#) for pricing on multi-upholstery.

7. Packaging

Packaging	Code	Price	
Fully Assembled In a Carton	AC	+ \$0	
Fully Assembled In a Carton, Individually Packaged	AC1	+ \$20	

EFFECTIVE FEBRUARY 23, 2026 | GSA SIN #: 33721

SPECIFICATIONS

Model:	93 4-Leg Multipurpose	93 S2 30" Bar Stool
Dimensions		
Overall Width Armless	21.5"	22"
Overall Width With Arms	26.5"	27"
Overall Depth	22"	22"
Overall Height	32.5"	44"
Seat Width	19"	19"
Seat Depth	18"	18"
Seat Height	18"	30.5"
Back Width	21.5"	21.5"
Back Height	14.5"	14.5"
Materials		
COM	0.8 yd (US) 1 yd (UP)	0.8 yd (US) 1 yd (UP)
Stacking		
Max Cart Stacking	8	N/A
Max Floor Stacking	6	N/A
Weight and Capacity		
Weight Armless	14 lb	21.5 lb
Weight With Arms	18 lb	25.5 lb
Weight Capacity Warranty	250 lb	250 lb

Upholstered seat (US). Upholstered seat and back (UP).



Better
Featured with a Black shell and
SitOnIt Seating's Huntington Tropical

Axys

GUEST, LOUNGE, BAR AND COUNTER STOOL

Unlimited Axys.

Take your space anywhere with an expansive collection of sleek, go-everywhere style. From guest and lounge to task and stool, Axys delivers design versatility and commercial durability—all in a delightfully comfortable package.



Guest
Featured with SitOnIt Seating's Huntington – Night

EFFECTIVE FEBRUARY 23, 2026

Featured Models

GUEST :: \$788

Upholstered guest chair, grade 1 fabric

BAR STOOL :: \$976

Upholstered bar stool, grade 1 fabric



LOUNGE :: \$1,547

Upholstered lounge chair, grade 1 leather

Features

- Sculpted contouring paired with a perfectly padded seat for essential comfort
- Expertly crafted stitching, featuring double-needle and French seam border for added sophistication
- Expansive collection designed for versatile applications across any space
- Commercial-grade durability built to handle the demands of daily use
- Three distinctive shells available across five versatile models: guest, lounge, light task, bar stool, and counter stool
- Slim, modern lowback design elevates the style of bar and counter stools
- Steel wire rod frame with eye-catching X-pattern offered in charcoal and chrome finishes
- Optional glides available on wire rod frames
- 350 lb weight capacity warranty
- Complements Axys light task; see [page 62](#)

1. Product

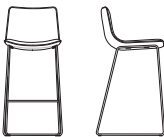
Product Type	Code	Price	
Guest	2101 S0 FT2	\$788	
Lounge	2105 FT2	\$1,163	
Counter Stool	2101 S9	\$976	
Bar Stool	2101 S2	\$976	

GUEST, LOUNGE, BAR & COUNTER STOOL

2. Back and Seat

Back Style	Code	Price	
Upholstered	UB	+\$0	
Seat Style	Code	Price	
Upholstered	US	+\$0	

4. Arms

Packaging	Code	Price	
Armless	AR0	+\$0	

3. Base

Base Finish	Code	Price	
Charcoal	FC19	+\$0	
Chrome	FC15	+\$0	
Glides	Code	Price	
No Glides	GL0	+\$0	
Glides	GL9	+\$9	



Lounge
Featured with SitOnIt Seating's Rally — Saddle

5. Material

Seat and BackTextile	Code	Price		
		Guest	Lounge	Stools
Fabric/Vinyl Grade 1	FG1/VG1	+\$0	+\$0	+\$0
COM	COM	+\$36	+\$43	+\$36
Fabric/Vinyl Grade 2	FG2/VG2	+\$36	+\$43	+\$36
Fabric/Vinyl Grade 3	FG3/VG3	+\$74	+\$89	+\$74
Fabric/Vinyl Grade 4	FG4/VG4	+\$121	+\$145	+\$121
Fabric/Vinyl Grade 5	FG5/VG5	+\$174	+\$209	+\$174
Fabric/Vinyl Grade 6	FG6/VG6	+\$235	+\$282	+\$235
Fabric/Vinyl Grade 7	FG7/VG7	+\$296	+\$355	+\$296
Leather Grade 1	LG1	+\$320	+\$384	+\$320
COL	COL	+\$420	+\$504	+\$420
Leather Grade 2	LG2	+\$420	+\$504	+\$420
Leather Grade 3	LG3	+\$540	+\$648	+\$540

Please reference the [Textile Reference Guide](#) for pricing on fabric over grade 7.



Bar Stool

Featured with SitOnIt Seating's Malibu — Ruby

GUEST, LOUNGE, BAR & COUNTER STOOL

6. Packaging

Packaging	Code	Price
Fully Assembled in Carton	AC	+\$0
Assembled in Bag (Southern CA Only)	AB	+\$0

GUEST AND LOUNGE SPECIFICATIONS

	2101 S0 FT2 Guest	2105 FT2 Lounge
Dimensions		
Overall Width	17.75"	25"
Overall Depth	23"	26.5"
Overall Height	32.75"	27"
Seat Width	17.75"	27"
Seat Depth	19"	21.75"
Seat Height	18.25"	15.5"
Back Width	17"	24"
Back Height	17"	16"
Materials		
COM	1.5 yd	1.75 yd
COL	21 sq ft	27 sq ft
Weight and Capacity		
Weight	19 lb	22 lb
Weight Capacity Warranty	350 lb	350 lb

STOOL SPECIFICATIONS

	2101 S9 Counter Stool	2101 S2 Bar Stool
Dimensions		
Overall Width	18.5"	19.5"
Overall Depth	20"	22.25"
Overall Height	35"	41"
Seat Width	17.75"	17.75"
Seat Depth	17.25"	17.25"
Seat Height	24.5"	30.25"
Back Width	17"	17"
Back Height	17"	17"
Materials		
COM	1.25 yd	1.25 yd
COL	18 sq ft	18 sq ft
Weight and Capacity		
Weight	18.5 lb	20 lb
Weight Capacity Warranty	350 lb	350 lb

Baja

MULTIPURPOSE CHAIR AND BAR STOOL

Immerse in possibilities.

Let's come together. When you want to feel the room and fill the room, there's Baja. Its comfort, customization, features and function will stand out— all while blending in – and echo the vibe of any space with subtle sophistication. Discover what's possible when you're surrounded by cohesive design.



Good
Featured with a Navy shell

EFFECTIVE FEBRUARY 23, 2026

Featured Models

GOOD :: \$436

All plastic, 4-leg, armless, standard multi-surface glides

BETTER :: \$501

Plastic back and upholstered seat, 4-leg, armless, standard multi-surface glides, grade 1 textile



BEST :: \$624

Fully upholstered, 4-leg, fixed arms, standard multi-surface glides, grade 1 textile

Features

- Scale and sculpture offer a roomier, more comfortable sit
- Seamless design and broad collection create cohesion in any space
- Residential-inspired features and options, including standard and low-back stools
- Responsive, single-piece shell offers 18 degrees of backrest flex
- Bases include wire rod, wire rod stool and 4-leg with casters or glides
- Choose from 14 shell colors, three arm pad colors, two wire rod and three 4-leg finishes
- Stackable on the floor or on a cart for quick clean-up and easy storage
- 300 lb weight capacity warranty





1. Frame

Frame Type	Code	Price	
4-Leg	1171 FT1	\$436	
Wire Rod	1171 FT2	\$413	
30" Wire Rod Bar Stool	1171 FT2 S2	\$563	

Frame Finish	Code	Price	
4-Leg (FT1) Only			
Black	FC1	+ \$0	
Silver	FC2	+ \$0	
White	FC12	+ \$0	
Wire Rod (FT2) Only			
Black	FC1	+ \$0	
Chrome	FC15	+ \$0	

MULTIPURPOSE CHAIR AND BAR STOOL

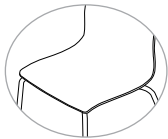
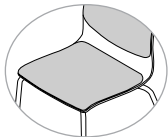
2. Back and Seat

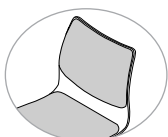

Back Size	Code	Price	
Standard Back	BK4	+ \$0	
Low Back	BK3	+ \$0	
Seat Style	Code	Price	
Plastic Seat	PS	+ \$0	
Upholstered Seat	US	+ \$65	
Back Style	Code	Price	
Plastic Back	PB	+ \$0	
Upholstered Back	UB	+ \$65	

Low back option available for bar stool (S2) only.

Upholstered back (UB) option available only with upholstered seat (US) and is not compatible with the low back (BK3) option.

Due to the nature of upholstery, stacking may cause impressions on the seat. SitOnIt Seating does not warrant the effects of stacking on upholstery.

3. Arms

Arm Style	Code	Price	
Armless	AR0	+ \$0	
Fixed Arms	AR1	+ \$58	

Fixed arms available on 4-leg chair (FT1) only. Arm finish matches frame finish. Arm pads are black on the black (FC1) frame or fog on the silver (FC2) and white on the white (FC12) frames.

4. Base

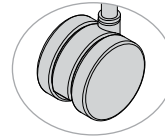
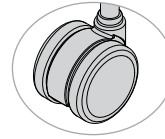
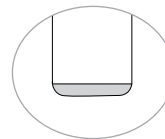
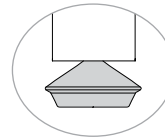
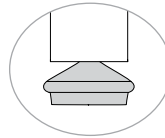
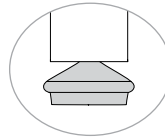
Casters or Glides	Code	Price	
Casters (For 4-Leg Chair FT1 Only)			
Carpet Casters	CS5	+ \$40	
Hard Floor and Carpet Casters	CS6	+ \$80	
Glides (For 4-Leg Chair FT1 Only)			
Standard Multi-Surface Glides	GL1	+ \$0	
Performance Multi-Surface Glides	GL2	+ \$20	
Floor Saver Glides	GL3	+ \$20	
Steel Glides (Carpet Only)	GL4	+ \$20	

MULTIPURPOSE CHAIR AND BAR STOOL

4. Base (Cont.)

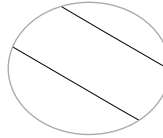
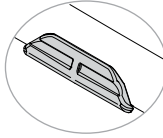
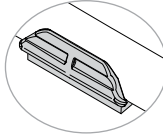

Casters or Glides	Code	Price	
Glides (For Wire Rod FT2 Only)			
No Glides	G0	+ \$0	
Clear Glides	CGR	+ \$9	
Clear Glides With Felt	CGRF	+ \$27	

Casters are black on the black (FC1) frame or fog on the silver (FC2) and white on the white (FC12) frames.



Best
Featured with an Arctic shell
and SitOnIt Seating's Dash — Cloud

5. Miscellaneous

Accessories	Code	Price	
Ganging Bracket	GG	+ \$30	
Stacking Cart	CART	+ \$399	

Ganging Brackets (GG) available on armless (AR0) models only.

Stacking Carts require assembly.

Please use caution when stacking models with casters to prevent frames damage. SitOnIt Seating does not warrant scratched frames.

See [page 127](#) for additional stacking requirements.



Better
Featured with a Sterling shell
and SitOnIt Seating's Dash — Navy

MULTIPURPOSE CHAIR AND BAR STOOL

6. Material

Shell Color	Code	Price	
Black	SC1	+ \$0	
Chocolate	SC4	+ \$0	
Latte	SC20	+ \$0	
Navy	SC5	+ \$0	
Slate	SC8	+ \$0	
Apple	SC24	+ \$0	
Arctic	SC21	+ \$0	
Bisque	SC7	+ \$0	
Lagoon	SC15	+ \$0	
Lemon	SC25	+ \$0	
Pacific	SC22	+ \$0	
Red	SC19	+ \$0	
Sterling	SC18	+ \$0	
Tangerine	SC23	+ \$0	

Textile	Code	Price	
Seat Only (US)			
Fabric/Vinyl Grade 1	FG1/VG1	+ \$0	
COM	COM	+ \$24	
Fabric/Vinyl Grade 2	FG2/VG2	+ \$24	
Fabric/Vinyl Grade 3	FG3/VG3	+ \$45	
Fabric/Vinyl Grade 4	FG4/VG4	+ \$77	
Fabric/Vinyl Grade 5	FG5/VG5	+ \$116	
Fabric/Vinyl Grade 6	FG6/VG6	+ \$159	
Fabric/Vinyl Grade 7	FG7/VG7	+ \$200	
Seat and Back (US + UB)			
Fabric/Vinyl Grade 1	FG1/VG1	+ \$0	
COM	COM	+ \$36	
Fabric/Vinyl Grade 2	FG2/VG2	+ \$36	
Fabric/Vinyl Grade 3	FG3/VG3	+ \$74	
Fabric/Vinyl Grade 4	FG4/VG4	+ \$121	
Fabric/Vinyl Grade 5	FG5/VG5	+ \$174	
Fabric/Vinyl Grade 6	FG6/VG6	+ \$235	
Fabric/Vinyl Grade 7	FG7/VG7	+ \$296	

Please reference the [Textile Reference Guide](#) for pricing on fabric over grade 7.

7. Packaging

Packaging	Code	Price	
Fully Assembled In a Carton	AC	+ \$0	
Fully Assembled In a Carton, Individually Packaged	AC1	+ \$20	

CHAIR SPECIFICATIONS

Model:	1171 FT1 4-Leg Chair	1171 FT2 Wire Rod Chair
Dimensions		
Overall Width With Arms	27"	N/A
Overall Width Armless	22.25"	22"
Overall Depth	21.5"	22.5"
Overall Height	32.5"	32"
Seat Width	18.5"	18.5"
Seat Depth	18"	18"
Seat Height	18"	17.5"
Back Width	18.25"	18.25"
Back Height	15.75"	16.5"
Materials		
COM	0.75 yd (US) 1 yd (UB)	0.75 yd (US) 1 yd (UB)
Stacking		
Max Cart Stacking Armless	10 (PS) 8 (US/UB)	6 (PS) 4 (US/UB)
Max Cart Stacking With Arms	10 (PS) 8 (US/UB)	N/A
Max Floor Stacking Armless	6 (PS) 4 (US/UB)	6
Max Floor Stacking With Arms	6 (PS) 4 (US/UB)	N/A
Weight and Capacity		
Weight With Arms	18 lb	N/A
Weight Armless	16 lb	15 lb
Weight Capacity Warranty	300 lb	300 lb

Plastic seat (PS). Upholstered seat (US). Upholstered back (UB).

MULTIPURPOSE CHAIR AND BAR STOOL

STOOL SPECIFICATIONS

Model:	1171 FT2 S2 30" Wire Rod Bar Stool
Dimensions	
Overall Width Armless	22"
Overall Depth	22.5"
Overall Height	45" (BK4) 35.25" (BK3)
Seat Width	18.5"
Seat Depth	18"
Seat Height	29.5"
Back Width	18.25"
Back Height	16.5" (BK4) 7" (BK3)
Materials	
COM	0.75 yd (US) 1 yd (UB)
Stacking	
Floor Stacking	4
Weight and Capacity	
Weight Armless	22 lb (BK4) 20 lb (BK3)
Weight Capacity	300 lb

Upholstered seat (US). Upholstered back (UB). Standard back (BK4). Low back (BK3).

Clova

GUEST CHAIR

Cozy up to collaboration.

Surround yourself with style and the enveloping comfort of Clova. This award-winning collection brings residential-inspired charm to modern workspaces, so you'll always feel right at home.

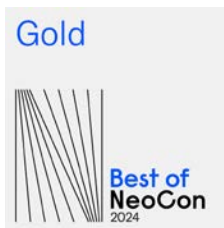

Better
Featured with Momentum's Feltro — Azure

EFFECTIVE FEBRUARY 23, 2026

Featured Models

GOOD :: \$1,773

Charcoal base finish, fully upholstered, grade 1 fabric

BETTER :: \$2,033

Polished aluminum finish, fully upholstered, grade 4 fabric

BEST :: \$2,165

Polished aluminum base, multi-upholstery, grade 3 vinyl seat and grade 4 vinyl back

Features

- Best of NeoCon Gold award winner from Claudio Bellini
- Residential-inspired collection with commercial durability
- Tailored stitching and sculpted silhouette on a two-piece design
- Multi-upholstery options available from thousands of textiles
- Two metal finish options
- 4-leg wood, 4-star metal and light task base options
- 350 lb weight capacity warranty
- Complements Clova light task chair and stool; see [page 65](#)



Good
Featured with SitOnIt Seating's Venice — Milestone

GUEST CHAIR

1. Product

Product Type	Code	Price	
Guest (4-Star Base)	2050	\$1,773	

2. Base

Cylinder	Code	Price	
Non-Swivel, Fixed-Height	CH7	+ \$0	
Auto-Return, Fixed-Height	CH6	+ \$25	
Base Material	Code	Price	
Metal	BMM	+ \$0	
Base Finish	Code	Price	
Charcoal	BF04	+ \$0	
Polished Aluminum	BF07	+ \$130	
Glides	Code	Price	
Standard Multi-Surface Glide	GL1	+ \$0	

3. Material

Moisture Barrier	Code	Price	
None	UM0	+\$0	
Seat Only	UM2	+\$59	
Fully Upholstered	Code	Price	
Fabric/Vinyl Grade 1	FG1/VG1	+ \$0	
COM	COM	+ \$58	
Fabric/Vinyl Grade 2	FG2/VG2	+ \$58	
Fabric/Vinyl Grade 3	FG3/VG3	+ \$91	
Fabric/Vinyl Grade 4	FG4/VG4	+ \$130	
Fabric/Vinyl Grade 5	FG5/VG5	+ \$195	
Fabric/Vinyl Grade 6	FG6/VG6	+ \$260	
Fabric/Vinyl Grade 7	FG7/VG7	+ \$325	
Leather Grade 1	LG1	+ \$465	
COL	COL	+ \$589	
Leather Grade 2	LG2	+ \$589	
Leather Grade 3	LG3	+ \$744	

3. Material

Multi-Upholstery	Code	Price
Multi-Upholstery Upcharge	UMU	+ \$113
Seat Textile Only		
Fabric/Vinyl Grade 1	FG1/VG1	+ \$0
COM	COM	+ \$44
Fabric/Vinyl Grade 2	FG2/VG2	+ \$44
Fabric/Vinyl Grade 3	FG3/VG3	+ \$68
Fabric/Vinyl Grade 4	FG4/VG4	+ \$97
Fabric/Vinyl Grade 5	FG5/VG5	+ \$146
Fabric/Vinyl Grade 6	FG6/VG6	+ \$195
Fabric/Vinyl Grade 7	FG7/VG7	+ \$244
Leather Grade 1	LG1	+ \$405
COL	COL	+ \$513
Leather Grade 2	LG2	+ \$513
Leather Grade 3	LG3	+ \$648
Back and Arms Textile Only		
Fabric/Vinyl Grade 1	FG1/VG1	+ \$0
COM	COM	+ \$37
Fabric/Vinyl Grade 2	FG2/VG2	+ \$37
Fabric/Vinyl Grade 3	FG3/VG3	+ \$57
Fabric/Vinyl Grade 4	FG4/VG4	+ \$81
Fabric/Vinyl Grade 5	FG5/VG5	+ \$122
Fabric/Vinyl Grade 6	FG6/VG6	+ \$162
Fabric/Vinyl Grade 7	FG7/VG7	+ \$203
Leather Grade 1	LG1	+ \$255
COL	COL	+ \$323
Leather Grade 2	LG2	+ \$323
Leather Grade 3	LG3	+ \$408

If different fabrics are selected for the seat and back, add the multi-upholstery upcharge as well, even if the fabrics are the same grade.

Please reference the [Textile Reference Guide](#) for pricing on fabric over grade 7.

5. Packaging

Packaging	Code	Price
Fully Assembled in Carton	P1	+ \$0
Assembled in Bag (SoCal Only)	P2	+ \$0

GUEST CHAIR

SPECIFICATIONS

	2050 Guest Chair
Dimensions	
Overall Width	26"
Overall Depth	23"
Overall Height	32"
Seat Width	21.5"
Seat Depth	18"
Seat Height	18.5"
Back Width	16"
Back Height	16"
Materials	
COM (Fully Upholstered)	2.25 yd
COM (Multi-Upholstery)	
Seat Only	1.75 yd
Back Only	1.25 yd
COL (Fully Upholstered)	40 sq ft
COL (Multi-Upholstery)	
Seat Only	32 sq ft
Back Only	20 sq ft
Weight and Capacity	
Weight	29 lb
Weight Capacity Warranty	350 lb



Best

Featured with a Mayer's Key Largo — Palm back and SitOnIt Seating's Affinity — Frost

Clova

SIDE CHAIR

Cozy up to collaboration.

Surround yourself with style and the enveloping comfort of Clova. This award-winning collection brings residential-inspired charm to modern workspaces, so you'll always feel right at home.

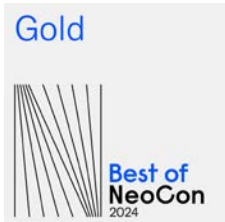

Best
Featured with Green Hides's Sierra — Muscat
and a Manitoba Wood Finish

EFFECTIVE FEBRUARY 23, 2026

Featured Models

GOOD :: \$1,773

4-leg wood base, fully upholstered,
grade 1 fabric

BETTER :: \$2,011

4-leg wood base, multi-upholstery,
grade 2 vinyl seat, grade 4 fabric back

BEST :: \$2,362

4-leg wood base, fully upholstered,
grade 2 leather

Features

- Best of NeoCon Gold award winner from Claudio Bellini
- Residential-inspired collection with commercial durability
- Tailored stitching and sculpted silhouette on a two-piece design
- Multi-upholstery options available from thousands of textiles
- 4 wood finish options
- 4-leg wood, 4-star metal and light task base options
- 350 lb weight capacity warranty
- Complements Clova light task chair and stool; see [page 65](#)

1. Product

Product Type	Code	Price	
Side (4-Leg Base)	2051	\$1,773	

2. Base

Base Material	Code	Price	
Wood	BMW	+ \$0	
Base Finish	Code	Price	
Neo	BF14	+ \$0	
Manitoba	BF15	+ \$0	
Colombian	BF09	+ \$0	
Skyline	BF10	+ \$0	
Stain-to-Match	STM	+ \$70	
Glides	Code	Price	
Standard Multi-Surface Glide	GL1	+ \$0	

One-time set-up fee of \$275 applies in addition to the \$70 stain-to-match (STM) cost.

SIDE CHAIR

3. Material

Moisture Barrier	Code	Price	
None	UM0	+ \$0	
Seat Only	UM2	+ \$59	
Fully Upholstered	Code	Price	
Fabric/Vinyl Grade 1	FG1/VG1	+ \$0	
COM	COM	+ \$58	
Fabric/Vinyl Grade 2	FG2/VG2	+ \$58	
Fabric/Vinyl Grade 3	FG3/VG3	+ \$91	
Fabric/Vinyl Grade 4	FG4/VG4	+ \$130	
Fabric/Vinyl Grade 5	FG5/VG5	+ \$195	
Fabric/Vinyl Grade 6	FG6/VG6	+ \$260	
Fabric/Vinyl Grade 7	FG7/VG7	+ \$325	
Leather Grade 1	LG1	+ \$465	
COL	COL	+ \$589	
Leather Grade 2	LG2	+ \$589	
Leather Grade 3	LG3	+ \$744	
Multi-Upholstery	Code	Price	
Multi-Upholstery Upcharge	UMU	+ \$113	
Seat Textile Only			
Fabric/Vinyl Grade 1	FG1/VG1	+ \$0	
COM	COM	+ \$44	
Fabric/Vinyl Grade 2	FG2/VG2	+ \$44	
Fabric/Vinyl Grade 3	FG3/VG3	+ \$68	
Fabric/Vinyl Grade 4	FG4/VG4	+ \$97	
Fabric/Vinyl Grade 5	FG5/VG5	+ \$146	
Fabric/Vinyl Grade 6	FG6/VG6	+ \$195	
Fabric/Vinyl Grade 7	FG7/VG7	+ \$244	
Leather Grade 1	LG1	+ \$405	
COL	COL	+ \$513	
Leather Grade 2	LG2	+ \$513	
Leather Grade 3	LG3	+ \$648	

3. Material

Multi-Upholstery	Code	Price
Back and Arms Textile Only		
Fabric/Vinyl Grade 1	FG1/VG1	+ \$0
COM	COM	+ \$37
Fabric/Vinyl Grade 2	FG2/VG2	+ \$37
Fabric/Vinyl Grade 3	FG3/VG3	+ \$57
Fabric/Vinyl Grade 4	FG4/VG4	+ \$81
Fabric/Vinyl Grade 5	FG5/VG5	+ \$122
Fabric/Vinyl Grade 6	FG6/VG6	+ \$162
Fabric/Vinyl Grade 7	FG7/VG7	+ \$203
Leather Grade 1	LG1	+ \$255
COL	COL	+ \$323
Leather Grade 2	LG2	+ \$323
Leather Grade 3	LG3	+ \$408

If different fabrics are selected for the seat and back, add the multi-upholstery upcharge as well, even if the fabrics are the same grade.

Please reference the [Textile Reference Guide](#) for pricing on fabric over grade 7.



Better
 Featured with SitOnIt Seating's Element — Chalk,
 Mayer's Key Largo — Jonquil and a Neo Finish wood base

SIDE CHAIR

4. Packaging

Packaging	Code	Price
Fully Assembled in Carton	P1	+ \$0
Assembled in Bag (Southern CA Only)	P2	+ \$0

SPECIFICATIONS

2051 Side Chair	
Dimensions	
Overall Width	26"
Overall Depth	23"
Overall Height	31.5"
Seat Width	21.5"
Seat Depth	18"
Seat Height	18.5"
Back Width	16"
Back Height	16"
Materials	
COM (Fully Upholstered)	2.25 yd
COM (Multi-Upholstery)	
Seat Only	1.75 yd
Back Only	1.25 yd
COL (Fully Upholstered)	40 sq ft
COL (Multi-Upholstery)	
Seat Only	32 sq ft
Back Only	20 sq ft
Weight and Capacity	
Weight	35 lb
Weight Capacity Warranty	350 lb

Cora

MULTIPURPOSE CHAIR, BARIATRIC,
COUNTER STOOL AND BAR STOOL

Ability for any facility.

With expert insights from Certified Healthcare Interior Designers® (CHID), Cora was designed to withstand the high demands of our modern spaces. It's a research-driven solution engineered for cleanability, reliability and durability—while ensuring central comfort and cohesion across every model.



*Best
Featured with SitOnIt Seating's
Spice — Electric Blue*

EFFECTIVE FEBRUARY 23, 2026

Featured Models

GUEST :: \$512

Guest chair, upholstered back, upholstered seat, fixed arms, standard multi-surface glides, grade 1 textile

MIDSIZE :: \$662

Midsized chair, upholstered back, upholstered seat, fixed arms, performance multi-surface glides, grade 1 textile

BARIATRIC :: \$915

Bariatric chair, upholstered back, upholstered seat, fixed arms, performance multi-surface glides, grade 1 textile

MULTIPURPOSE CHAIR, BARIATRIC, COUNTER STOOL AND BAR STOOL

Features

- Designed with expert insight from Certified Healthcare Interior Designers®
- A high-performing solution for any industry, including corporate, healthcare, education and more
- Easy to maintain with clean-out space and field replaceable components, including seat and back
- Wall-saver frame keeps everything fresh, preventing scuffs and marks
- Looped arms are streamlined yet wide enough to sit down and get up with ease
- Bleach cleanable, multi-upholstery and ballistic nylon options
- Edge-to-edge underseat cover provides full coverage on the guest model for enhanced stacking (four on floor; six on cart)
- Meets Healthier Hospitals Safer Chemicals Challenge 2.3, BIFMA LEVEL, GreenGuard Gold, and BIFMA X5.1 to X5.41
- Curated collection with an array of weight capacity warranties—guest model, easy access hip chair, counter stool and bar stool (500 lb), midsize model (600 lb), and bariatric model (750 lb)

1. Frame



Frame Type	Code	Price	
Guest (500 lb Capacity)	1191 SW19	\$512	
Midsize (600 lb Capacity)	1191 SW26	\$662	
Bariatric (700 lb Capacity)	1191 SW30	\$915	
Counter Stool (500 lb Capacity)	1191 SW19 S9	\$662	
Bar Stool (500 lb Capacity)	1191 SW19 S2	\$662	
Easy Access Hip Chair (500 lb Capacity)	1191 SW19 S4	\$827	
Frame Finish	Code	Price	
Black	FC1	+ \$0	
Silver	FC2	+ \$0	

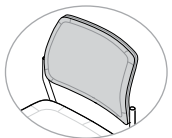
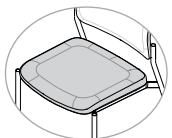

See the Super Duty Guide on page 85 for additional high weight capacity models.

2. Back and Seat

Back Style	Code	Price	
Upholstered Back	UB	+ \$0	
Seat Style	Code	Price	
Upholstered Seat	US	+ \$0	

3. Arms

Arm Style	Code	Price	
Armless	AR0	- \$49	
Fixed	AR1	+ \$0	

Arm Cap Finish	Code	Price	
Black	AC3	+ \$0	
Fog	AC6	+ \$0	

Armless (AR0) option is available on guest (SW19) chairs, counter (SW19 S9) and bar (SW19 S2) stools only.



*Bariatric
Featured with SitOnIt Seating's
Huntington — Night*

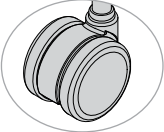
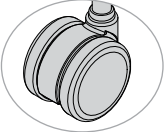
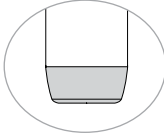
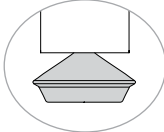
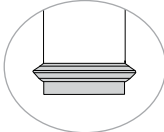
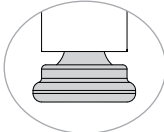
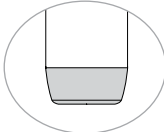
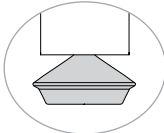
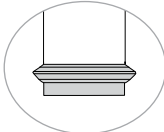
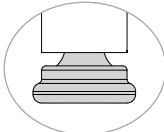

MULTIPURPOSE CHAIR, BARIATRIC, COUNTER STOOL AND BAR STOOL

4. Base

Casters or Glides	Code	Price	
Casters			
Carpet Casters	CS5	+ \$40	
Hard Floor and Carpet Casters	CS6	+ \$80	
Glides for Guest Chair, Hip Chair and Stools			
Standard Multi-Surface Glides	GL1	+ \$0	
Performance Multi-Surface Glides	GL2	+ \$17	
Floor Saver Glides	GL3	+ \$17	
Steel Glides (Carpet Only)	GL4	+ \$17	
Glides for Midsize or Bariatric Chair			
Standard Multi-Surface Glides	GL1	+ \$0	
Performance Multi-Surface Glides	GL2	+ \$0	
Floor Saver Glides	GL3	+ \$17	
Steel Glides (Carpet Only)	GL4	+ \$17	

Performance multi-surface glides (GL2) are standard on midsize (SW26) or bariatric (SW30) chairs. Caster color coordinates with frame color. Casters are available on guest (SW19) models only.

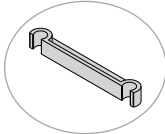
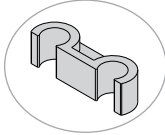
5. Miscellaneous

Accessories	Code	Price	
Ganging Bracket (Fixed Arms Only)	GA	+ \$30	
Ganging Bracket (Armless Only)	GG	+ \$30	
Stacking Cart	CART	+ \$399	

Stacking cart is only compatible with guest (SW19) models and is not compatible with casters (CS5/CS6). See page 127 for additional stacking requirements.

6. Material

Cleaning	Code	Price	
Moisture Barrier		Guest	Midsize/ Bariatric
Seat Only	UM2	+ \$35	+ \$35
Ballistic Nylon	Code	Price	
Ballistic Nylon Back	BN	+ \$0	+ \$0
Fully Upholstered	Code	Price	
Seat and Back Upholstery		Guest/Hip Chair/Stools	Midsize/ Bariatric
Fabric/Vinyl Grade 1	FG1/VG1	+ \$0	+ \$0
COM	COM	+ \$36	+ \$40
Fabric/Vinyl Grade 2	FG2/VG2	+ \$36	+ \$40
Fabric/Vinyl Grade 3	FG3/VG3	+ \$74	+ \$84
Fabric/Vinyl Grade 4	FG4/VG4	+ \$121	+ \$156
Fabric/Vinyl Grade 5	FG5/VG5	+ \$174	+ \$228
Fabric/Vinyl Grade 6	FG6/VG6	+ \$235	+ \$304
Fabric/Vinyl Grade 7	FG7/VG7	+ \$296	+ \$378
Leather Grade 1	LG1	+ \$140	+ \$240
COL	COL	+ \$200	+ \$540
Leather Grade 2	LG2	+ \$200	+ \$540
Leather Grade 3	LG3	+ \$280	+ \$820

MULTIPURPOSE CHAIR, BARIATRIC,
COUNTER STOOL AND BAR STOOL

6. Material (Cont.)

Multi-Upholstery	Code	Price	
Upcharge		Guest/Hip Chair/Stools	Midsize/ Bariatric
Multi-Upholstery Upcharge	UMU	+ \$58	+ \$58
Seat Upholstery Only		Guest/Hip Chair/Stools	Midsize/ Bariatric
Fabric/Vinyl Grade 1	FG1/VG1	+ \$0	+ \$0
COM	COM	+ \$24	+ \$26
Fabric/Vinyl Grade 2	FG2/VG2	+ \$24	+ \$26
Fabric/Vinyl Grade 3	FG3/VG3	+ \$45	+ \$60
Fabric/Vinyl Grade 4	FG4/VG4	+ \$77	+ \$116
Fabric/Vinyl Grade 5	FG5/VG5	+ \$116	+ \$172
Fabric/Vinyl Grade 6	FG6/VG6	+ \$159	+ \$213
Fabric/Vinyl Grade 7	FG7/VG7	+ \$200	+ \$254
Leather Grade 1	LG1	+ \$100	+ \$160
COL	COL	+ \$145	+ \$360
Leather Grade 2	LG2	+ \$145	+ \$360
Leather Grade 3	LG3	+ \$200	+ \$550

Ballistic nylon back (NBN) is not available with multi-upholstery (UMU).

Back Upholstery Only		Guest/Hip Chair/Stools	Midsize/ Bariatric
Fabric/Vinyl Grade 1	FG1/VG1	+ \$0	+ \$0
COM	COM	+ \$18	+ \$22
Fabric/Vinyl Grade 2	FG2/VG2	+ \$18	+ \$22
Fabric/Vinyl Grade 3	FG3/VG3	+ \$39	+ \$45
Fabric/Vinyl Grade 4	FG4/VG4	+ \$63	+ \$77
Fabric/Vinyl Grade 5	FG5/VG5	+ \$91	+ \$116
Fabric/Vinyl Grade 6	FG6/VG6	+ \$123	+ \$159
Fabric/Vinyl Grade 7	FG7/VG7	+ \$154	+ \$200
Leather Grade 1	LG1	+ \$70	+ \$130
COL	COL	+ \$100	+ \$295
Leather Grade 2	LG2	+ \$100	+ \$295
Leather Grade 3	LG3	+ \$140	+ \$450

If different fabrics are selected for the seat and back, add the multi-upholstery upcharge as well, even if the fabrics are the same grade.

Please reference the [Textile Reference Guide](#) for pricing on fabric over grade 7 and leather over grade 3. Additional CAL 133 information can be found on [page 12](#).

7. Packaging

Subhead	Code	Price	
Fully Assembled In a Carton	AC	+ \$0	

SPECIFICATIONS

Model: 1191	SW19 Guest Chair	SW26 Midsize Chair	SW30 Bariatric Chair
Dimensions			
Overall Width With Arms	24.75"	31.25"	35.5"
Overall Width Armless	21.25"	N/A	N/A
Overall Depth	23"	23"	23"
Overall Height	33.75"	33.75"	33.75"
Seat Width	18.75"	25.75"	29.5"
Seat Depth	17.5"	17.5"	17.5"
Seat Height	18.25"	18.25"	18.25"
Back Width	19"	27.5"	30"
Back Height	15.75"	15.75"	15.75"
Materials			
COM (Back)	0.75 yd	0.95 yd	1.25 yd
COM (Seat)	0.9 yd	1 yd	1.25 yd
COM (Seat and Back)	1.25 yd	1.75 yd	2 yd
COL (Back)	12 sq ft	15 sq ft	18 sq ft
COL (Seat)	14 sq ft	17 sq ft	21 sq ft
COL (Seat and Back)	21 sq ft	27 sq ft	30 sq ft
Stacking			
Max Cart Stacking	6	N/A	N/A
Max Floor Stacking	4	N/A	N/A
Weight and Capacity			
Weight With Arms	24.5 lb	37 lb	42.5 lb
Weight Armless	23 lb	N/A	N/A
Weight Capacity Warranty	500 lb	600 lb	750 lb

MULTIPURPOSE CHAIR, BARIATRIC, COUNTER STOOL AND BAR STOOL

SPECIFICATIONS

Model: 1191	SW19 S9 Counter Stool	SW19 S2 Bar Stool	SW19 S4 Easy Access Hip Chair
Dimensions			
Overall Width With Arms	24.75"	24.75"	24.75"
Overall Width Armless	21.25"	21.25"	N/A
Overall Depth	23"	23"	23.5"
Overall Height	39.5"	45.5"	39.5"
Seat Width	18.75"	18.75"	18.75"
Seat Depth	18.75"	18.75"	18.75"
Seat Height	24"	30"	24"
Back Width	19"	19"	19"
Back Height	15.75"	15.75"	15.75"
Materials			
COM (Back)	0.75 yd	0.75 yd	0.75 yd
COM (Seat)	0.9 yd	0.9 yd	0.9 yd
COM (Seat and Back)	1.25 yd	1.25 yd	1.25 yd
COL (Back)	12 sq ft	12 sq ft	12 sq ft
COL (Seat)	14 sq ft	14 sq ft	14 sq ft
COL (Seat and Back)	21 sq ft	21 sq ft	21 sq ft
Stacking			
Max Cart Stacking	N/A	N/A	N/A
Max Floor Stacking	N/A	N/A	N/A
Weight and Capacity			
Weight With Arms	35 lb	36 lb	38 lb
Weight Armless	33.5 lb	34.5 lb	N/A
Weight Capacity Warranty	500 lb	500 lb	500 lb



EFFECTIVE
FEBRUARY 23, 2026

REPLACEMENT SEATING PARTS

Replacement Parts: Seats

Seat Size	Code	Price	
Guest/Hip Chair/Counter Stool/Bar Stool Seat	SEAT	\$70	
Midback Seat	SEAT	\$85	
Bariatric Seat	SEAT	\$125	
Multi-Upholstery	Code	Price	
Seat Upholstery Only		Guest/Hip Chair/Stools	Midsize/Bariatric
Fabric/Vinyl Grade 1	FG1/VG1	+ \$0	+ \$0
COM	COM	+ \$24	+ \$28
Fabric/Vinyl Grade 2	FG2/VG2	+ \$24	+ \$28
Fabric/Vinyl Grade 3	FG3/VG3	+ \$45	+ \$60
Fabric/Vinyl Grade 4	FG4/VG4	+ \$77	+ \$116
Fabric/Vinyl Grade 5	FG5/VG5	+ \$116	+ \$172
Fabric/Vinyl Grade 6	FG6/VG6	+ \$159	+ \$213
Fabric/Vinyl Grade 7	FG7/VG7	+ \$200	+ \$254
Leather Grade 1	LG1	+ \$100	+ \$160
COL	COL	+ \$145	+ \$360
Leather Grade 2	LG2	+ \$145	+ \$360
Leather Grade 3	LG3	+ \$200	+ \$550

Replacement Parts: Back

Seat Size	Code	Price	
Guest Back	BACK	\$95	
Midback Back	BACK	\$125	
Bariatric Back	BACK	\$165	
Multi-Upholstery	Code	Price	
Back Upholstery Only		Guest/Hip Chair/Stools	Midsize/Bariatric
Fabric/Vinyl Grade 1	FG1/VG1	+ \$0	+ \$0
COM	COM	+ \$20	+ \$24
Fabric/Vinyl Grade 2	FG2/VG2	+ \$20	+ \$24
Fabric/Vinyl Grade 3	FG3/VG3	+ \$39	+ \$45
Fabric/Vinyl Grade 4	FG4/VG4	+ \$63	+ \$77
Fabric/Vinyl Grade 5	FG5/VG5	+ \$91	+ \$116
Fabric/Vinyl Grade 6	FG6/VG6	+ \$123	+ \$159
Fabric/Vinyl Grade 7	FG7/VG7	+ \$154	+ \$200
Leather Grade 1	LG1	+ \$70	+ \$130
COL	COL	+ \$100	+ \$295
Leather Grade 2	LG2	+ \$100	+ \$295
Leather Grade 3	LG3	+ \$140	+ \$450

Flytech

STACKING NESTER CHAIR

Sit back. Nest forward.

As the only angled nester (that also stacks) out there, our innovative Flytech is truly a forward-leaning, space-saving solution. Chairs deploy easily and securely with a latch that locks the seat into position with a satisfying click. And the multiple mesh and upholstery options mean you can take flight anywhere.



Mesh Back
Featured with Lemon mesh and SitOnIt
Seating's Venice — Golddust

EFFECTIVE FEBRUARY 23, 2026

Featured Models

PLASTIC :: \$566

Plastic seat and back, armless, fog shell, black frame, carpet casters

MESH BACK :: \$654

Mesh back, upholstered seat, white shell, fog frame and base, fixed arms, carpet casters, grade 1 textile

UPHOLSTERED :: \$712

Upholstered back, upholstered seat, white shell, fog frame and base, fixed arms, carpet casters, grade 1 textile

Features

- Slim modern design fits any space—education, training, multipurpose and more
- Contoured seat and flexing back provide essential comfort
- Stacks up to four chairs and nests endlessly
- Handy latch securely locks the seat with a satisfying click
- Clean-out space and steel frame plus plastic shell and vinyl options make it ultra cleanable
- 12 breathable mesh colors; three plastic shell colors; two leg and arm colors
- 350 lb weight capacity warranty



Plastic Back
Featured with a Fog shell

STACKING NESTER CHAIR

1. Frame

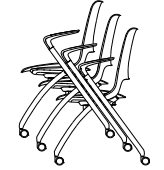
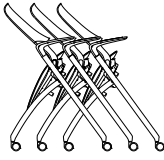
Frame Type	Code	Price	
Stacking/Nesting	1651 FT4	\$531	 

2. Seat

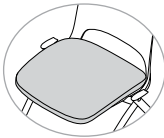

Seat Material	Code	Price	
Plastic Seat	PS	+ 0	
Upholstered Seat	US	+ \$58	

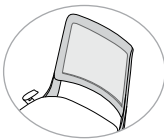
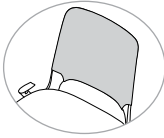
3. Back

Back Material	Code	Price	
Plastic Back	PB	+ 0	
Mesh Back	MB	+ \$33	
Upholstered Back	UB	+ \$58	

The upholstered back (UB) is only available with the upholstered seat (US).

4. Arms

Arm Style	Code	Price	
Armless	AR0	+ \$0	
Fixed Arms	AR1	+ \$30	

Arms (AR1) will match frame color.

5. Base

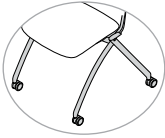
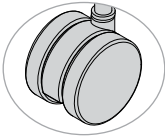
Frame and Caster Color	Code	Price	
Black	FC1	+ \$0	
Silver	FC2	+ \$0	
Caster Style	Code	Price	
Casters			
Carpet Casters	CS5	+ \$0	
Hard Floor and Carpet Casters	CS6	+ \$40	

6. Material

Shell Color	Code	Price	
Black	SC1	+ \$0	
Fog	SC27	+ \$35	
White	SC26	+ \$35	
Mesh Color (For MB Only)	Code	Price	
Apple	MC31	+ \$0	
Aqua	MC30	+ \$0	
Desert	MC22	+ \$0	
Electric Blue	MC24	+ \$0	
Fire	MC25	+ \$0	
Fog	MC23	+ \$0	
Grape	MC26	+ \$0	
Lemon	MC27	+ \$0	
Nickel	MC21	+ \$0	
Ocean	MC29	+ \$0	
Onyx	MC20	+ \$0	
Tangerine	MC28	+ \$0	

STACKING NESTER CHAIR

6. Material (Cont.)

Textile	Code	Price	
		Seat Only	Seat and Back
Fabric/Vinyl Grade 1	FG1/VG1	+ \$0	+ \$0
COM	COM	+ \$24	+ \$36
Fabric/Vinyl Grade 2	FG2/VG2	+ \$24	+ \$36
Fabric/Vinyl Grade 3	FG3/VG3	+ \$45	+ \$74
Fabric/Vinyl Grade 4	FG4/VG4	+ \$77	+ \$121
Fabric/Vinyl Grade 5	FG5/VG5	+ \$116	+ \$174
Fabric/Vinyl Grade 6	FG6/VG6	+ \$159	+ \$235
Fabric/Vinyl Grade 7	FG7/VG7	+ \$200	+ \$296

Stacking is not recommended when vinyl is specified.

Please reference the [Textile Reference Guide](#) for pricing on fabric over grade 7.

7. Packaging

Packaging	Code	Price	
Fully Assembled In a Carton	AC	+ \$0	
Assembled in Bag (Southern California Only)	AB	+ \$0	



EFFECTIVE FEBRUARY 23, 2026 | GSA SIN #: 33721

SPECIFICATIONS

Model:	1651 FT4 Stacker/Nester Chair
Dimensions	
Overall Width With Arms	23.75"
Overall Width Armless	23"
Overall Depth	23.85"
Overall Height	34.5"
Seat Width	18"
Seat Depth	16.75"
Seat Height	18"
Back Width	17.75"
Back Height	19.5"
Stacking	
Floor Stacking	3 (PS), 4 (US)
Materials	
COM	0.75 yd (US), 1.25 (US+UB)
Weight and Capacity	
Weight With Arms	20 lb
Weight Armless	19 lb
Weight Capacity Warranty	350 lb

Upholstered seat (US). Upholstered back (UB).

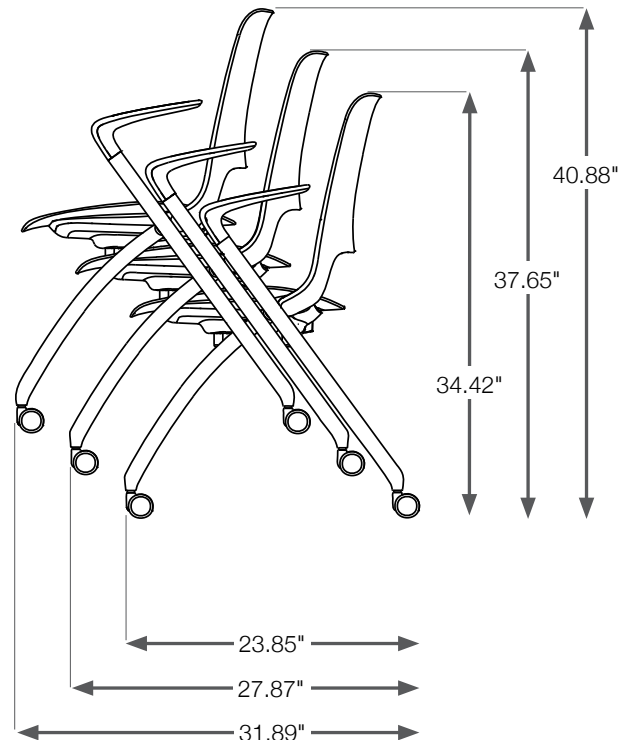
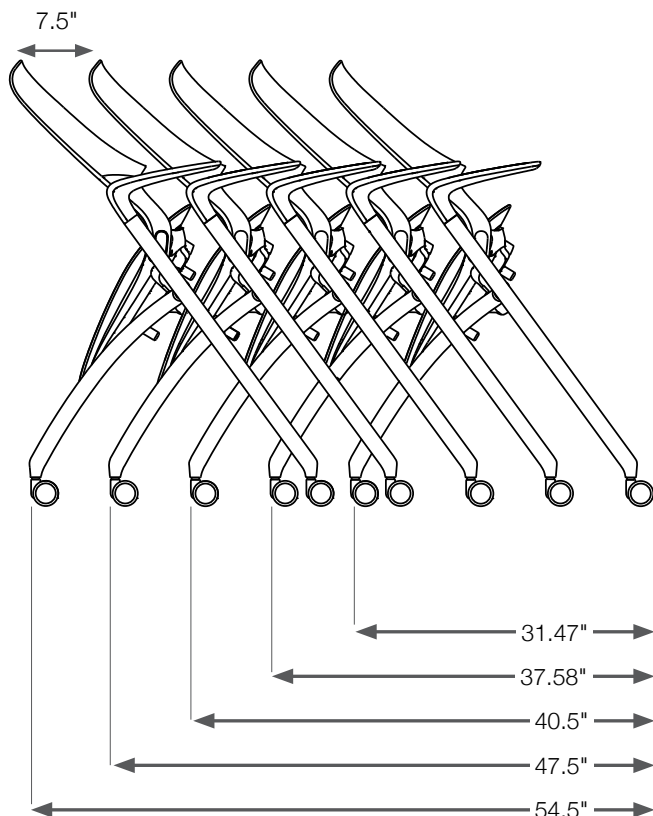

Focus Side

MULTIPURPOSE CHAIR, COUNTER STOOL AND BAR STOOL

Where comfort, style and ergonomics converge.

The revitalized Focus™ Side combines comfort and design for multi-purpose, office or reception areas. Choose either the 4-leg side chair, bar or counter stools in 3 back options – mesh, upholstered and wood. Two different frame finishes permit it to blend in—or stand out. Focus Side is part of a broad and versatile collection that includes executive and task models. Designed to complement Focus and Amplify task chairs.



Good
Featured with Black mesh
and SitOnIt Seating's Spice – Fire

EFFECTIVE FEBRUARY 23, 2026

Featured Models

GOOD :: \$579

Multipurpose chair, mesh back, upholstered seat, standard multi-surface glides, armless, grade 1 textile

BETTER :: \$628

Multipurpose chair, mesh back, upholstered seat, standard multi-surface glides, arms, grade 1 textile

BEST :: \$793

Multipurpose chair, clear maple slotted wood back, upholstered seat, arms, carpet casters, grade 1 textile

FOCUS SIDE

EFFECTIVE FEBRUARY 23, 2026 | GSA SIN #: 33721

Features









- 4-leg side chair, 30" bar and 24" counter stool models
- Three back options: mesh, wood and fully upholstered
- 15 bleach-cleanable mesh back colors
- Two wood back styles and four wood stain finishes
- Black or silver frame
- Upholstered waterfall seat
- Mesh back model stacks four on the floor, five on the optional cart; upholstered back model stacks three on the floor, three on the optional cart
- 300 lb weight capacity warranty
- Complements Focus and Focus 2.0 task chairs and stools; see [page 68](#) and [page 86](#)



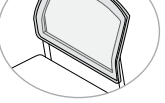

Better
Featured with Apple mesh
and SitOnIt Seating's Dash — Cloud

MULTIPURPOSE CHAIR, COUNTER STOOL AND BAR STOOL

1. Frame

Model and Frame Finish	Code	Price	
Chairs			
Black	5651	\$628	
Silver	5652	\$628	
Black With Black Carpet Casters	5641	\$668	
Silver With Black Carpet Casters	5642	\$668	
Stools			
24" Black Counter Stool	5651 S9	\$778	
24" Silver Counter Stool	5652 S9	\$778	
30" Black Bar Stool	5651 S2	\$778	
30" Silver Bar Stool	5652 S2	\$778	

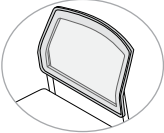
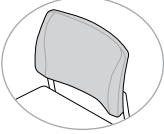

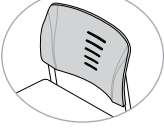
2. Back

Back Style	Code	Price	
Mesh	B1	+ \$0	
Upholstered	B3	+ \$58	
Solid Wood	WB1	+ \$125	
Slotted Wood	WB2	+ \$125	

FOCUS SIDE

EFFECTIVE FEBRUARY 23, 2026 | GSA SIN #: 33721

3. Arms

Arm Style	Code	Price	
Armless	A0	- \$49	
Fixed Loop	A130	+ \$0	

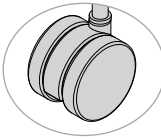
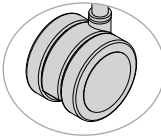
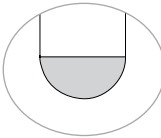
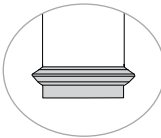
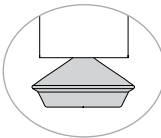
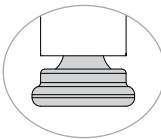

4. Base

Casters and Glides	Code	Price	
Casters			
Carpet Casters	C13	+ \$0	
Hard Floor and Carpet Casters	C12	+ \$40	
Casters and Glides			
Glides			
Standard Multi-Surface Glides	G5	+ \$0	
Floor Saver Glides	G12	+ \$17	
Performance Multi-Surface Glides	GL2	+ \$17	
Steel Glides (Carpet Only)	G13	+ \$17	

Please use caution when stacking models with casters to prevent frame damage. SitOnIt Seating does not warrant scratched frames. Casters are not available on counter stool (S9) or bar stool (S2).

MULTIPURPOSE CHAIR, COUNTER STOOL AND BAR STOOL

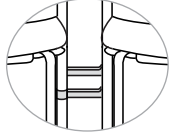
5. Miscellaneous

Accessories	Code	Price	
Ganging Bracket for Armless Models	GG11	+ \$30	
Ganging Bracket for Models With Arms	GA11	+ \$30	
Stacking Cart	56-Cart	+ \$399	

Ganging brackets and stacking carts are not intended for use with caster models or stools and are compatible with glides only. Wood back chairs (WB1/WB2) are not stackable. See page 127 for additional stacking requirements.



Best
Featured with a Clear Maple back and SitOnIt Seating's Sugar — Electric Blue

6. Material

Protection	Code	Price
Fire Retardancy		
CAL 133, Fabric, Quantities 1–49	133F	+ \$99
CAL 133, Fabric, Quantities 50+	133F5	+ \$55
CAL 133, Leather, Any Quantity	133L	+ \$119
Mesh Color (For B1)	Code	Price
Matches Amplify		
Apple	MC31	+ \$0
Aqua	MC30	+ \$0
Desert	MC9	+ \$0
Electric Blue	MC24	+ \$0
Fire	MC10	+ \$0
Fog	MC7	+ \$0
Navy	MC8	+ \$0
Nickel	MC6	+ \$0
Onyx	MC5	+ \$0
Tangerine	MC28	+ \$0
Matches Focus		
Black	MC1	+ \$0
Sand	MC3	+ \$0
Slate	MC2	+ \$0
Freeway Sport Stripe (Black/Slate)	MC33	+ \$0
Impress Sport Stripe (Slate/Black)	MC34	+ \$0
Wood Stain (For WB)	Code	Price
Amber Mahogany	S5	+ \$0
Clear Maple	S1	+ \$0
Espresso	S8	+ \$0
Medium Cherry	S3	+ \$0

Please reference the [Textile Reference Guide](#) for pricing on fabric over grade 7 and leather over grade 3. Additional CAL 133 information can be found on [page 12](#).

MULTIPURPOSE CHAIR, COUNTER STOOL AND BAR STOOL

6. Material (Cont.)

Textile	Code	Price
Seat Only (For B1/WB)		
Fabric/Vinyl Grade 1	FG1/VG1	+ \$0
COM	COM	+ \$24
Fabric/Vinyl Grade 2	FG2/VG2	+ \$24
Fabric/Vinyl Grade 3	FG3/VG3	+ \$45
Fabric/Vinyl Grade 4	FG4/VG4	+ \$77
Fabric/Vinyl Grade 5	FG5/VG5	+ \$116
Fabric/Vinyl Grade 6	FG6/VG6	+ \$159
Fabric/Vinyl Grade 7	FG7/VG7	+ \$200
Leather Grade 1	LG1	+ \$140
COL	COL	+ \$200
Leather Grade 2	LG2	+ \$200
Leather Grade 3	LG3	+ \$280
Seat and Back (For B3)		
Fabric/Vinyl Grade 1	FG1/VG1	+ \$0
COM	COM	+ \$36
Fabric/Vinyl Grade 2	FG2/VG2	+ \$36
Fabric/Vinyl Grade 3	FG3/VG3	+ \$74
Fabric/Vinyl Grade 4	FG4/VG4	+ \$121
Fabric/Vinyl Grade 5	FG5/VG5	+ \$174
Fabric/Vinyl Grade 6	FG6/VG6	+ \$235
Fabric/Vinyl Grade 7	FG7/VG7	+ \$296
Leather Grade 1	LG1	+ \$260
COL	COL	+ \$320
Leather Grade 2	LG2	+ \$320
Leather Grade 3	LG3	+ \$400

Please reference the [Textile Reference Guide](#) for pricing on fabric over grade 7 and leather over grade 3. Additional CAL 133 information can be found on [page 12](#).

Please reference the [Fabric information](#) found on [page 18](#) for pricing on multi-upholstery.

7. Packaging

Packaging	Code	Price
Fully Assembled In a Carton (Chairs)	AC3	+ \$0
Fully Assembled In a Carton, Individually Packed Chairs	AC1	+ \$20
Fully Assembled In a Carton, Individually Packed Stools	AC1	+ \$0

CHAIR SPECIFICATIONS

Model:	5651 / 5652 Side Chair	5641 / 5642 Side Chair with Casters
Dimensions		
Overall Width Armless	20.5"	20.5"
Overall Width With Arms	24.5"	24.5"
Overall Depth	26" (B1/WB) 25"(B3)	26" (B1/WB) 25" (B3)
Overall Height	34"(B1) 32.5" (B3/WB)	34" (B1) 32.5" (B3/WB)
Seat Width	18"	18"
Seat Depth	18.5"	18.5"
Seat Height	18"	18"
Back Width	20.5"	20.5"
Back Height	18"	18"
Materials		
COM	1 yd (B1/WB) 1.25 yd (B3)	1 yd (B1/WB) 1.25 yd (B3)
COL	12 sq ft (B1/WB) 20 sq ft (B3)	12 sq ft (B1/WB) 20 sq ft (B3)
Stacking		
Maximum Cart Stacking	5 (B1 Only) 3 (B3 Only)	5 (B1 Only) 3 (B3 Only)
Maximum Floor Stacking	4 (B1 Only) 3 (B3 Only)	4 (B1 Only) 3 (B3 Only)
Cart Stacking Weight Armless	133.5 lb	Not Recommended
Cart Stacking Weight With Arms	148.5 lb	Not Recommended
Floor Stacking Weight Armless	84 lb	Not Recommended
Floor Stacking Weight With Arms	96 lb	Not Recommended
Weight and Capacity		
Weight Armless	21 lb (B1/B3) 22 lb (WB)	21 lb (B1/B3) 22 lb (WB)
Weight With Arms	24 lb (B1/B3) 25 lb (WB)	24 lb (B1/B3) 25 lb (WB)
Weight Capacity Warranty	300 lb	300 lb

Mesh back (B1). Upholstered back (B3). Wood back (WB).

MULTIPURPOSE CHAIR, COUNTER STOOL AND BAR STOOL

STOOL SPECIFICATIONS

	5651 S9 / 5652 S9 24" Counter Stool	5652 S1 / 5652 S2 30" Bar Stool
Dimensions		
Overall Width Armless	20.5"	20.5"
Overall Width With Arms	24.5"	24.5"
Overall Depth	26" (B1/WB) 25" (B3)	26" (B1/WB) 25" (B3)
Overall Height	39.5" (B1) 37" (B3/WB)	46.5" (B1) 44" (B3/WB)
Seat Width	18"	18"
Seat Depth	18.5"	18.5"
Seat Height	24"	31"
Back Width	20.5"	20.5"
Back Height	18"	18"
Materials		
COM	1 yd (B1/WB) 1.25 yd (B3)	1 yd (B1/WB) 1.25 yd (B3)
COL	17 sq ft (B1/WB) 20 sq ft (B3)	17 sq ft (B1/WB) 20 sq ft (B3)
Weight and Capacity		
Weight Armless	28 lb (B1/B3) 29 lb (WB)	30 lb (B1/B3) 31 lb (WB)
Weight With Arms	31 lb (B1) 32 lb (B3/WB)	33 lb (B1) 34 lb (B3/WB)
Weight Capacity Warranty	300 lb	300 lb

Mesh back (B1). Upholstered back (B3). Wood back (WB).

Freelance

MULTIPURPOSE CHAIR, COUNTER STOOL AND BAR STOOL

Built for durability.

Imagine the versatility.

The transitional design of Freelance side chairs works well in lobby areas, workstations and offices. The comfortable, curved seat and structural integrity has made it a high-demand, multipurpose chair. Two frame/arm finish combinations create variety. Freelance is a broad collection of 4-leg chair, counter and bar stools.



Better
Featured with a Navy shell and
SitOnIt Seating's Huntington — Night

EFFECTIVE FEBRUARY 23, 2026

Featured Models

GOOD :: \$503

4-leg chair, all plastic seat and back, arms, standard multi-surface glides

BETTER :: \$561

4-leg chair, upholstered seat and plastic back, arms, standard multi-surface glides, grade 1 textile



BEST :: \$659

4-leg chair, upholstered seat and back, arms, carpet casters, grade 1 textile

Features

- Fully upholstered, upholstered seat or plastic
- Nine plastic colors
- Two frame/arm finish combinations: black and silver/slate.
- Waterfall seat
- Molded shroud underside
- Wall-saver frame design
- Stacks four on floor, six on the optional cart
- Weight capacity warranty:
300 lb for all plastic chairs and stools or upholstered chairs with casters;
400 lb for upholstered chairs with glides;
500 lb for Heavy Duty 24/7

1. Back

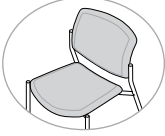
Back and Seat Style	Code	Price	
Plastic	No Code	\$503	
Upholstered Seat	US	\$561	
Upholstered Seat and Back	UP	\$619	

2. Super Duty

Heavy Duty Series	Code	Price	
Heavy Duty	HD	+ \$306	

Heavy Duty option only available on upholstered 4-leg chair frame (521) with glides. See the Super Duty Guide on [page 85](#) for additional high weight capacity models..

MULTIPURPOSE CHAIR, COUNTER STOOL AND BAR STOOL

3. Seat

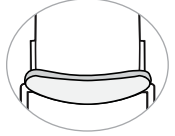
Seat Options	Code	Price	
1" Additional Foam	F1	+ \$36	

4. Frame

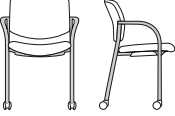
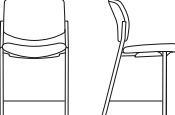
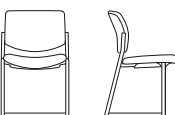



Frame Type	Code	Price	
Chairs			
4-Leg Chair	521X	+ \$0	
4-Leg Chair With Carpet Casters	522X	+ \$40	
Stools			
24" Counter Stool	5214 S9	+ \$150	
30" Bar Stool	5214 S2	+ \$150	
Frame Finish	Code	Price	
Black	FB	+ \$0	
Silver	FS	+ \$0	

Arm color will match the frame color unless otherwise specified. "x" = arm or armless; see arms section on the following page.

FREELANCE

EFFECTIVE FEBRUARY 23, 2026 | GSA SIN #: 33721

5. Arms

Arm Style	Code	Price	
For Chairs			
Armless (Append Arm Code to Frame Type Code)	XXX3	- \$49	
Fixed Loop Arms (Append Arm Code to Frame Type Code)	XXX4	+ \$0	
For Stools			
Armless	5213	- \$49	
Fixed Loop Arms	5214	+ \$0	

Arm Color	Code	Price	
Black	AC3	+ \$0	
Slate	AC4	+ \$0	

Arm color will match the frame color unless specified otherwise.

6. Base

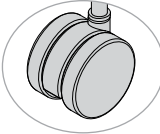
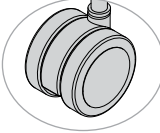
Casters or Glides	Code	Price	
Casters			
Carpet Casters	C13	+ \$0	
Hard Floor and Carpet Casters	C12	+ \$40	

Casters are not available on stool models.

MULTIPURPOSE CHAIR, COUNTER STOOL AND BAR STOOL

6. Base (Cont.)

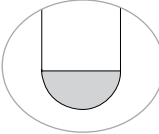
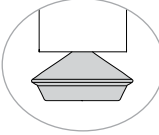
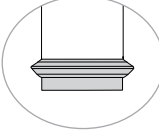
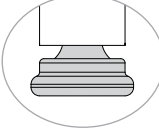
Arm Color	Code	Price	
Glides for 4-Leg Chair (521X/522X) and Stool (S2/S9)			
Standard Multi-Surface Glides	G5	+ \$0	
Performance Multi-Surface Glides	GL2	+ \$17	
Performance Multi-Surface Glides for Heavy Duty Option Only	GL2	+ \$0	
Floor Saver Glides	G12	+ \$17	
Steel Glides (Carpet Only)	G13	+ \$17	

Glides (GL2) are standard for Heavy Duty (HD) option.

Please use caution when stacking models with casters to prevent frame damage. SitOnIt Seating does not warrant scratched frames.



Good
Featured with a Lagoon shell

7. Miscellaneous

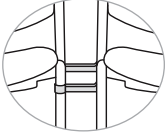
Accessories	Code	Price	
Stacking Cart	14-Cart	+ \$399	
Ganging Bracket for Armless Models	GG2	+ \$30	
Ganging Bracket for Models With Arms	GA2	+ \$30	

Accessories are not compatible with stool models (S2/S9).

See [page 127](#) for additional stacking requirements.

Please use caution when stacking models with casters to prevent frame damage. SitOnIt Seating does not warrant scratched frames.

8. Material

Protection	Code	Price	
Fire Retardancy			
CAL 133, Fabric, Quantities 1–49	133F	+ \$99	
CAL 133, Fabric, Quantities 50+	133F5	+ \$55	
CAL 133, Plastic, Any Quantity	133P	+ \$45	
Ballistic Nylon Back			
Ballistic Nylon Back	BN	+ \$0	
Shell Color			
Arctic	SC21	+ \$0	
Black	SC1	+ \$0	
Chocolate	SC4	+ \$0	
Lagoon	SC15	+ \$0	
Latte	SC20	+ \$0	
Navy	SC5	+ \$0	
Red	SC19	+ \$0	
Slate	SC8	+ \$0	
Sterling	SC18	+ \$0	

MULTIPURPOSE CHAIR, COUNTER STOOL AND BAR STOOL

8. Material (Cont.)

Textile	Code	Price	
Seat Only (For US)			
Fabric/Vinyl Grade 1	FG1/VG1	+ \$0	
COM	COM	+ \$24	
Fabric/Vinyl Grade 2	FG2/VG2	+ \$24	
Fabric/Vinyl Grade 3	FG3/VG3	+ \$45	
Fabric/Vinyl Grade 4	FG4/VG4	+ \$77	
Fabric/Vinyl Grade 5	FG5/VG5	+ \$116	
Fabric/Vinyl Grade 6	FG6/VG6	+ \$159	
Fabric/Vinyl Grade 7	FG7/VG7	+ \$200	
Seat and Back (UP)			
Fabric/Vinyl Grade 1	FG1/VG1	+ \$0	
COM	COM	+ \$36	
Fabric/Vinyl Grade 2	FG2/VG2	+ \$36	
Fabric/Vinyl Grade 3	FG3/VG3	+ \$74	
Fabric/Vinyl Grade 4	FG4/VG4	+ \$121	
Fabric/Vinyl Grade 5	FG5/VG5	+ \$174	
Fabric/Vinyl Grade 6	FG6/VG6	+ \$235	
Fabric/Vinyl Grade 7	FG7/VG7	+ \$296	
Leather/Ballistic Grade 1	LG1/BN1	+ \$140	
COL	COL	+ \$249	
Leather/Ballistic Grade 2	LG2/BN2	+ \$249	
Leather/Ballistic Grade 3	LG3/BN3	+ \$321	

Please reference the [Textile Reference Guide](#) for pricing on fabric over grade 7 and leather over grade 3. Additional CAL 133 information can be found on [page 12](#).

Please reference the Fabric information found on [page 18](#) for pricing on multi-upholstery.

9. Packaging

Packaging	Code	Price	
Fully Assembled Stools in a Carton	AC	+ \$0	
4-Leg Models			
Fully Assembled In a Carton, When 3 Are Ordered	3C	+ \$0	
Fully Assembled in a Carton, When 2 Are Ordered	2C	+ \$10	
Fully Assembled In a Carton, Individually Packaged	AC1	+ \$20	

MULTIPURPOSE CHAIR, COUNTER STOOL AND BAR STOOL

CHAIR SPECIFICATIONS

Model:	5213 / 5214 / 5223 / 5224 4-Leg Chair
Dimensions	
Overall Width Armless	21.5"
Overall Width With Arms	25"
Overall Depth	24"
Overall Height	33.25"
Seat Width	19.5"
Seat Depth	18.5"
Seat Height	17.5"
Back Width	19.5"
Back Height	16"
Materials	
COM	.99 yd (US) .99 yd (US) (BN) 1.25 yd (UP) 1.15 yd (UP) (BN)
COL	15 sq ft (US) 15 sq ft (US) (BN) 25 sq ft (UP) 21 sq ft (UP) (BN)
Stacking	
Max Cart Stacking	6
Max Floor Stacking	4
Weight and Capacity	
Weight Armless	26.5 lb
Weight With Arms	28.5 lb
Weight Armless (3 Pack)	80 lb
Weight With Arms (3 Pack)	86 lb
Weight Capacity Warranty	300 lb (Plastic/US)(UP C12/C13) 400 lb (UP G5/GL2/G12/G13) 500 lb (HD)

Upholstered seat only (US). Upholstered seat and back (UP). Ballistic nylon (BN). Heavy Duty (HD).



*Best
Featured with SitOnIt Seating's
Venice — Gold Dusk*

FREELANCE

EFFECTIVE FEBRUARY 23, 2026 | GSA SIN #: 33721

MULTIPURPOSE CHAIR, COUNTER STOOL AND BAR STOOL

STOOL SPECIFICATIONS

Model:	5213 S9 / 5214 S9 24" Counter Stool	5213 S2 / 5214 S2 30" Bar Stool
Dimensions		
Overall Width Armless	21.5"	21.5"
Overall Width With Arms	25"	25"
Overall Depth	24"	24"
Overall Height	39"	45"
Seat Width	19.5"	19.5"
Seat Depth	18.5"	18.5"
Seat Height	24"	30"
Back Width	19.5"	19.5"
Back Height	16"	16"
Materials		
COM	0.99 yd (US)	0.99 yd (US)
	0.99 yd (US) (BN)	0.99 yd (US) (BN)
	1.25 yd (UP)	1.25 yd (UP)
	1.15 yd (UP) (BN)	1.15 yd (UP) (BN)
COL	15 sq ft (US)	15 sq ft (US)
	15 sq ft (US) (BN)	15 sq ft (US) (BN)
	25 sq ft (UP)	25 sq ft (UP)
	21 sq ft (UP) (BN)	21 sq ft (UP) (BN)
Weight and Capacity		
Weight Armless	24 lb	26 lb
Weight With Arms	26 lb	28 lb
Weight Capacity Warranty	300 lb (Plastic/US/UP)	300 lb (Plastic/US/UP)

Upholstered seat only (US). Upholstered seat and back (UP). Ballistic nylon back (BN).



Stool
Featured with SitOnIt Seating's
Venice — Sundown

Freelance

BARIATRIC CHAIR

Built for durability. Imagine the versatility.

The transitional design of Freelance bariatric side chairs works well in lobby areas and offices. The comfortable, curved seat and structural integrity has made it a high-demand, multipurpose chair. Three frame/arm finish combinations create variety. The Freelance collection is ideal for heavy-duty and bariatric applications.



30" Bariatric
Featured with SitOnIt Seating's Sugar — Electric Blue

EFFECTIVE FEBRUARY 23, 2026

Featured Models

30" BARIATRIC :: \$961

30" bariatric side, performance multi-surface glides, grade 1 textile



42" BARIATRIC :: \$1,378

42" bariatric side, performance multi-surface glides, grade 1 textile

Features

- Three frame/arm finish combinations: black and silver/slate
- Fully upholstered
- Waterfall seat
- Molded shroud underside
- Wall-saver frame design
- 600 lb weight capacity warranty on 30" model;
1,000 lb capacity on 42" model

1. Seat

Seat Size	Code	Price	
30" Seat With Arms (600 lb Weight Capacity)	5314	\$961	
42" Seat With Arms (1,000 lb Weight Capacity)	5414	\$1,378	

See the Super Duty Guide on [page 121](#) for additional high weight capacity models.

BARIATRIC CHAIR

2. Frame

Frame Finish	Code	Price	
2-Day Lead Time			
Black	FB	+ \$0	
Silver	FS	+ \$0	

Arm color will match the frame color unless otherwise specified.

3. Base

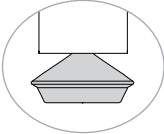
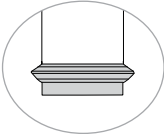
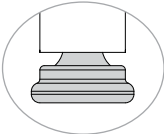
Glides	Code	Price	
Performance Multi-Surface Glides	GL2	+ \$0	
Floor Saver Glides	G12	+ \$17	
Steel Glides (Carpet Only)	G13	+ \$17	



42" Bariatric
Featured with SitOnIt Seating's Huntington – Splash

4. Arms

Arm Color	Code	Price
Black	AC3	+ \$0
Slate	AC4	+ \$0



Arm color will match the frame color unless otherwise specified.

5. Material

Protection	Code	Price
Fire Retardancy		
CAL 133, Fabric, Quantities 1–49	133F	+ \$99
CAL 133, Fabric, Quantities 50+	133F5	+ \$55
CAL 133, Leather, Any Quantity	133L	+ \$119
Ballistic Nylon Back		
Ballistic Nylon Back	BN	+ \$0
Seat and Back Textile		
Fabric/Vinyl Grade 1	FG1/VG1	+ \$0
COM	COM	+ \$42
Fabric/Vinyl Grade 2	FG2/VG2	+ \$42
Fabric/Vinyl Grade 3	FG3/VG3	+ \$84
Fabric/Vinyl Grade 4	FG4/VG4	+ \$156
Fabric/Vinyl Grade 5	FG5/VG5	+ \$228
Fabric/Vinyl Grade 6	FG6/VG6	+ \$304
Fabric/Vinyl Grade 7	FG7/VG7	+ \$378
Leather Grade 1	LG1	+ \$240
COL	COL	+ \$540
Leather Grade 2	LG2	+ \$540
Leather Grade 3	LG3	+ \$820
Leather/Ballistic Grade 2	BN2	+ \$379
Leather/Ballistic Grade 3	BN3	+ \$631

Please reference the [Textile Reference Guide](#) for pricing on fabric over grade 7 and leather over grade 3. Additional CAL 133 information can be found on [page 12](#).

Please reference the [Fabric information](#) found on [page 18](#) for pricing on multi-upholstery.

BARIATRIC CHAIR

6. Packaging

Packaging	Code	Price
Fully Assembled in a Carton	AC	+ \$0

SPECIFICATIONS

Model:	5314 30" Bariatric Chair	5414 42" Bariatric Chair
Dimensions		
Overall Width With Arms	36.5"	48.5"
Overall Depth	25.5"	25.5"
Overall Height	32.5"	35"
Seat Width	30"	42"
Seat Depth	19"	18"
Seat Height	19"	19"
Back Width	30"	42"
Back Height	16"	16"
Materials		
COM	2.25 yd 1.67 yd (BN)	2.5 yd 1.75 yd (BN)
COL	40 sq ft 30 sq ft (BN)	42 sq ft 40 sq ft (BN)
Weight and Capacity		
Weight With Arms	42.5 lb	62.5 lb
Weight Capacity Warranty	600 lb	1,000 lb

Ballistic nylon (BN).

InFlex

MULTIPURPOSE CHAIR, COUNTER STOOL AND BAR STOOL

Geometry in motion.

Designed by Giancarlo Piretti, this multipurpose, stacking chair offers contemporary styling and spine-friendly comfort—at an affordable price.

Versatile InFlex comes in both plastic stacking side models and upholstered side, task and stool versions. The contemporary styling of this Piretti chair emulates the human spine. Its innovative flex-back disc system, with 13 degrees of back angle range, is as clever as it is comfortable.



Good
Featured with a Lagoon shell

EFFECTIVE FEBRUARY 23, 2026

Featured Models

GOOD :: \$402

4-leg chair, all plastic seat and back, armless, standard multi-surface glides

BETTER :: \$467

4-leg chair, plastic back, upholstered seat, armless, standard multi-surface glides, grade 1 textile



BEST :: \$590

4-leg chair, upholstered seat and back, fixed cantilever arms, standard multi-surface glides, grade 1 textile

Features

- Giancarlo Piretti design
- Innovative disc system emulates the human spine
- Plastic model stack five on the floor, 12 on the optional cart
- Upholstered armless model stack five on the floor; 10 on the optional cart
- Fully upholstered, upholstered seat or plastic
- Nine plastic colors
- Two frame finishes
- 300 lb weight capacity warranty
- Complements InFlex light task chair and stool; see [page 111](#)

1. Back

Seat and Back Style	Code	Price	
Plastic	No Code	\$402	
Upholstered Seat Only	US	\$467	
Upholstered Seat and Back	UP	\$532	

Do not stack upholstered chairs with arms.

MULTIPURPOSE CHAIR, COUNTER STOOL AND BAR STOOL

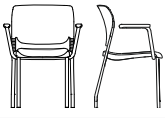
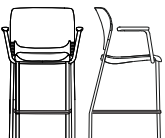
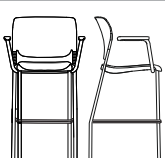

2. Frame

Frame Type	Code	Price	
4-Leg	971	+ \$0	
4-Leg With Black Carpet Casters	974	+ \$40	
24" Counter Stool	971 S9	+ \$150	
30" Bar Stool	971 S2	+ \$150	

Frame Finish	Code	Price	
Black	FC1	+ \$0	
Silver	FC2	+ \$0	

Counter (S9) and bar (S2) stools are available with glides only.

Arms

Arm Style	Code	Price	
Armless	A0	+ \$0	
Fixed Cantilever	A121	+ \$58	

3. Arms (Cont.)

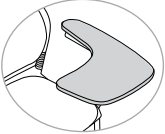
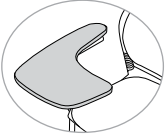
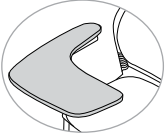
Tablet Arms	Code	Price	
3-Week Lead Time			
Tablet Arm, Left	TLI	+ \$200	
Tablet Arm, Right	TRI	+ \$200	
Oversized Tablet Arm, Right	TIO	+ \$300	
Tablet Laminate Color	Code	Price	
Black	1	+ \$0	
Tablet Edge Color	Code	Price	
Black	TE1	+ \$0	

Tablet arms are not available with stools or casters. Not stackable. Tablet arms are not available with stools or casters. Not stackable.

4. Base

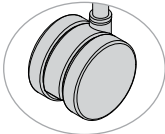
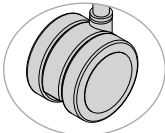
Casters or Glides	Code	Price	
Casters			
Carpet Casters	C13	+ \$0	
Hard Floor and Carpet Casters	C12	+ \$40	

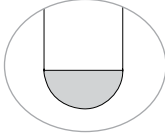
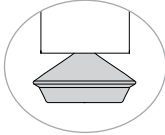
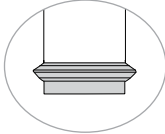

MULTIPURPOSE CHAIR, COUNTER STOOL AND BAR STOOL

4. Base (Cont.)

Casters or Glides (Cont.)	Code	Price	
Glides			
Standard Multi-Surface Glides	G11	+ \$0	
Performance Multi-Surface Glides	GL2	+ \$20	
Floor Saver Glides	G12	+ \$20	
Steel Glides (Carpet Only)	G13	+ \$20	

Please use caution when stacking models with casters to prevent frame damage. SitOnIt Seating does not warrant scratched frames.

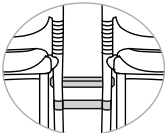
5. Miscellaneous

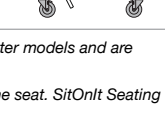
Accessories	Code	Price	
Ganging Bracket for Armless Models	GG9	+ \$30	
Ganging Bracket for Models With Arms	GA9	+ \$30	
Stacking Cart	97-Cart	+ \$399	

Ganging brackets and stacking carts are not intended for use with caster models and are compatible with glides only.

Due to the nature of upholstery, stacking may cause impressions on the seat. SitOnIt Seating does not warrant the effects of stacking on upholstery.

See [page 127](#) for additional stacking requirements.

6. Material

Protection	Code	Price
Fire Retardancy		
CAL 133, Fabric, Quantities 1–49	133F	+ \$99
CAL 133, Fabric, Quantities 50+	133F5	+ \$55
CAL 133, Plastic, Any Quantity	133P	+ \$45
Shell Color (For Plastic and US)	Code	Price
Arctic	SC21	+ \$0
Black	SC1	+ \$0
Chocolate	SC4	+ \$0
Lagoon	SC15	+ \$0
Latte	SC20	+ \$0
Navy	SC5	+ \$0
Red	SC19	+ \$0
Slate	SC8	+ \$0
Sterling	SC18	+ \$0
Textile	Code	Price
Seat Only (For US)		
Fabric/Vinyl Grade 1	FG1/VG1	+ \$0
COM	COM	+ \$24
Fabric/Vinyl Grade 2	FG2/VG2	+ \$24
Fabric/Vinyl Grade 3	FG3/VG3	+ \$45
Fabric/Vinyl Grade 4	FG4/VG4	+ \$77
Fabric/Vinyl Grade 5	FG5/VG5	+ \$116
Fabric/Vinyl Grade 6	FG6/VG6	+ \$159
Fabric/Vinyl Grade 7	FG7/VG7	+ \$200
Seat and Back (For UP)		
Fabric/Vinyl Grade 1	FG1/VG1	+ \$0
COM	COM	+ \$36
Fabric/Vinyl Grade 2	FG2/VG2	+ \$36
Fabric/Vinyl Grade 3	FG3/VG3	+ \$74
Fabric/Vinyl Grade 4	FG4/VG4	+ \$121
Fabric/Vinyl Grade 5	FG5/VG5	+ \$174
Fabric/Vinyl Grade 6	FG6/VG6	+ \$235
Fabric/Vinyl Grade 7	FG7/VG7	+ \$296

Please reference the [Textile Reference Guide](#) for pricing on fabric over grade 7. Additional CAL 133 information can be found on [page 12](#).

Please reference the [Fabric information](#) found on [page 18](#) for pricing on multi-upholstery.

MULTIPURPOSE CHAIR, COUNTER STOOL AND BAR STOOL

7. Packaging

Packaging	Code	Price
Fully Assembled in a Carton	AC4	+ \$0
Fully Assembled Stools in a Carton, Individually Packaged	AC1	+ \$20
Fully Assembled Chairs in a Carton, Individually Packaged	AC1	+ \$20

SPECIFICATIONS

Model:	971 / 974 Multipurpose Chair	971 S9 24" Counter Stool	971 S2 30" Bar Stool
Dimensions			
Overall Width Armless	20"	19.75"	19.75"
Overall Width With Arms	24.125"	25"	25"
Overall Depth	22"	22.25"	22.25"
Overall Height	33"	38.5"	43.5"
Seat Width	17"	16.75"	16.75"
Seat Depth	17"	18.5"	18.5"
Seat Height	18"	24"	29"
Back Width	20"	19.75"	19.75"
Back Height	15.5"	15.5"	15.5"
Materials			
COM	0.85 yd (US) 1 yd (UP)	0.85 yd (US) 1 yd (UP)	0.85 yd (US) 1 yd (UP)
Stacking			
Max Cart Stacking	12 (Plastic) 10 (US/UP)	N/A	N/A
Max Floor Stacking	5	5	5
Weight and Capacity			
Weight Armless	18 lb	22 lb	23 lb
Weight With Arms	22 lb	26 lb	27 lb
Weight Capacity Warranty	300 lb	300 lb	300 lb

Upholstered seat only (US). Upholstered seat and back (UP).

Ioniq

SIDE CHAIR

Inspire unique.

There's a specialness that flows through Ioniq. Its form and feeling are fluid—from the way the arms stretch seamlessly out of a sculpted shell to base options that are as varied and versatile as the spaces they occupy. Because when you desire aesthetics that elevate any experience and offer something refreshingly different, there's only one go-to. And that's Ioniq.



Ioniq Side
Featured with SitOnIt Seating's
Venice — Sundown

EFFECTIVE FEBRUARY 23, 2026

Featured Models

SIDE :: \$765

4-leg, chrome finish, plastic back with upholstered seat pad, integrated arms, standard multi-surface glides, grade 1 textile

Features

- Breathable back with built-in lumbar support
- Edge-to-edge cushion
- Fully integrated armrests
- Single-piece sculpted shell
- 4-leg base
- 300 lb weight capacity warranty

1. Frame

Frame Type	Code	Price	
------------	------	-------	--

4-Leg	1151 FT1	\$765	
-------	----------	-------	--

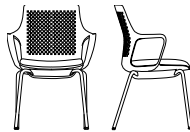

Frame Finish	Code	Price	
--------------	------	-------	--

Chrome	FC15	+ \$0	
--------	------	-------	--

Do not stack Ioniq side chairs. Frames are not stackable.

2. Seat and Back

Seat and Back Style	Code	Price	
---------------------	------	-------	--

Plastic Back With Upholstered Seat Pad	US PB	+ \$0	
--	-------	-------	--



3. Base

Glides	Code	Price	
--------	------	-------	--

Standard Multi-Surface Glides	GL1	+ \$0	
-------------------------------	-----	-------	--

SIDE CHAIR

4. Material

Shell Color	Code	Price	
Black	SC1	+ \$0	
White	SC26	+ \$0	
Seat Textile	Code	Price	
Fabric/Vinyl Grade 1	FG1/VG1	+ \$0	
COM	COM	+ \$24	
Fabric/Vinyl Grade 2	FG2/VG2	+ \$24	
Fabric/Vinyl Grade 3	FG3/VG3	+ \$45	
Fabric/Vinyl Grade 4	FG4/VG4	+ \$77	
Fabric/Vinyl Grade 5	FG5/VG5	+ \$116	
Fabric/Vinyl Grade 6	FG6/VG6	+ \$159	
Fabric/Vinyl Grade 7	FG7/VG7	+ \$200	
Leather Grade 1	LG1	+ \$140	
COL	COL	+ \$200	
Leather Grade 2	LG2	+ \$200	
Leather Grade 3	LG3	+ \$280	

Please reference the [Textile Reference Guide](#) for pricing on fabric over grade 7.

5. Packaging

Packaging	Code	Price	
Fully Assembled in a Carton	AC	+ \$0	

One per carton only.

SPECIFICATIONS

Model:	1151 FT1 4-Leg Multipurpose Chair
Dimensions	
Overall Width	23"
Overall Depth	21.38"
Overall Height	32.5"
Seat Width	17.5"
Seat Depth	17.38"
Seat Height	17.63"
Back Width	18"
Back Height	17.38"
Materials	
COM	0.75 yd
COL	7 sq ft
Weight and Capacity	
Weight	15.5 lb
Weight Capacity Warranty	300 lb

Lumin

MULTIPURPOSE CHAIR, COUNTER STOOL AND BAR STOOL

Light up the room.

Lumin is an elegant multipurpose stackable chair designed for exceptional support and comfort in corporate and education applications. The contoured seat dissipates pressure points for greater comfort while the perforated back adds contemporary style and comfortable breathability. The Lumin multipurpose stackable chair, counter and bar stools are available in black, silver or chrome frame finish with matching arm pad colors. Refined, sophisticated Lumin will light up the room.



Good
Featured with a Pacific shell

EFFECTIVE FEBRUARY 23, 2026

Featured Models

GOOD :: \$347

4-leg chair, plastic seat and back, armless, standard multi-surface glides

BETTER :: \$412

4-leg chair, upholstered seat, armless, standard multi-surface glides, grade 1 textile

BEST :: \$535

4-leg chair, upholstered seat and back, fixed arms, standard multi-surface glides, grade 1 textile

Features

- Contemporary design
- 4-leg and wire rod chair, counter and bar stools
- Exceptional support and comfort
- Fully upholstered, upholstered seat or plastic
- 14 plastic shell colors
- Three frame finishes with matching arm pads
- Left or right folding tablet arm in two finishes
- Built-in pull handle
- Clean-out space
- 4-leg plastic model stacks six on the floor; eight on the optional cart
- Wire frame plastic model stacks eight on the floor; 15 on the optional cart
- 300 lb weight capacity warranty
- Complements Lumin light task chair and stool; see [page 121](#)

1. Frame

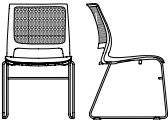
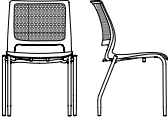
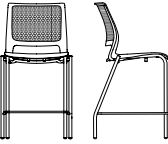
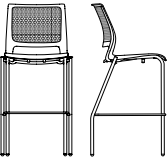
Frame Type	Code	Price	
Wire Rod	1011 FT2	\$324	
4-Leg	1011 FT1	\$347	
24" Counter Stool	1011 FT1 S9	\$497	
30" Bar Stool	1011 FT1 S2	\$497	

Counter (S9) and bar (S2) stools are only available with glides.



MULTIPURPOSE CHAIR, COUNTER STOOL AND BAR STOOL

1. Frame (Cont.)



Frame Finish	Code	Price	
Black	FC1	+ \$0	
Silver (For 4-Leg Frame)	FC2	+ \$0	
Chrome (For Wire Rod Frame)	FC15	+ \$0	

Arms and glides, if specified, are black for black frames and fog for silver or chrome frames.

2. Back

Back and Seat Style	Code	Price	
Plastic Seat	PS	+ \$0	
Upholstered Seat Only	US	+ \$65	
Upholstered Seat and Back	UP	+ \$130	

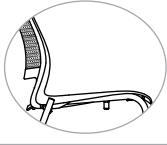
3. Arms

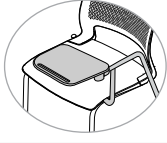
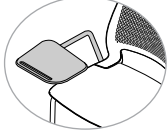
Arm Style	Code	Price	
Armless	A0	+ \$0	
Fixed (For 4-Leg Frame)	A147	+ \$58	
Fixed (For Wire Rod Frame)	A146	+ \$58	
Tablet Arm	Code	Price	
Folding Tablet Arm, Left	RMTL	+ \$200	
Folding Tablet Arm, Right	RMTR	+ \$200	

Tablet arms are not available with stools (S9/S2). Tablet arms are not stackable. Tablet arm will be black for black (FC1) frame or fog for silver (FC2) frame.

4. Base

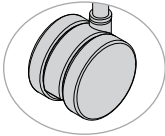
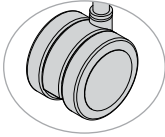
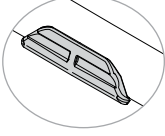
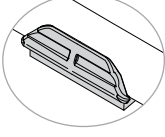
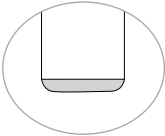
Casters or Glides	Code	Price	
Casters			
Carpet Casters	C13	+ \$40	
Hard Floor and Carpet Casters	C12	+ \$80	
Glides for Wire Rod Frames			
No Glides	G0	+ \$0	
Clear Glides	CGR	+ \$9	
Clear Glides With Felt	CGRF	+ \$27	
Glides for 4-Leg Frames			
Standard Multi-Surface Glides	GL1	+ \$0	
Floor Saver Glides	GL3	+ \$20	
Steel Glides (Carpet Only)	GL4	+ \$20	
Performance Multi-Surface Glides	GL2	+ \$20	

Counter (S9) and bar (S2) stools are only available with glides.

Please use caution when stacking models with casters to prevent frame damage. SitOnIt Seating does not warrant scratched frames.

5. Miscellaneous

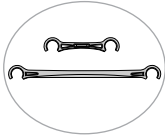
Ganging	Code	Price	
Ganging Bracket for 4-Leg Armless Models	GG10	+ \$30	
Ganging Bracket for 4-Leg Models With Arms	GA10	+ \$30	
Ganging Bracket for Wire Rod Armless Models	GG3	+ \$30	
Ganging Bracket for Wire Rod Models With Arms	GA3	+ \$30	

MULTIPURPOSE CHAIR, COUNTER STOOL AND BAR STOOL

5. Miscellaneous

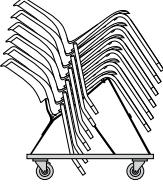
Stacking	Code	Price	
Stacking Cart	1011-CART	+ \$399	

Stacking carts require assembly.

Ganging brackets and stacking carts are not intended for use with caster models and are compatible with glides only. See [page 127](#) for additional stacking requirements.

6. Material

Protection	Code	Price	
Fire Retardancy			
CAL 133, Fabric, Quantities 1-49	133F	+ \$64	
CAL 133, Fabric, Quantities 50+	133F5	+ \$20	
CAL 133, Plastic, Any Quantity	133P	+ \$10	



Best
Featured with a Lemon shell and SitOnIt Seating's Venice — Gold Dusk

6. Material (Cont.)

Shell Color	Code	Price
Apple	SC24	+ \$0
Arctic	SC21	+ \$0
Bisque	SC7	+ \$0
Black	SC1	+ \$0
Chocolate	SC4	+ \$0
Lagoon	SC15	+ \$0
Latte	SC20	+ \$0
Lemon	SC25	+ \$0
Navy	SC5	+ \$0
Pacific	SC22	+ \$0
Red	SC19	+ \$0
Slate	SC8	+ \$0
Sterling	SC18	+ \$0
Tangerine	SC23	+ \$0

Textile	Code	Price
Seat Only (For US)		
Fabric/Vinyl Grade 1	FG1/VG1	+ \$0
COM	COM	+ \$24
Fabric/Vinyl Grade 2	FG2/VG2	+ \$24
Fabric/Vinyl Grade 3	FG3/VG3	+ \$45
Fabric/Vinyl Grade 4	FG4/VG4	+ \$77
Fabric/Vinyl Grade 5	FG5/VG5	+ \$116
Fabric/Vinyl Grade 6	FG6/VG6	+ \$159
Fabric/Vinyl Grade 7	FG7/VG7	+ \$200
Seat and Back (For UP)		
Fabric/Vinyl Grade 1	FG1/VG1	+ \$0
COM	COM	+ \$36
Fabric/Vinyl Grade 2	FG2/VG2	+ \$36
Fabric/Vinyl Grade 3	FG3/VG3	+ \$74
Fabric/Vinyl Grade 4	FG4/VG4	+ \$121
Fabric/Vinyl Grade 5	FG5/VG5	+ \$174
Fabric/Vinyl Grade 6	FG6/VG6	+ \$235
Fabric/Vinyl Grade 7	FG7/VG7	+ \$296

Please reference the [Textile Reference Guide](#) for pricing on fabric over grade 7. Additional CAL 133 information can be found on [page 12](#).

Please reference the [Fabric information](#) found on [page 18](#) for pricing on multi-upholstery.

MULTIPURPOSE CHAIR, COUNTER STOOL AND BAR STOOL

7. Packaging

Packaging	Code	Price
Fully Assembled in a Carton	AC	+ \$0
Fully Assembled in a Carton, Individually Packaged	AC1	+ \$20

CHAIR SPECIFICATIONS

Model:	1011 FT1 4-Leg Multipurpose Chair	1011 FT2 Wire Rod Multipurpose Chair
Dimensions		
Overall Width Armless	21.3" (Glides) 22.3" (Casters)	20.7"
Overall Width With Arms	26.8"	24.9"
Overall Depth	22.1"	22.8"
Overall Height	32.9"	32.9"
Seat Width	19"	19"
Seat Depth	18.7"	18.7"
Seat Height	17.3"	17.3"
Back Width	18.3"	18.3"
Back Height	16.7"	16.7"
Materials		
COM	0.85 yd (US) 1 yd (UP)	0.85 yd (US) 1 yd (UP)
Stacking		
Max Cart Stacking	8 (PS), 6 (US/UP)	15 (PS), 6 (US/UP)
Max Floor Stacking	6 (PS), 4 (US/UP)	8 (PS), 4 (US/UP)
Weight and Capacity		
Weight Armless	13 lb (PS), 13.8 lb (US), 14.3 lb (UP)	15 lb (PS), 15.8 lb (US), 16.3 lb (UP)
Weight With Arms	14 lb (PS), 14.8 lb (US), 15.3 lb (UP)	18.5 lb (PS), 19.3 lb (US), 19.8 lb (UP)
Weight Capacity Warranty	300 lb	300 lb

Upholstered seat only (US). Upholstered seat and back (UP).

MULTIPURPOSE CHAIR, COUNTER STOOL AND BAR STOOL

STOOL SPECIFICATIONS

Model:	1011 S9 24" Counter Stool	1011 S2 30" Bar Stool
Dimensions		
Overall Width Armless	21.3"	21.3"
Overall Width With Arms	26.8"	26.8"
Overall Depth	22.1"	22.1"
Overall Height	40"	45.1"
Seat Width	19"	19"
Seat Depth	18.7"	18.7"
Seat Height	24.25"	29.5"
Back Width	18.3"	18.3"
Back Height	16.7"	16.7"
Materials		
COM	0.85 yd (US) 1 yd (UP)	0.85 yd (US) 1 yd (UP)
Weight and Capacity		
Weight Armless	17 lb	20.3 lb
Weight With Arms	18.7 lb	21.9 lb
Weight Capacity Warranty	300 lb	300 lb

Upholstered seat only (US). Upholstered seat and back (UP).



Better
Featured with a Tangerine shell and
SitOnIt Seating's Malibu — Ruby

Mika

MULTIPURPOSE CHAIR, COUNTER STOOL AND BAR STOOL

Design above.

Mika sits above most others in its class—and not just because it was a multi-award winner. Mika is elevated. Upholstered or non-upholstered, it reaches new heights in what a molded shell chair can be. From top to bottom, the design flows. Back and forth, the design rocks with 15 degrees of flex. Up and up, the design pushes an upholstered seat farther than ever before. And in the end, you arrive at a place of sit-ability and stack-ability hard to find in something that looks this good.



Best
Featured with a Fog shell and
SitOnIt Seating's Dash — Sky



reddot winner 2021



EFFECTIVE FEBRUARY 23, 2026

Featured Models

GOOD :: \$426

4-leg, all plastic, armless,
standard multi-surface glides

BETTER :: \$502

Wire rod, upholstered seat, armless, no
glides, grade 1 textile



BEST :: \$525

4-leg, upholstered seat, armless,
standard multi-surface glides,
grade 1 textile

Features

- Designed by ITO Design
- Single-piece shell with 15 degrees of backrest flex
- Sculpted shell provides a natural cradle
- Optional 2/3 upholstered seat available in 15,000+ textiles
- Base options include 4-leg, wire rod, wire rod counter stool and wire rod bar stool
- Three neutral shell colors
- White, black, fog and chrome frame finishes
- Wire rod model stacks up to 30 chairs on a cart
- Upholstered 4-leg model stacks up to nine chairs on the floor
- 300 lb weight capacity warranty

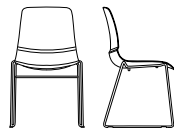
1. Frame

Frame Type	Code	Price	
4-Leg	1101 FT1	\$426	
Wire Rod	1101 FT2	\$403	
24" Wire Rod Counter Stool	1101 FT2 S9	\$553	
30" Wire Rod Bar Stool	1101 FT2 S2	\$553	

MULTIPURPOSE CHAIR AND BAR STOOL

1. Frame

Frame Finish	Code	Price	
For 4-Leg Frame (FT1)			
Black	FC1	+ \$0	
Fog	FC13	+ \$0	
White	FC12	+ \$0	
For Wire Rod Frame (FT2)			
Black	FC1	+ \$0	
Chrome	FC15	+ \$0	

2. Seat

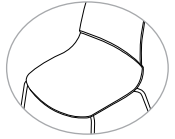
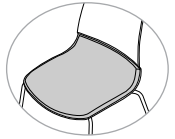
Seat Style	Code	Price	
Plastic Seat	PS	+ \$0	
Upholstered Seat (2/3 Upholstered Wrap)	US	+ \$99	



3. Arms

Arm Style	Code	Price	
Armless	AR0	+ \$0	

4. Base

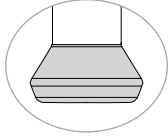
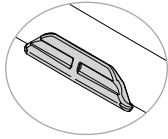
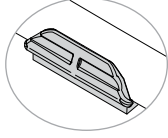
Glides	Code	Price	
For 4-Leg Frame (FT1)			
Standard Multi-Surface Glides	GL1	+ \$0	
For Wire Rod Frame (FT2)			
No Glides	G0	+ \$0	
Clear Glides	CGR	+ \$9	
Clear Glides With Felt	CGRF	+ \$27	

5. Miscellaneous

Accessories	Code	Price	
Stacking Cart	CART	+\$399	

Stacking carts require assembly.

Please use caution when stacking to prevent frame damage. SitOnIt Seating does not warrant scratched frames.

Due to the nature of upholstery, stacking may cause impressions on the seat. SitOnIt Seating does not warrant the effects of stacking on upholstery.

Wire rod bar stools (S2) do not stack on cart. See [page 127](#) for additional stacking requirements.

MULTIPURPOSE CHAIR AND BAR STOOL

6. Material

Protection	Code	Price	
Fire Retardancy			
CAL 133, Fabric, Quantities 1–49	133F	+ \$64	
CAL 133, Fabric, Quantities 50+	133F5	+ \$20	
CAL 133, Plastic, Any Quantity	133P	+ \$10	
Shell Color	Code	Price	
Black	SC1	+ \$0	
White	SC26	+ \$0	
Fog	SC27	+ \$0	
Seat Textile (For US)	Code	Price	
Fabric/Vinyl Grade 1	FG1/VG1	+ \$0	
COM	COM	+ \$24	
Fabric/Vinyl Grade 2	FG2/VG2	+ \$24	
Fabric/Vinyl Grade 3	FG3/VG3	+ \$45	
Fabric/Vinyl Grade 4	FG4/VG4	+ \$77	
Fabric/Vinyl Grade 5	FG5/VG5	+ \$116	
Fabric/Vinyl Grade 6	FG6/VG6	+ \$159	
Fabric/Vinyl Grade 7	FG7/VG7	+ \$200	

Please reference the [Textile Reference Guide](#) for pricing on fabric over grade 7. Additional CAL 133 information can be found on [page 12](#).

7. Packaging

Packaging	Code	Price	
Fully Assembled in a Carton	AC	+ \$0	
Fully Assembled in a Carton, Individually Packaged	AC1	+ \$20	

CHAIR SPECIFICATIONS

Model:	1101 FT1 4-Leg Chair	1101 FT2 Wire Rod Chair
Dimensions		
Overall Width	22.75"	19.65"
Overall Depth	19.5"	19.5"
Overall Height	32.15"	32.4"
Seat Width	17.5"	17.5"
Seat Depth	16.75"	16.75"
Seat Height	18.5"	18.5"
Back Width	16.25"	16.25"
Back Height	16.25"	16.25"
Materials		
COM	0.85 yd	0.85 yd
Stacking		
Max Floor Stacking	3 (PS) 9 (US)	3 (PS) 6 (US)
Max Cart Stacking	12 (PS) 12 (US)	30 (PS) 12 (US)
Weight and Capacity		
Weight	15 lb	14.5 lb
Weight Capacity Warranty	300 lb	300 lb

Plastic seat (PS). Upholstered seat (US).

STOOL SPECIFICATIONS

Model:	1101 FT2 S9 Wire Rod Counter Stool	1101 FT2 S2 Wire Rod Bar Stool
Dimensions		
Overall Width	21.5"	22"
Overall Depth	20.25"	22.9"
Overall Height	39.5"	45.75"
Seat Width	17.5"	17.5"
Seat Depth	16.75"	16.75"
Seat Height	24.25"	30.25"
Back Width	16.25"	16.25"
Back Height	16.25"	16.25"
Materials		
COM	0.85 yd	0.85 yd
Stacking		
Max Floor Stacking	3 (PS) 3 (US)	3 (PS) 3 (US)
Max Cart Stacking	N/A	N/A
Weight and Capacity		
Weight	18 lb	19.5 lb
Weight Capacity Warranty	300 lb	300 lb

Plastic seat (PS). Upholstered seat (US).

Movi

NESTER CHAIR

Lean back. Nest easy.

Meet the last nester you'll ever need. Whether you're setting up, breaking down or making space for spontaneous collaboration, today's modern workplace calls for high-design seating solutions that can keep up with it all.

Enter Movi: our ultra-lightweight nester with a slim, modern frame and extra flexibility built right in for long-range comfort all day long.



*Mesh-back
Featured with aqua mesh and
SitOnIt Seating's Dash – Dove*

EFFECTIVE FEBRUARY 23, 2026

Featured Models

ARMLESS MESH-BACK :: \$823

Mesh back, upholstered seat in grade 1 textile, black frame and base, armless, carpet casters

MESH-BACK :: \$907

Mesh back, upholstered seat with grade 1 textile, white frame and base, fixed arms, carpet casters

UPHOLSTERED BACK :: \$1,028

Multi-upholstery, upholstered seat in grade 2 vinyl, upholstered back in grade 1 textile, fog frame and base, fixed arms, casters

Features

- Flexes at the hip 14 degrees for enhanced comfort
- Clean-out space for easy maintenance
- Bleach-cleanable mesh back (10:1)
- Upholstered back with outer plastic shell offers essential durability + cleanability
- 15,000+ textiles including bleach cleanable, multi-upholstery and more
- 12 breathable mesh options offer cool comfort
- Three base frame and caster colors
- Three back frame and arm colors
- Carpet, hard floor and carpet casters available
- 300 lb weight capacity warranty
- Movi nester complements Movi light task chair and stool; see [page 88](#)

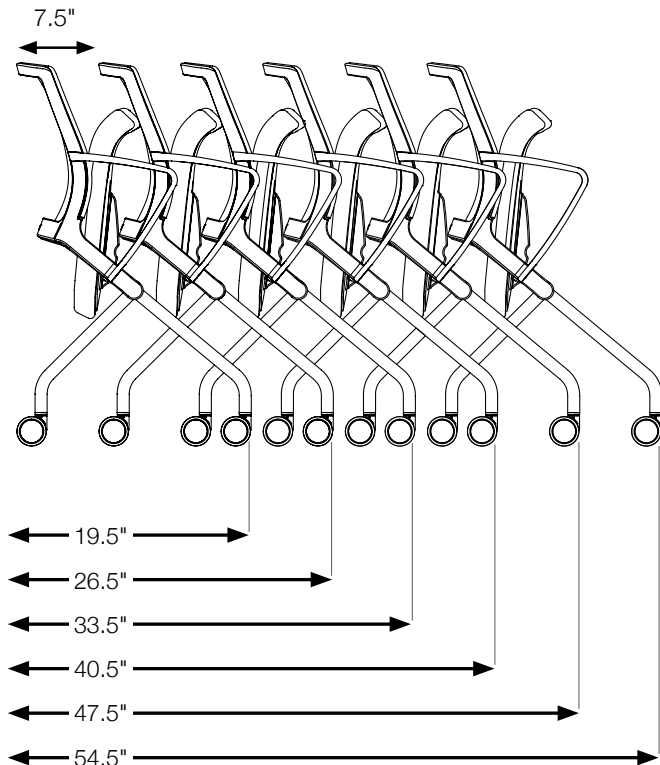

NESTER CHAIR

1. Model

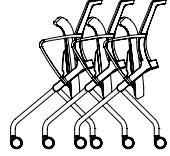
Back Material	Code	Price	
Nester	1061 FT4	\$872	

2. Back

Back Material	Code	Price	
Mesh Back	MB	+ \$0	

Upholstered Back	UB	+ \$39	
------------------	----	--------	---

Back Frame Finish	Code	Price	
Black	SC1	+ \$0	
Fog	SC27	+ \$35	
White	SC26	+ \$35	

3. Arms

Arm Style	Code	Price	
Armless	AR0	- \$49	

Fixed Loop Arms	AR1	+ \$0	
-----------------	-----	-------	---

Arms (AR1) will match back frame color.

4. Base

Base Frame and Caster Color	Code	Price	
Black Base With Black Casters	FC1	+ \$0	
Silver Base With Fog Casters	FC2	+ \$0	
White Base With Fog/White Casters	FC12	+ \$0	

Castors or Glides	Code	Price	
Castors			

Carpet Castors	CS5	+ \$0	
Hard Floor and Carpet Castors	CS6	+ \$40	

Glides			
---------------	--	--	--

Bell Glides (Black)	CS20	+ \$30	
---------------------	------	--------	--

5. Material

Protection	Code	Price	
Fire Retardancy (Seat Only)			
CAL 133, Fabric, Quantities 1-49	133F	+ \$99	
CAL 133, Fabric, Quantities 50+	133F5	+ \$55	

Mesh Color	Code	Price	
Apple	MC31	+ \$0	
Aqua	MC30	+ \$0	
Desert	MC22	+ \$0	
Electric Blue	MC24	+ \$0	
Fire	MC25	+ \$0	
Fog	MC23	+ \$0	
Grape	MC26	+ \$0	
Lemon	MC27	+ \$0	
Nickel	MC21	+ \$0	
Ocean	MC29	+ \$0	
Onyx	MC20	+ \$0	
Tangerine	MC28	+ \$0	

Cal 133 options are only available on mesh back (MB) models.

NESTER CHAIR

5. Material (Cont.)

Fully Upholstered	Code	Price	
Mesh Back (Seat Only)			
Fabric/Vinyl Grade 1	FG1/VG1	+ \$0	
COM	COM	+ \$24	
Fabric/Vinyl Grade 2	FG2/VG2	+ \$24	
Fabric/Vinyl Grade 3	FG3/VG3	+ \$45	
Fabric/Vinyl Grade 4	FG4/VG4	+ \$77	
Fabric/Vinyl Grade 5	FG5/VG5	+ \$116	
Fabric/Vinyl Grade 6	FG6/VG6	+ \$159	
Fabric/Vinyl Grade 7	FG7/VG7	+ \$200	



*Upholstered Back
Featured with SitOnIt Seating's Slide — Electric Blue
and SitOnIt Seating's Malibu — Cobalt*

NESTER CHAIR

5. Material (Cont.)

Fully Upholstered	Code	Price
Upholstered Back (Seat and Back)		
Fabric/Vinyl Grade 1	FG1/VG1	+ \$0
COM	COM	+ \$36
Fabric/Vinyl Grade 2	FG2/VG2	+ \$36
Fabric/Vinyl Grade 3	FG3/VG3	+ \$74
Fabric/Vinyl Grade 4	FG4/VG4	+ \$121
Fabric/Vinyl Grade 5	FG5/VG5	+ \$174
Fabric/Vinyl Grade 6	FG6/VG6	+ \$235
Fabric/Vinyl Grade 7	FG7/VG7	+ \$296
Multi-Upholstery	Code	Price
Multi-Upholstery Upcharge	UMU	+\$58
Seat Upholstery Only		
Fabric/Vinyl Grade 1	FG1/VG1	+ \$0
COM	COM	+ \$24
Fabric/Vinyl Grade 2	FG2/VG2	+ \$24
Fabric/Vinyl Grade 3	FG3/VG3	+ \$45
Fabric/Vinyl Grade 4	FG4/VG4	+ \$77
Fabric/Vinyl Grade 5	FG5/VG5	+ \$116
Fabric/Vinyl Grade 6	FG6/VG6	+ \$159
Fabric/Vinyl Grade 7	FG7/VG7	+ \$200
Back Upholstery Only		
Fabric/Vinyl Grade 1	FG1/VG1	+ \$0
COM	COM	+ \$20
Fabric/Vinyl Grade 2	FG2/VG2	+ \$20
Fabric/Vinyl Grade 3	FG3/VG3	+\$39
Fabric/Vinyl Grade 4	FG4/VG4	+\$63
Fabric/Vinyl Grade 5	FG5/VG5	+\$91
Fabric/Vinyl Grade 6	FG6/VG6	+\$123
Fabric/Vinyl Grade 7	FG7/VG7	+\$154

Please reference the [Textile Reference Guide](#) for pricing on fabric over grade 7. Additional CAL 133 information can be found on [page 12](#).

6. Packaging

Packaging	Code	Price
Fully Assembled In a Carton	AC	+ \$0
Assembled in Bag (Southern California Only)	AB	+ \$0

SPECIFICATIONS

Model:	1061 FT4 Nester Chair
Dimensions	
Overall Width With Arms	23"
Overall Width Armless	21"
Overall Depth	22.75"
Overall Height	34.5" (MB), 34.75" (UB)
Seat Width	19"
Seat Depth	17"
Seat Height	18"
Back Width	18"
Back Height	18" (MB), 18.25" (UB)
Materials	
COM (Back)	1 yd
COM (Seat)	1 yd
COM (Seat and Back)	1.25 yd
Weight and Capacity	
Weight With Arms	20 lb (MB), 25 lb (UB)
Weight Armless	19 lb (MB), 24 lb (UB)
Weight Capacity Warranty	300 lb

Meshback (MB), Upholstered Back (UB)

Orbix

MULTIPURPOSE CHAIR AND BAR STOOL

Everything you need (and more).

More design in a stacker. More comfort in a sit. More models to match the needs of any space. The robust build of Orbix® features an ultra-supportive and extra-wide backrest with hundreds of diamond-cut perforations for unmatched breathability and the comfort to breeze through safe and distanced get-togethers. It sets up quickly, stacks up easily, and stores away conveniently.



Good
Featured with a Navy shell

EFFECTIVE FEBRUARY 23, 2026

Featured Models

GOOD :: \$251

Multipurpose chair, plastic seat and back, armless, no glides

BETTER :: \$325

Multipurpose chair, upholstered seat, plastic back, armless, clear glides, grade 1 textile



BEST :: \$401

Multipurpose chair, upholstered seat, plastic back, fixed arms, clear glides with felt, grade 1 textile

Features

- Consistent, cohesive look with a broad statement of line offers options to fit any space
- Upscale stacking chair with bold lines and striking detail
- Ultra-supportive, extra-wide backrest provides lasting comfort
- Hundreds of diamond-cut perforations offer unmatched breathability and visual transparency
- Integrated clean-out makes it easy to wipe down, set up, stack and store away
- Collection options include wire rod, bar stool, light task chair and stool; see [page 147](#) for Orbix light task chair and stool;
- Plastic wire rod stacks six on the floor (25 on a cart); plastic bar stool stacks six on the floor
- Black or chrome frame finish and 14 shell colors coordinate with optional arm pads and upholstered seat

1. Frame

Frame Type	Code	Price	
Wire Rod Chair	1131 FT2	\$251	
30" Bar Stool	1131 FT2 S2	\$401	
Frame Type	Code	Price	
Black	FC1	+ \$0	
Chrome	FC15	+ \$0	

MULTIPURPOSE CHAIR AND BAR STOOL

2. Seat and Back

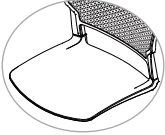
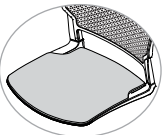
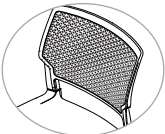
Seat Style	Code	Price	
Plastic	PS	+ \$0	
Upholstered	US	+ \$65	
Back Style	Code	Price	
Plastic	PB	+ \$0	

Do not stack upholstered chairs.



Best
Featured with a Latte shell and SitOnIt Seating's Huntington – Meteor

3. Arms

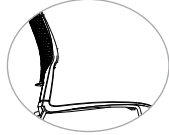
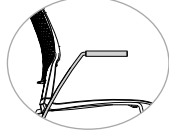
Arm Style	Code	Price	
Armless	AR0	+ \$0	
Fixed	AR1	+ \$58	

Available on wire rod chairs only.

4. Base

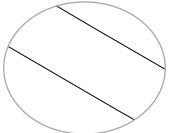
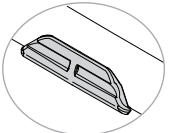
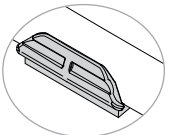
Glides	Code	Price	
No Glides	G0	+ \$0	
Clear Glides	CGR	+ \$9	
Clear Glides With Felt	CGRF	+ \$27	

5. Miscellaneous

Accessories	Code	Price	
Ganging Bracket for Armless Models	GG	+ \$30	
Ganging Bracket for Models With Arms	GA	+ \$30	
Stacking Cart	CART	+ \$399	

Stacking carts require assembly.
See [page 127](#) for additional stacking requirements.

MULTIPURPOSE CHAIR AND BAR STOOL

6. Material

Shell Color	Code	Price	
Arctic	SC21	+ \$0	
Black	SC1	+ \$0	
Chocolate	SC4	+ \$0	
Latte	SC20	+ \$0	
Lagoon	SC15	+ \$0	
Navy	SC5	+ \$0	
Slate	SC8	+ \$0	
Sterling	SC18	+ \$0	

Seat Textile	Code	Price	
Fabric/Vinyl Grade 1	FG1/VG1	+ \$0	
COM	COM	+ \$24	
Fabric/Vinyl Grade 2	FG2/VG2	+ \$24	
Fabric/Vinyl Grade 3	FG3/VG3	+ \$45	
Fabric/Vinyl Grade 4	FG4/VG4	+ \$77	
Fabric/Vinyl Grade 5	FG5/VG5	+ \$116	
Fabric/Vinyl Grade 6	FG6/VG6	+ \$159	
Fabric/Vinyl Grade 7	FG7/VG7	+ \$200	

Please reference the [Textile Reference Guide](#) for pricing on fabric over grade 7 and leather over grade 3. Additional CAL 133 information can be found on [page 12](#).

7. Packaging

Packaging	Code	Price	
Fully Assembled In a Carton	AC	+ \$0	
Fully Assembled In a Carton, Individually Packaged	AC1	+ \$20	

EFFECTIVE FEBRUARY 23, 2026 | GSA SIN #: 33721

SPECIFICATIONS

	1131 FT2 Wire Rod Chair	1131 FT2 S2 Bar Stool
Dimensions		
Overall Width Armless	20"	20"
Overall Width With Arms	24.75"	N/A
Overall Depth	21.75"	22.5"
Overall Height	33.25"	45.5"
Seat Width	18.25"	18.25"
Seat Depth	17.25"	17.25"
Seat Height	18"	30"
Back Width	19.75"	19.75"
Back Height	17.5"	17.5"
Materials		
COM	0.75 yd	0.75 yd
Stacking		
Max Cart Stacking	25 (PS)	N/A
Max Floor Stacking	6 (PS)	6 (PS)
Weight and Capacity		
Weight Armless	13 lb (PS)	21 lb (PS)
	14 lb (US)	22 lb (US)
Weight With Arms	16 lb (PS)	N/A
	17 lb (US)	
Weight Capacity Warranty	300 lb	300 lb

Plastic seat (PS). Upholstered seat (US).



Better
 Featured with a Slate shell and
 SitOnIt Seating's Sugar – Electric Blue

Qwiz

NESTER CHAIR

Nest brilliantly.

From classrooms to training rooms, the need to get in groups can pop up without warning – and Qwiz® is the perfect answer. It's a smart, fun and versatile nester that makes coming together for collaboration or leaving the room with inspiration quick, easy and comfortable.



Mesh
Featured with a Lemon mesh and
SitOnIt Seating's Dash – Dove

EFFECTIVE FEBRUARY 23, 2026

Featured Models

PLASTIC :: \$551

Plastic seat and back, armless, black shell and frame, carpet casters

MESH :: \$684

Upholstered seat, mesh back, armless, white shell and frame, carpet casters, grade 1 textile

UPHOLSTERED :: \$746

Upholstered seat and back, fog shell and frame, fixed arms, carpet casters, grade 1 textile

Features

- Caster design and flip-up seat for high-density nesting
- Perforated seat and back for breathability
- Three shell and frame colors
- 12 bleach-cleanable mesh back colors
- Upholstered seat or fully upholstered
- Interlocking system for easy ganging
- Available as an armless option
- Performance casters and standard multi-surface glides available
- 300 lb weight capacity warranty

1. Frame

Frame Type	Code	Price	
Nesting	1141 FT4	\$581	

Shell and Frame Finish	Code	Price	
Black	SC1	+ \$0	
Fog	SC27	+ \$35	
White	SC26	+ \$35	

2. Seat

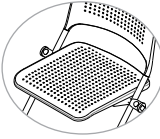
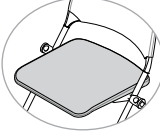
Seat Style	Code	Price	
Plastic Seat	PS	+ \$0	
Upholstered Seat	US	+ \$65	

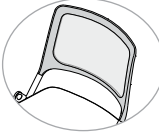
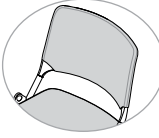

NESTER CHAIR

3. Back

Back Style	Code	Price	
Plastic Back	PB	+ \$0	
Mesh Back	MB	+ \$33	
Upholstered Back	UB	+ \$65	

Upholstered back (UB) is only available with upholstered seat (US).

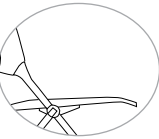
4. Arms

Arm Style	Code	Price	
Armless	AR0	- \$30	
Fixed	AR1	+ \$0	

Arm caps will match shell color.

5. Base

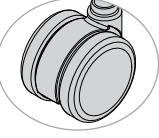
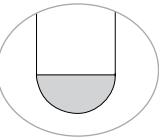
Casters or Glides	Code	Price	
Casters			
Carpet Casters	CS5	+ \$0	
Hard Floor and Carpet Casters	CS6	+ \$40	
Glides			
Standard Multi-Surface Glides	GL1	+ \$30	

Casters, glides and interlock system are black for black shell and frame (SC1) and fog for both fog (SC27) or white (SC26) shells and frames.

6. Material

Mesh Color (For MB)	Code	Price	
Apple	MC31	+ \$0	
Aqua	MC30	+ \$0	
Desert	MC22	+ \$0	
Electric Blue	MC24	+ \$0	
Fire	MC25	+ \$0	
Fog	MC23	+ \$0	
Grape	MC26	+ \$0	
Lemon	MC27	+ \$0	
Nickel	MC21	+ \$0	
Ocean	MC29	+ \$0	
Onyx	MC20	+ \$0	
Tangerine	MC28	+ \$0	
Protection	Code	Price	
Fire Retardancy			
CAL 133, Fabric, Quantities 1–49	133F	+ \$64	
CAL 133, Fabric, Quantities 50+	133F5	+ \$20	
CAL 133, Plastic, Any Quantity	133P	+ \$10	

Additional CAL 133 information can be found on [page 12](#).



Plastic
Featured with a black shell

NESTER CHAIR

6. Material (Cont.)

Textile	Code	Price	
Seat Only (For US)			
Fabric/Vinyl Grade 1	FG1/VG1	+ \$0	
COM	COM	+ \$24	
Fabric/Vinyl Grade 2	FG2/VG2	+ \$24	
Fabric/Vinyl Grade 3	FG3/VG3	+ \$45	
Fabric/Vinyl Grade 4	FG4/VG4	+ \$77	
Fabric/Vinyl Grade 5	FG5/VG5	+ \$116	
Fabric/Vinyl Grade 6	FG6/VG6	+ \$159	
Fabric/Vinyl Grade 7	FG7/VG7	+ \$200	
Seat and Back (For UB)			
Fabric/Vinyl Grade 1	FG1/VG1	+ \$0	
COM	COM	+ \$36	
Fabric/Vinyl Grade 2	FG2/VG2	+ \$36	
Fabric/Vinyl Grade 3	FG3/VG3	+ \$74	
Fabric/Vinyl Grade 4	FG4/VG4	+ \$121	
Fabric/Vinyl Grade 5	FG5/VG5	+ \$174	
Fabric/Vinyl Grade 6	FG6/VG6	+ \$235	
Fabric/Vinyl Grade 7	FG7/VG7	+ \$296	

Please reference the [Textile Reference Guide](#) for pricing on fabric over grade 7.

Due to the nature of vinyl upholstery, nesting may cause impressions on the seat. SitOnIt Seating does not warrant the effects of nesting on vinyl upholstery.

7. Packaging

Packaging	Code	Price	
Fully Assembled In a Carton	AC	+ \$0	
Fully Assembled In a Carton, Individually Packaged	AC1	+ \$20	

EFFECTIVE FEBRUARY 23, 2026 | GSA SIN #: 33721

SPECIFICATIONS

Model:	1141 FT4 Nester
Dimensions	
Overall Width With Arms	22"
Overall Width Armless	22"
Overall Depth	22.5"
Overall Height	32"
Seat Width	16.4"
Seat Depth	17"
Seat Height	17.75" (PS) 18" (US/UB)
Back Width	18.5"
Back Height	15"
Arm Height	25.5"
Materials	
COM	0.75 yd (US) 1 yd (US/UB)
Weight and Capacity	
Weight With Arms	15 lb
Weight Armless	13 lb
Weight Capacity Warranty	300 lb

Plastic seat (PS). Upholstered seat only (US). Upholstered seat and back (US/UB).

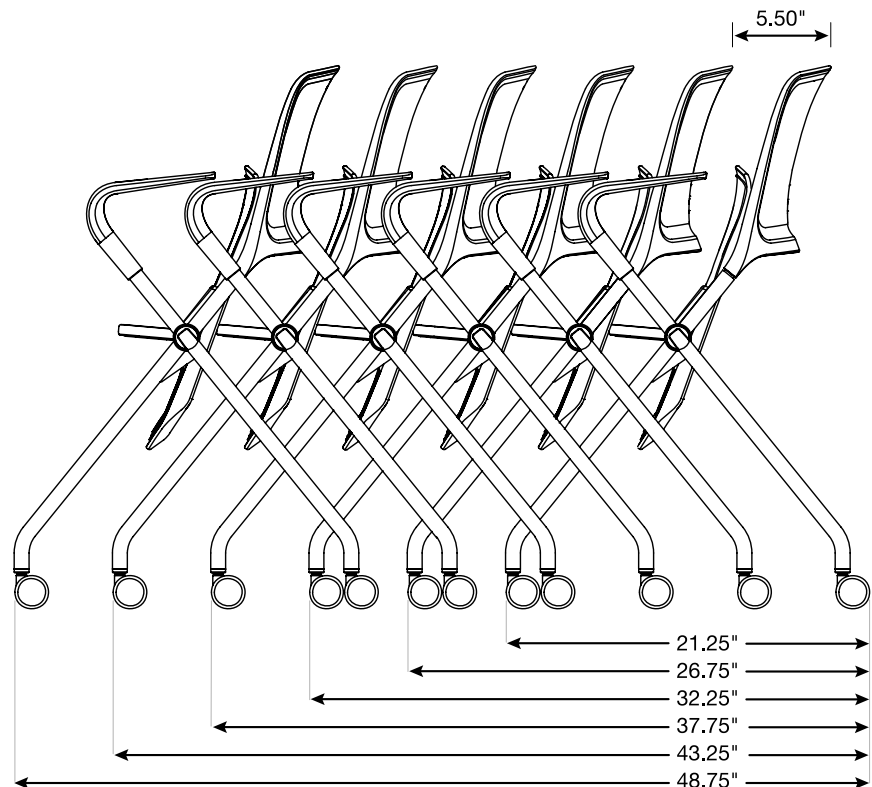

Relay

NESTER CHAIR

Durable and adaptable to the finish.

Great to look at, Relay provides lasting comfort in a stylish design that makes an appealing multipurpose seating option for meeting, training, conference and break rooms. The seat and back are molded from high-impact thermoplastic for lasting durability and comfort. Add the optional upholstered seat and back for a more sophisticated, inviting look and added comfort. Relay nesting chairs are available in black or silver frame and come with casters standard.



*Good
Featured with a Navy shell*

Featured Models

GOOD :: \$480

All plastic, armless, casters

BETTER :: \$545

Plastic back, upholstered seat, armless, casters, grade 1 textile



BEST :: \$668

Upholstered seat and back, fixed cantilever arms, casters, grade 1 textile

Features

- Structurally reinforced and durable back
- High-impact polypropylene
- Fully upholstered, upholstered seat or plastic
- Nine plastic colors
- Armless or with fixed cantilever arms
- Black or silver frame
- 17 chairs in 10 feet of space
- Wall-saver frame design
- 250 lb weight capacity

1. Back

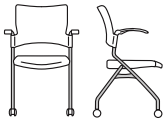
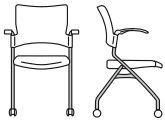

Back and Seat Style	Code	Price	
Plastic	No Code	\$480	
Upholstered Seat Only	US	\$545	
Upholstered Seat and Back	UP	\$610	

2. Frame

Frame Finish	Code	Price	
Black With Black Carpet Casters	94XB	+ \$0	
Silver With Black Carpet Casters	94XS	+ \$0	

NESTER CHAIR

3. Arms

Arm Style	Code	Price	
Armless	A0	+ \$0	
Fixed Cantilever	A60	+ \$58	

4. Base

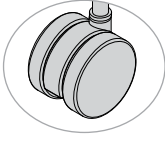
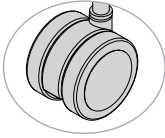
Casters	Code	Price	
Black Carpet Casters	C13	+ \$0	
Hard Floor and Carpet Casters	C12	+ \$40	

5. Miscellaneous

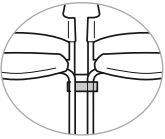
Accessories	Code	Price	
Ganging Bracket for Nester Models	GA10	+ \$30	

6. Material

Protection	Code	Price
Fire Retardancy		
CAL 133, Fabric, Quantities 1–49	133F	+ \$99
CAL 133, Fabric, Quantities 50+	133F5	+ \$55
CAL 133, Plastic, Any Quantity	133P	+ \$45
Shell Color	Code	Price
Arctic	SC21	+ \$0
Black	SC1	+ \$0
Chocolate	SC4	+ \$0
Lagoon	SC15	+ \$0
Latte	SC20	+ \$0
Navy	SC5	+ \$0
Red	SC19	+ \$0
Slate	SC8	+ \$0
Sterling	SC18	+ \$0
Textile	Code	Price
Seat Only (US)		
Fabric/Vinyl Grade 1	FG1/VG1	+ \$0
COM	COM	+ \$24
Fabric/Vinyl Grade 2	FG2/VG2	+ \$24
Fabric/Vinyl Grade 3	FG3/VG3	+ \$45
Fabric/Vinyl Grade 4	FG4/VG4	+ \$77
Fabric/Vinyl Grade 5	FG5/VG5	+ \$116
Fabric/Vinyl Grade 6	FG6/VG6	+ \$159
Fabric/Vinyl Grade 7	FG7/VG7	+ \$200
Seat and Back (UP)		
Fabric/Vinyl Grade 1	FG1/VG1	+ \$0
COM	COM	+ \$36
Fabric/Vinyl Grade 2	FG2/VG2	+ \$36
Fabric/Vinyl Grade 3	FG3/VG3	+ \$74
Fabric/Vinyl Grade 4	FG4/VG4	+ \$121
Fabric/Vinyl Grade 5	FG5/VG5	+ \$174
Fabric/Vinyl Grade 6	FG6/VG6	+ \$235
Fabric/Vinyl Grade 7	FG7/VG7	+ \$296

Please reference the [Textile Reference Guide](#) for pricing on fabric over grade 7. Additional CAL 133 information can be found on [page 12](#).

Please reference the [Fabric information](#) found on [page 16](#) for pricing on multi-upholstery.

NESTER CHAIR

7. Packaging

Packaging	Code	Price
Fully Assembled in a Carton	AC4	+ \$0
Fully Assembled in a Carton, Individually Packaged	AC1	+ \$20

SPECIFICATIONS

	94X Nester Chair
Dimensions	
Overall Width Armless	24"
Overall Width With Arms	25.75"
Overall Depth	25.25"
Overall Height	33.5"
Seat Width	18.25"
Seat Depth	17.25"
Seat Height	18.5" (Plastic) 19.5" (US/UP)
Back Width	19.125"
Back Height	17"
Weight Armless	21.5 lb
Weight With Arms	22.5 lb
Materials	
COM	0.75 yd (US) 1 yd (UP)
Weight and Capacity	
Weight Armless	21.5 lb
Weight With Arms	22.5 lb
Weight Capacity Warranty	250 lb

Upholstered seat only (US). Upholstered seat and back (UP).

Rio

MULTIPURPOSE CHAIR, COUNTER STOOL AND BAR STOOL

Design that responds to you.

What goes into the award-winning line of Rio® plastic chairs? Patented flexing technology, for one. Our complete family of Rio models feature our patented Active Rebound Control (ARC) Technology®—a performance-minded flexor insert that supports a wide range of motion (20 full degrees to be exact) and responds precisely to the amount of weight pressed against it.

Add a fresh, modern color palette and you've got a seating solution that allows for more movement, day-long comfort and flexibility than any other chair in its class.

The Rio is an easy choice for multi-use spaces that require quick setups and breakdowns. Discover a collection of stackable chairs engineered to allow for better movement, applications across more environments and a longer product life.



Good
Featured with a Lemon shell

EFFECTIVE FEBRUARY 23, 2026

Featured Models

GOOD :: \$319

4-leg chair, plastic seat and back, armless, standard multi-surface glides

BETTER :: \$384

4-leg chair, plastic back, upholstered seat, armless, standard multi-surface glides, grade 1 textile

BEST :: \$507



4-leg chair, upholstered seat and back, fixed arms, standard multi-surface glides, grade 1 textile

**MULTIPURPOSE CHAIR,
COUNTER STOOL AND BAR STOOL**

Features

- 4-leg, wire rod, 24" counter or 30" bar stool
- Exceptional support and comfort
- Fully upholstered, upholstered seat or plastic
- ARC Technology® for weight-assisted flex
- 14 plastic shell colors
- All models offer two frame finishes with matching arm pads
- Left or right folding tablet arm that match the frame finish.
- Easy-grip edge that acts as pull handle
- Clean-out space
- 4-Leg plastic model stacks four on the floor; eight on the optional cart
- Plastic wire rod model stacks six on the floor; 15 on the optional cart
- 300 lb weight capacity warranty
- Complements Rio light task chair and stool; see [page 165](#)

1. Frame

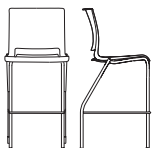

Frame Type	Code	Price	
Wire Rod Chair	1051 FT2	\$309	
4-Leg Chair	1051 FT1	\$319	
24" Counter Stool	1051 FT1 S9	\$469	
30" Bar Stool	1051 FT1 S2	\$469	

1. Frame (Cont.)



Frame Finish	Code	Price	
Black	FC1	+ \$0	
Silver (4-Leg Frame Only FT1)	FC2	+ \$0	
Chrome (Wire Rod Frame Only FT2)	FC15	+ \$0	

Arms and glides, if selected, are black for black frames and fog for silver or chrome frames.

2. Back and Seat

Back and Seat Style	Code	Price	
Plastic	PS	+ \$0	
Upholstered Seat	US	+ \$65	
Upholstered Seat and Back	UP	+ \$130	

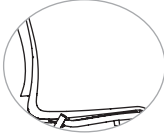
3. Arms

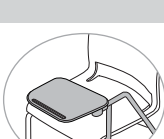
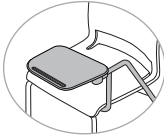
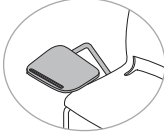
Arm Style	Code	Price	
Armless	A0	+ \$0	
Fixed Arms (4-Leg Frame Only FT1)	A91	+ \$58	
Fixed Arms (Wire Rod Frame Only FT2)	A131	+ \$58	
Tablet Arm			
Folding Tablet Arm, Left	RMTL	+ \$200	
Folding Tablet Arm, Right	RMTR	+ \$200	

Not available with wire rod (FT2) frames or stools (S9/S2). Not stackable. Tablet arm will be black for black (FC1) frame or fog for silver (FC2) frame.

4. Base

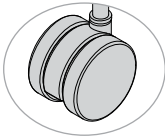
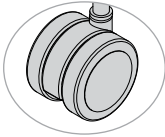
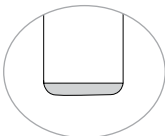
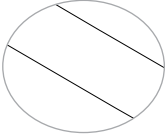
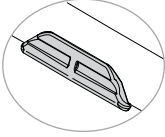
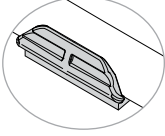
Casters or Glides	Code	Price	
Casters			
Carpet Casters	C13	+ \$40	
Hard Floor and Carpet Casters	C12	+ \$80	
Glides for 4-Leg Chair and Stool Only			
Standard Multi-Surface Glides	GL1	+ \$0	
Floor Saver Glides	GL3	+ \$20	
Steel Glides (Carpet Only)	GL4	+ \$20	
Performance Multi-Surface Glides	GL2	+ \$20	
Glides for Wire Rod Frame Only			
No Glides	G0	+ \$0	
Clear Glides	CGR	+ \$9	
Clear Glides With Felt	CGRF	+ \$27	

Please use caution when stacking models with casters to prevent frame damage. SitOnIt Seating does not warrant scratched frames.

MULTIPURPOSE CHAIR, COUNTER STOOL AND BAR STOOL

5. Miscellaneous

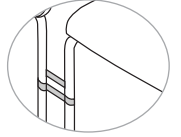
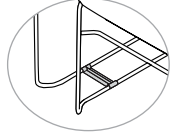
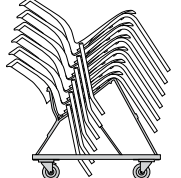
Accessories	Code	Price	
Ganging Bracket (For 4-Leg Chair FT1)	GG12	+ \$30	
Ganging Bracket (For Wire Rod Armless Models)	GG3	+ \$30	
Ganging Bracket (For Wire Rod Models With Arms)	GA4	+ \$30	
Stacking Cart	Cart	+ \$399	

Stacking carts require assembly.

Ganging brackets and stacking carts are not intended for use with caster models and are compatible with glides only. Accessories are not available for stools (S2/S9).

Due to the nature of upholstery, stacking may cause impressions on the seat. SitOnIt Seating does not warrant the effects of stacking on upholstery.

See page 127 for additional stacking requirements.

6. Material

Protection	Code	Price	
Fire Retardancy			
CAL 133, Fabric, Quantities 1-49	133F	+ \$64	
CAL 133, Fabric, Quantities 50+	133F5	+ \$20	
CAL 133, Plastic, Any Quantity	133P	+ \$10	
Shell Color			
Apple	SC24	+ \$0	
Arctic	SC21	+ \$0	
Bisque	SC7	+ \$0	
Black	SC1	+ \$0	
Chocolate	SC4	+ \$0	
Lagoon	SC15	+ \$0	
Latte	SC20	+ \$0	
Lemon	SC25	+ \$0	
Navy	SC5	+ \$0	
Pacific	SC22	+ \$0	
Red	SC19	+ \$0	
Slate	SC8	+ \$0	
Sterling	SC18	+ \$0	
Tangerine	SC23	+ \$0	

6. Material (Cont.)

Textile	Code	Price
Seat Only (US)		
Fabric/Vinyl Grade 1	FG1/VG1	+ \$0
COM	COM	+ \$24
Fabric/Vinyl Grade 2	FG2/VG2	+ \$24
Fabric/Vinyl Grade 3	FG3/VG3	+ \$45
Fabric/Vinyl Grade 4	FG4/VG4	+ \$77
Fabric/Vinyl Grade 5	FG5/VG5	+ \$116
Fabric/Vinyl Grade 6	FG6/VG6	+ \$159
Fabric/Vinyl Grade 7	FG7/VG7	+ \$200
Seat and Back (UP)		
Fabric/Vinyl Grade 1	FG1/VG1	+ \$0
COM	COM	+ \$36
Fabric/Vinyl Grade 2	FG2/VG2	+ \$36
Fabric/Vinyl Grade 3	FG3/VG3	+ \$74
Fabric/Vinyl Grade 4	FG4/VG4	+ \$121
Fabric/Vinyl Grade 5	FG5/VG5	+ \$174
Fabric/Vinyl Grade 6	FG6/VG6	+ \$235
Fabric/Vinyl Grade 7	FG7/VG7	+ \$296

Please reference the [Textile Reference Guide](#) for pricing on fabric over grade 7. Additional CAL 133 information can be found on [page 12](#).

Please reference the [Fabric](#) information found on [page 18](#) for pricing on multi-upholstery.

7. Packaging

Packaging	Code	Price
Fully Assembled In a Carton	AC	+ \$0
Fully Assembled In a Carton, Individually Packaged	AC1	+ \$20

MULTIPURPOSE CHAIR, COUNTER AND BAR STOOL

CHAIR SPECIFICATIONS

Model:	1051 FT1 4-Leg Multipurpose Chair	1051 FT2 Wire Rod Multipurpose Chair
Dimensions		
Overall Width Armless	21.2"	21.2"
Overall Width With Arms	22.2"	22.2"
Overall Depth	21.6"	23.2"
Overall Height	33.4"	33.4"
Seat Width	18.5"	18.5"
Seat Depth	18.2"	18.2"
Seat Height	17.9"	17.9"
Back Width	18.2"	18.2"
Back Height	17.5"	17.5"
Materials		
COM	0.85 yd (US) 1 yd (UP)	0.85 yd (US) 1 yd (UP)
Weight and Capacity		
Weight Armless	12.3 lb	15 lb
Weight With Arms	13.8 lb	18 lb
Weight Capacity Warranty	300 lb	300 lb

Upholstered seat only (US). Upholstered seat and back (UP).

STOOL SPECIFICATIONS

Model:	1051 FT1 S9 24" 4-Leg Counter Stool	1051 FT1 S2 30" 4-Leg Bar Stool
Dimensions		
Overall Width Armless	21.2"	21.2"
Overall Width With Arms	22.2"	22.2"
Overall Depth	22.2"	22.2"
Overall Height	40.35"	45.6"
Seat Width	18.5"	18.5"
Seat Depth	18.2"	18.2"
Seat Height	24.85"	30.1"
Back Width	18.2"	18.2"
Back Height	17.5"	17.5"
Materials		
COM	0.85 yd (US) 1 (UP)	0.85 yd (US) 1 (UP)
Weight and Capacity		
Weight Armless	17 lb	20.3 lb
Weight With Arms	18.7 lb	21.9 lb
Weight Capacity Warranty	300 lb	300 lb

Upholstered seat only (US). Upholstered seat and back (UP).

Rowdy

MULTIPURPOSE CHAIR

Value to shout about.

Rowdy is a one-piece multipurpose chair that will fit any space and any budget. Put Rowdy anywhere from meeting, training and conference rooms to auditorium and theater settings. The built-in hand-hold in the back allows easy repositioning. Stack Rowdy up to 40 high on its optional stacking cart and whisk them away for easy storage when space is at a premium.



Good
Featured with a Slate shell

EFFECTIVE FEBRUARY 23, 2026

Featured Models

GOOD :: \$221

All-plastic seat and back, armless, no glides

BETTER :: \$286

Upholstered seat, plastic back, armless, no glides, grade 1 fabric



BEST :: \$313

Upholstered seat, plastic back, clear glides with felt, grade 1 fabric

Features

- 14 plastic colors
- Built-in pull handle
- Wire-frame construction
- Black or chrome frame
- All plastic models stack 15 on the floor; 40 on the optional cart
- 250 lb weight capacity warranty

1. Seat

Seat Style	Code	Price	
Plastic	No Code	\$221	
Upholstered Seat	US	\$286	

Do not stack upholstered seats.

2. Frame

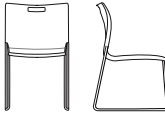
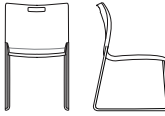

Frame Finish	Code	Price	
Black Wire Rod Base	92 SB	+ \$0	
Chrome Wire Rod Base	92 SC	+ \$0	

MULTIPURPOSE CHAIR

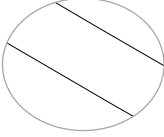

3. Arms

Arm Style	Code	Price	
Armless	A0	+ \$0	

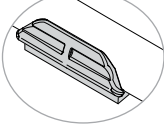
4. Base

Glides	Code	Price	
No Glides	N	+ \$0	
Clear Glides	CGR	+ \$9	
Clear Glides With Felt	CGRF	+ \$27	

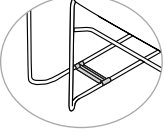
5. Miscellaneous

Accessories	Code	Price	
Ganging Bracket	GG5	+ \$30	
Stacking Cart	CART	+ \$399	

Stacking carts require assembly.

Due to the nature of upholstery, stacking may cause impressions on the seat. SitOnIt Seating does not warrant the effects of stacking on upholstery.

See [page 127](#) for additional stacking requirements.

6. Material

Protection	Code	Price
Fire Retardancy		
CAL 133 Fabric, Quantities 1–49	133F	+ \$99

CAL 133 Fabric, Quantities 50+	133F5	+ \$55
--------------------------------	-------	--------

CAL 133 Plastic, Any Quantity	133P	+ \$45
-------------------------------	------	--------

Shell Color	Code	Price
Apple	SC24	+ \$0
Arctic	SC21	+ \$0
Bisque	SC7	+ \$0
Black	SC1	+ \$0
Chocolate	SC4	+ \$0
Lagoon	SC15	+ \$0
Latte	SC20	+ \$0
Lemon	SC25	+ \$0
Navy	SC5	+ \$0
Pacific	SC22	+ \$0
Red	SC19	+ \$0
Slate	SC8	+ \$0
Sterling	SC18	+ \$0
Tangerine	SC23	+ \$0

Seat Textile (For US)	Code	Price
Fabric/Vinyl Grade 1	FG1/VG1	+ \$0
COM	COM	+ \$24
Fabric/Vinyl Grade 2	FG2/VG2	+ \$24
Fabric/Vinyl Grade 3	FG3/VG3	+ \$45
Fabric/Vinyl Grade 4	FG4/VG4	+ \$77
Fabric/Vinyl Grade 5	FG5/VG5	+ \$116
Fabric/Vinyl Grade 6	FG6/VG6	+ \$159
Fabric/Vinyl Grade 7	FG7/VG7	+ \$200

Please reference the [Textile Reference Guide](#) for pricing on fabric over grade 7.

Stacking vinyl upholstered seat is not covered by warranty.

7. Packaging

Packaging	Code	Price
Fully Assembled in a Carton	AC4	+ \$0
Fully Assembled in a Carton, Individually Packaged	AC1	+ \$20

MULTIPURPOSE CHAIR

SPECIFICATIONS

Model:	92 Wire Rod Multipurpose Chair
Dimensions	
Overall Width	19.5"
Overall Depth	22"
Overall Height	33"
Seat Width	17"
Seat Depth	17"
Seat Height	17.5"
Back Width	19"
Back Height	16"
Materials	
COM	0.75 yd (US)
Stacking	
Max Cart Stacking Armless	40 (Plastic), N/A (Upholstered)
Max Floor Stacking Armless	15 (Plastic), N/A (Upholstered)
Weight and Capacity	
Weight Armless	13 lb
Weight Capacity Warranty	250 lb



Better
Featured with a Tangerine shell
and SitOnIt Seating's Venice — Sundown

Sprout

MULTIPURPOSE CHAIR

*It's friendly—
ergo and eco.*

The supportive, flexing back on Sprout™ provides extra ergonomics while the simple shell + frame construction makes it 100% recyclable (and super easy to maintain). It pairs a refined silhouette with rugged durability and stacks higher than any other chair we have. Whether spread out, stacked up or stored away, Sprout is always ready to thrive.



Better
Featured with the Navy shell

Featured Models

GOOD :: \$252

Plastic seat and back, armless, wire rod base, no glides

BETTER :: \$261

Plastic seat and back, armless, wire rod base, clear glides

Features

- Space-saving design features high-density stacking (up to 40 on a cart and 10 on the floor)
- Ergonomic contouring with 10-degree flexing back provides superior comfort
- Durable and simple shell + frame construction means it's easy to maintain—and is 100% recyclable when it's time to replace
- Slim lines and silhouette complement an array of environments
- Large clean-out makes clean-up quick
- Ganging option locks chairs together effortlessly, creating well-ordered rows for seating
- Nine shell colors and two frame colors
- 300 lb weight capacity warranty

1. Frame

Frame Type	Code	Price	
------------	------	-------	--

Wire Rod Chair

1181 FT2

\$252



Frame Finish	Code	Price	
--------------	------	-------	--

Black

FC1

+ \$0

Chrome

FC15

+ \$0

2. Seat and Back

Seat	Code	Price	
------	------	-------	--

Plastic

PS

+ \$0



Back	Code	Price	
------	------	-------	--

Plastic

PB

+ \$0

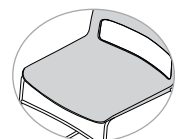

MULTIPURPOSE CHAIR

3. Arms

Arm Style	Code	Price	
-----------	------	-------	--

Armless

AR0

+\$0



4. Base

Glides	Code	Price	
--------	------	-------	--

No Glides

G0

+\$0

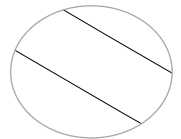

Clear Glides

CGR

+\$9

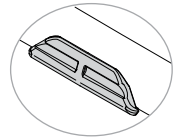

Clear Glides With Felt

CGRF

+\$27

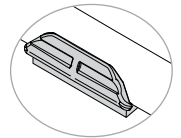

5. Miscellaneous

Accessories	Code	Price	
-------------	------	-------	--

Ganging Bracket

GG

+\$30

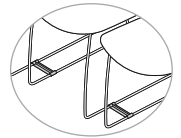

Stacking Cart

CART

+\$399

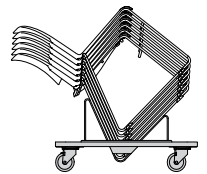

Stacking carts require assembly.

See [page 127](#) for additional stacking requirements.

MULTIPURPOSE CHAIR

6. Material

Shell Color	Code	Price
Arctic	SC21	+\$0
Black	SC1	+\$0
Chocolate	SC4	+\$0
Lagoon	SC15	+\$0
Latte	SC20	+\$0
Navy	SC5	+\$0
Red	SC19	+\$0
Slate	SC8	+\$0
Sterling	SC18	+\$0

7. Packaging

Packaging	Code	Price
Fully Assembled In a Carton	AC	+\$0
Fully Assembled in a Carton, Individually Packaged	AC1	+\$20

SPECIFICATIONS

	Wire Rod 1181 FT2
Dimensions	
Overall Width	21.25"
Overall Depth	22"
Overall Height	32"
Seat Width	18.75"
Seat Depth	16"
Seat Height	18.5"
Back Width	18.5"
Back Height	16"
Stacking	
Maximum Floor Stacking	10
Maximum Cart Stacking	40
Dimensions	
Weight	14.5 lb
Weight Capacity Warranty	300 lb



Stacking Cart

Wit Side

MESH BACK MULTIPURPOSE CHAIR

Work smarter.

A slimmer, stationary version of the task chair, our Wit Side is ideal for high-traffic settings like break rooms and cafeterias. Thanks to its ultra-lightweight frame and identical built-in pull handle, you can swing it around and rearrange spaces easily to accommodate the constant flow of crowded areas.



Good
Featured with Ocean mesh

EFFECTIVE FEBRUARY 23, 2026

Featured Models

GOOD :: \$435

Mesh back, plastic seat, armless, standard multi-surface glides

BETTER :: \$542

Mesh back, upholstered seat, fixed arms, standard multi-surface glides, grade 1 textile

BEST :: \$582

Mesh back, upholstered seat, fixed arms, carpet casters, grade 1 textile

Features

- Complements Wit task chair and Wit task stool
- Upholstered seat or plastic seat in three colors
- 12 mesh back colors
- Built-in pull handle
- Black or silver frame
- Wall-saver frame design
- Textured arm pads
- Stacks four on the floor, four on the optional cart
- Choose from two caster types and four glide options
- 300 lb weight capacity warranty
- Complements by Wit mesh back task chair and stool; see [page 192](#) and [page 196](#)

1. Frame

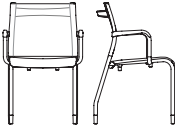
Frame Type	Code	Price	
4-Leg Side	2221 FT1 MB	\$542	

Frame Finish	Code	Price	
Black	FC1	+ \$0	
Silver	FC2	+ \$0	

2. Seat

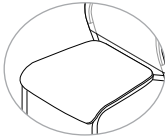
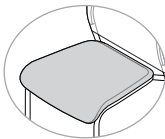
Seat Style	Code	Price	
Plastic Seat	PS	- \$58	
Upholstered Seat	US	+ \$0	

MESH BACK MULTIPURPOSE CHAIR

3. Arms

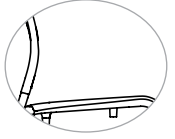
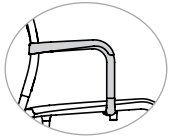
Arm Style	Code	Price	
Armless	AR0	- \$49	
Fixed Loop	AR1	+ \$0	

4. Base

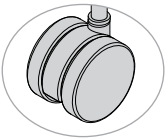
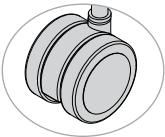
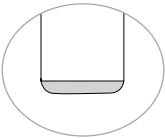
Casters or Glides	Code	Price	
Casters			
Black Carpet Casters	CS5	+ \$40	
Hard Floor and Carpet Casters	CS6	+ \$80	
Glides			
Standard Multi-Surface Glides	GL1	+ \$0	
Floor Saver Glides	GL3	+ \$17	
Steel Glides (Carpet Only)	GL4	+ \$17	
Performance Multi-Surface Glides	GL2	+ \$17	

Please use caution when stacking models with casters to prevent frame damage. SitOnIt Seating does not warrant scratched frames.

5. Miscellaneous

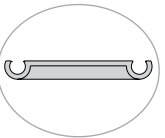
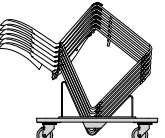
Accessories	Code	Price	
Ganging Brackets for Armless Models	GG	+ \$30	
Ganging Brackets for Models With Arms	GA	+ \$30	
Stacking Cart	CART	+ \$399	

Stacking carts require assembly.

Stacking cart (CART) is not compatible with caster models (CS5/CS6). See [page 127](#) for additional stacking requirements.

Due to the nature of upholstery, stacking may cause impressions on the seat. SitOnIt Seating does not warrant the effects of stacking on upholstery.

6. Material

Protection	Code	Price
Fire Retardancy		
CAL 133, Fabric, Quantities 1-49	133F	+ \$64
CAL 133, Fabric, Quantities 50+	133F5	+ \$20
CAL 133, Leather, Any Quantity	133L	+ \$119
CAL 133, Plastic, Any Quantity	133P	+ \$10
Mesh Color	Code	Price
Apple	MC31	+ \$0
Aqua	MC30	+ \$0
Desert	MC22	+ \$0
Electric Blue	MC24	+ \$0
Fire	MC25	+ \$0
Fog	MC23	+ \$0
Grape	MC26	+ \$0
Lemon	MC27	+ \$0
Nickel	MC21	+ \$0
Ocean	MC29	+ \$0
Onyx	MC20	+ \$0
Tangerine	MC28	+ \$0
Shell Color (For PS)	Code	Price
Black	SC1	+ \$0
Navy	SC5	+ \$0
Slate	SC8	+ \$0
Seat Textile Only (For US)	Code	Price
Fabric/Vinyl Grade 1	FG1/VG1	+ \$0
COM	COM	+ \$24
Fabric/Vinyl Grade 2	FG2/VG2	+ \$24
Fabric/Vinyl Grade 3	FG3/VG3	+ \$45
Fabric/Vinyl Grade 4	FG4/VG4	+ \$77
Fabric/Vinyl Grade 5	FG5/VG5	+ \$116
Fabric/Vinyl Grade 6	FG6/VG6	+ \$159
Fabric/Vinyl Grade 7	FG7/VG7	+ \$200
Leather Grade 1	LG1	+ \$140
COL	COL	+ \$200
Leather Grade 2	LG2	+ \$200
Leather Grade 3	LG3	+ \$280

Please reference the [Textile Reference Guide](#) for pricing on fabric over grade 7 and leather over grade 3. Additional CAL 133 information can be found on [page 12](#).

MESH BACK MULTIPURPOSE CHAIR

7. Packaging

Packaging	Code	Price
Fully Assembled In a Carton	AC3	+ \$0
Individually Packaged	AC1	+ \$20

SPECIFICATIONS

Model:	2221 FT1 MB Mesh Side Chair	2221 FT1 MB Mesh Side Chair With Casters
Dimensions		
Overall Width Armless	19.25"	21.75"
Overall Width With Arms	22.5"	22.5"
Overall Depth	23"	24.5"
Overall Height	33.75"	33.75"
Seat Width	18.5"	18.5"
Seat Depth	16.25"	16.25"
Seat Height	18.07" (PS) 18.53" (US)	18.07" (PS) 18.53" (US)
Back Width	19.25"	19.25"
Back Height	17"	17"
Materials		
COM	0.75 yd	0.75 yd
COL	10 sq ft	10 sq ft
Stacking		
Max Cart Stacking	4	Not Recommended
Max Floor Stacking	4	4
Weight and Capacity		
Cart Stacking Weight Armless	112 lb	Not Recommended
Cart Stacking Weight With Arms	128 lb	Not Recommended
Floor Stacking Weight Armless	62 lb	62 lb
Floor Stacking Weight With Arms	78 lb	78 lb
Weight Armless	14 lb (PS) 15.5 lb (US)	14 lb (PS) 15.5 lb (US)
Weight With Arms	18 lb (PS) 19.5 lb (US)	18 lb (PS) 19.5 lb (US)
Weight Capacity Warranty	300 lb	300 lb

Plastic seat (PS). Upholstered seat (US).

Wit Side

THINTEX BACK MULTIPURPOSE CHAIR

Work smarter.

A slimmer, stationary version of the task chair, our Wit Side is ideal for high-traffic settings like break rooms and cafeterias. Thanks to its ultra-lightweight frame and identical built-in pull handle, you can swing it around and rearrange spaces easily to accommodate the constant flow of crowded areas.



Better
Featured with Aqua thintex
and SitOnIt Seating's Dash — Cloud

EFFECTIVE FEBRUARY 23, 2026

Featured Models

GOOD :: \$476

Thintex back, plastic seat, armless, standard multi-surface glides

BETTER :: \$583

Thintex back, upholstered seat, fixed arms, standard multi-surface glides, grade 1 textile

BEST :: \$623

Thintex back, upholstered seat, fixed arms, carpet casters, grade 1 textile

Features

- Complements Wit task chair and Wit task stool
- Upholstered seat or plastic seat in three colors
- 12 Thintex back colors
- Built-in pull handle
- Black or silver frame
- Wall-saver frame design
- Textured arm pads
- Stacks four on the floor, four on the optional cart
- Choose from two caster types and four glide options
- 300 lb weight capacity warranty
- Complements by Wit task chair and stool; see [page 200](#) and [page 204](#)

1. Frame

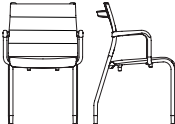
Frame Type	Code	Price	
4-Leg Side	2221 FT1 TXB	\$583	

Frame Finish	Code	Price	
Black	FC1	+ \$0	
Silver	FC2	+ \$0	

2. Back



Back Material	Code	Price	
Fabric	TX1	+ \$0	
Vinyl	TX2	+ \$0	

THINTEX BACK MULTIPURPOSE CHAIR

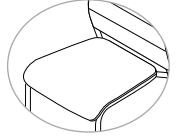
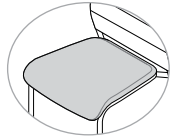
3. Seat

Seat Style	Code	Price	
Plastic Seat	PS	- \$58	
Upholstered Seat	US	+ \$0	

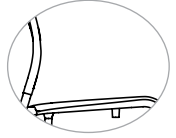
4. Arms

Arm Style	Code	Price	
Armless	AR0	- \$49	
Fixed Loop	AR1	+ \$0	

5. Base

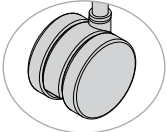
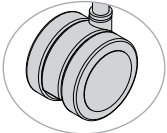
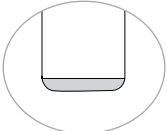
Casters or Glides	Code	Price	
Casters			
Black Carpet Casters	CS5	+ \$40	
Hard Floor and Carpet Casters	CS6	+ \$80	
Glides			
Standard Multi-Surface Glides	GL1	+ \$0	
Floor Saver Glides	GL3	+ \$17	
Steel Glides (Carpet Only)	GL4	+ \$17	
Performance Multi-Surface Glides	GL2	+ \$17	

Please use caution when stacking models with casters to prevent frame damage. SitOnIt Seating does not warrant scratched frames.

6. Miscellaneous

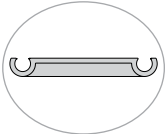
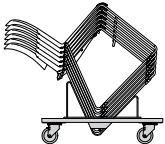
Accessories	Code	Price	
Ganging Brackets for Armless Models	GG	+ \$30	
Ganging Brackets for Models With Arms	GA	+ \$30	
Stacking Cart	CART	+ \$399	

Stacking carts require assembly.

Stacking cart (CART) is not compatible with caster models (CS5/CS6). See [page 127](#) for additional stacking requirements.

Due to the nature of upholstery, stacking may cause impressions on the seat. SitOnIt Seating does not warrant the effects of stacking on upholstery.

7. Material

Protection	Code	Price	
Fire Retardancy			
CAL 133, Fabric, Quantities 1-49	133F	+ \$64	
CAL 133, Fabric, Quantities 50+	133F5	+ \$20	
CAL 133, Leather, Any Quantity	133L	+ \$119	
CAL 133, Plastic, Any Quantity	133P	+ \$10	

Thintex Color	Code	Price	
Apple	MC31	+ \$0	
Aqua	MC30	+ \$0	
Desert	MC22	+ \$0	
Electric Blue	MC24	+ \$0	
Fire	MC25	+ \$0	
Fog	MC23	+ \$0	
Grape	MC26	+ \$0	
Lemon	MC27	+ \$0	
Nickel	MC21	+ \$0	
Ocean	MC29	+ \$0	
Onyx	MC20	+ \$0	
Tangerine	MC28	+ \$0	

Shell Color (For PS)	Code	Price	
Black	SC1	+ \$0	
Navy	SC5	+ \$0	
Slate	SC8	+ \$0	

THINTEX BACK MULTIPURPOSE CHAIR

7. Material (Cont.)

Seat Textile (For US)	Code	Price	
Fabric/Vinyl Grade 1	FG1/VG1	+ \$0	
COM	COM	+ \$24	
Fabric/Vinyl Grade 2	FG2/VG2	+ \$24	
Fabric/Vinyl Grade 3	FG3/VG3	+ \$45	
Fabric/Vinyl Grade 4	FG4/VG4	+ \$77	
Fabric/Vinyl Grade 5	FG5/VG5	+ \$116	
Fabric/Vinyl Grade 6	FG6/VG6	+ \$159	
Fabric/Vinyl Grade 7	FG7/VG7	+ \$200	
Leather Grade 1	LG1	+ \$140	
COL	COL	+ \$200	
Leather Grade 2	LG2	+ \$200	
Leather Grade 3	LG3	+ \$280	

Please reference the [Textile Reference Guide](#) for pricing on fabric over grade 7 or leather over grade 3.



Good
Featured with a Black shell
and Lemon thintex

EFFECTIVE FEBRUARY 23, 2026 | GSA SIN #: 33721

8. Packaging

Packaging	Code	Price
Fully Assembled In a Carton	AC3	+ \$0
Fully Assembled In a Carton, Individually Packaged	AC1	+ \$20

SPECIFICATIONS

Model:	2221 FT1 TXB Thintex Side Chair	2221 FT1 TXB Thintex Side Chair With Casters
Dimensions		
Overall Width Armless	19.25"	21.75"
Overall Width With Arms	22.5"	22.5"
Overall Depth	23"	24.5"
Overall Height	33.75"	33.75"
Seat Width	18.5"	18.5"
Seat Depth	16.25"	16.25"
Seat Height	18.07" (PS) 18.53" (US)	18.07" (PS) 18.53" (US)
Back Width	19.25"	19.25"
Back Height	17"	17"
Materials		
COM	0.75 yd	0.75 yd
COL	10 sq ft	10 sq ft
Stacking		
Maximum Cart Stacking	4	Not Recommended
Maximum Floor Stacking	4	4
Weight and Capacity		
Cart Stacking Weight Armless	112 lb	Not Recommended
Cart Stacking Weight With Arms	128 lb	Not Recommended
Floor Stacking Weight Armless	62 lb	62 lb
Floor Stacking Weight With Arms	78 lb	78 lb
Weight Armless	14 lb (PS) 15.5 lb (US)	14 lb (PS) 15.5 lb (US)
Weight With Arms	18 lb (PS) 19.5 lb (US)	18 lb (PS) 19.5 lb (US)
Weight Capacity Warranty	300 lb	300 lb

Plastic seat (PS). Upholstered seat (US).



Best
Featured with Grape thintex and SitOnIt Seating's Malibu – Violet

Appendix

HELPFUL REFERENCE MATERIAL

SUPER DUTY SERIES GUIDE

Super Duty Series

When it comes to solutions built for uncompromising reliability, durability and comfortability — there's our Super Duty Series. Every side, task and tandem chair in the series features a combination of extra size, width, weight capacity warranty and more.

LIMITED 10-YEAR WARRANTY

SitOnIt Seating warrants the Heavy Duty Series for a period of 10 years when configured to the appropriate model. Fabric and foam cushioning are covered for two years.

TEXTILE DURABILITY

SitOnIt Seating recommends textiles that are high-density and abrasion-resistant, with at least a 75,000 double rub rating.



Heavy Duty

350 LB WEIGHT CAPACITY

- Standard seat and back
- Reinforced seat and heavy duty components
- Task Chairs: Amplify, Focus, ReAlign, and TR2
- Task Stools: Non-Stop Heavy Duty Stool and TR2

Large and Tall

400 LB WEIGHT CAPACITY

- Wide seat and standard back
- Thicker and firmer seat
- Reinforced seat and heavy duty components
- Task Chairs: Amplify, Focus, and Novo

Heavy Duty XL

500 LB WEIGHT CAPACITY

- Widest back and seat
- Thickest and firmest seat and back
- Reinforced seat and back, and heavy duty components
- Task Chair: Non-Stop

SUPER DUTY SERIES GUIDE

Large and Tall Options

SitOnIt Seating Large and Tall (LT) models are available as a standard to provide a fully coordinated and cohesive family offering on our Amplify, Focus and Novo task chairs. Large and Tall accommodates users up to 400 lb and SitOnIt Seating warrants for a period of 10 years used in multi-shift (24/7) applications.

Specify Large and Tall models by using the LT suffix when ordering. Add the appropriate additional charge for each chair. The list below summarizes the model, arm styles, mechanism, frame, back and base options.



Large and Tall (LT) Models

Large and Tall Options (List Price)	Amplify 2723 B1 Y A152 LT	Focus 5623 B1 Y A152 LT	Novo 1033 BK2 Y A152 LT
LT Base Model: Highback, Black Frame, Enhanced Synchro, Height-Adjustable With Sport Arm Pads	\$1,309	\$1,311	\$1,227
1. Arm Styles			
Height-Adjustable With Sport Arm Pads (A152)	+ \$0	+ \$0	+ \$0
Armless (A0)	- \$45	- \$45	- \$45
Height-/Width-Adjustable With Sport Arm Pads (A153)	+ \$35	+ \$35	+ \$35
2. Seat Depth			
Seat Depth Adjustment (E3)	+ \$79	+ \$79	+ \$79
3. Frame			
Back Support Color	Black (FC1)	Black (Z1) or Silver (Z2)	Black (FC1)
4. Back			
Upholstered Back (B3/B4)	N/A	+ \$126	N/A
Adjustable Lumbar (LB1)	+ \$0	+ \$50	+ \$0
5. Base			
Polished Aluminum Base (B5)	+ \$169	+ \$169	+ \$169
Heavy Duty Hard Floor and Carpet Casters (C9)	+ \$61	+ \$61	+ \$61
High Heavy Duty Cylinder (S13)	+ \$0	+ \$0	+ \$0

SUPER DUTY SERIES GUIDE

Side Chair Collection



500 LB WEIGHT CAPACITY

Freelance Heavy Duty; Cora Guest, Hip Chair, Counter Stool and Bar Stool, Kindl 21"



600 LB WEIGHT CAPACITY

Cora Midsize and Freelance 30" Bariatric, Kindl 30"



750 LB WEIGHT CAPACITY

Cora Bariatric, Kindl 42"



1000 LB WEIGHT CAPACITY

Freelance Bariatric 42"

Lounge Collection



500 LB WEIGHT CAPACITY

Aviera Guest Seating, Hip Chair, Patient Seating (21"/24" Seat Width), Freespan Seating (21"/24" Seat Width), Freespan 2-seat, Pre-configured 2-seat and 3-seat



750 LB WEIGHT CAPACITY

Aviera Bariatric Seating 30" and 44" (Metal Only), Freespan 3-Seat

Safety First

To ensure proper cleaning and/or disinfecting, it's important to consult with facilities or safety personnel and follow the manufacturer's instructions—including detailed dilution requirements, safe application instructions, dwell time for effective disinfecting and more.

Per CDC instructions, always read and follow the directions on the label to ensure safe and effective use.

- Wear skin protection and consider eye protection for potential splash hazards
- Ensure adequate ventilation
- Use no more than the amount recommended on the label
- Use water at room temperature for dilution (unless stated otherwise on the label)
- Avoid mixing chemical products
- Label diluted cleaning solutions
- Store and use chemicals out of the reach of children and pets

Always read and follow the directions on the cleaner/disinfectant labels to ensure safe and effective use.

Clean + Disinfect

Cleaning and disinfecting are two distinct actions, and knowing the difference between the two can help promote safety in any space. This comprehensive, 2-step process requires cleaning before disinfecting.

Clean

CLEANING REMOVES GERMS

- The act of removing visible dirt and debris from objects or surfaces
- Cleaning works by using soap/detergent with water to remove impurities from surfaces either manually or mechanically
- Cleaning does not kill germs, but by removing them, it lowers their numbers and risk of spreading infection

Clean (Cont.)

CLEANING GUIDELINES AND TIPS

- Start by lightly dusting with a soft, grit-free cloth or chamois (no wiping)
- After dusting, dampen cloth or chamois with a solution of mild, non-abrasive liquid soap and water
- Wipe clean and dry with a soft, grit-free cloth, sponge or chamois
- Avoid using abrasive cleaners and steel wool to prevent scratching
- Test any cleaning method or agent in an inconspicuous area of the surface

Disinfect

DISINFECTING KILLS GERMS

- This process comes after a surface is cleaned
- Disinfecting kills germs on objects or surfaces with the use of chemicals
- Most common disinfectants include one of the following active ingredients: Quaternary Ammonium (Quats), Sodium Hypochlorite (Bleach), Hydrogen Peroxide, or 70% Isopropyl Alcohol
- EPA-registered disinfectants List N: Disinfectants for Use Against SARS-CoV-2

DISINFECTING GUIDELINES AND TIPS

- Follow the disinfectant manufacturer's instructions when applying the agent
- Once finished, remove all disinfecting agents from the surface with water and a grit-free cloth, then dry
- If not properly removed, disinfectant residue could degrade product life and appearance

Cleaning + Disinfecting efforts should be part of an organization's comprehensive systems-based approach to provide a safe and sustainable workspace.

Cleaning Our Hard Surfaces

Over 95% of the hard surfaces on our products can be cleaned/disinfected using any one of the four primary ingredients listed below.

- Bleach (Sodium Hypochlorite)
- Hydrogen Peroxide
- Quaternary Ammonium Compounds (Quats)
- 70% Isopropyl Alcohol

EXAMPLES OF HARD SURFACES THAT CAN BE DISINFECTED:

- Plastics (i.e. polyurethane and acrylic)
- Solid Surface
- Metals
- Painted Surfaces
- Laminate

EXCEPTIONS:

- Markerboard
- Veneer
- Wood Surfaces

Clean + Disinfect

Cleaning and disinfecting are two distinct actions, and knowing the difference between the two can help promote safety in any space. This comprehensive, 2-step process requires cleaning before disinfecting.

Cleaning Our Soft Surfaces

Our textiles and meshes offer a performance and cleaning story unmatched in the industry.

Our Carded Textile Program offers over 700 bleach-cleanable fabrics through our SitOnIt Seating private label and partnership textile program.

MESH:

- All of our mesh materials are bleach-cleanable. This determination is supported by 3rd-party results from completing AATCC 188 Colorfastness to Bleach testing where the subject material is submerged, and friction stirred in a diluted sodium hypochlorite solution.
- Cleaning of our mesh materials varies. Check out the [Mesh Spec + Care Guide](#) on our website for more information.

SEATING FABRICS:

- Soft surfaces on seating can vary widely from woven, knits and leather to coated textiles such as vinyl and polyurethane. Woven and knits tend to be more permeable than vinyl or polyurethane.
- Cleaning of our seating fabric materials varies. For a list of our textile spec + care guides, see the [Materials Downloads](#) on our website.
- For a list of bleach-cleanable materials, see our [Carded Library](#) and select "Bleach Cleanable" under performance.

SCREEN FABRICS:

- Cleaning of screen materials varies. For a list of our textile spec + care guides, see the [Materials Downloads](#) on our website.
- For a list of bleach-cleanable materials, see our [Carded Library](#) and select "Bleach Cleanable" under performance.

GLIDE GUIDE

For almost 25 years, SitOnIt Seating products have been expertly designed to provide the best comfort and support in the industry.

Glides are an often overlooked element in the seating specification process, but they play a crucial role in ensuring proper interface between the chair and the floor.

This application guide offers general guidelines to assist customers with choosing the best glide for their needs. The guide is based on extensive lab testing and hands-on experience with selling chairs in a variety of environments, as well as review and consultations with glide experts.

Application Guide

Material		Surfaces						
Glide Type (4-Leg)		Carpet	VCT	Vinyl	Laminate	Ceramic Tile	Hardwood	Concrete
Standard Multi-Surface Glides		Acceptable	Acceptable	Acceptable	Better	Better	NR	Better
Performance Multi-Surface Glides	Applies to Anytime, Baja, Cora, Freelance, Focus Side, InFlex, Lumin, Rio and Wit Side	Best	Better	Better	Better	Best	Better	Better
Floor Saver Glides		NR	Best	Best	Best	NR	Best	Best
Steel Glides (Carpet Only)		Better	NR	NR	NR	NR	NR	NR

Material		Surfaces						
Glide Type (Wire Rod)		Carpet	VCT	Vinyl	Laminate	Ceramic Tile	Hardwood	Concrete
No Glides	Applies to Axy's, Baja, Lumin, Mika, Orbix, Rio, Rowdy and Sprout	Best	NR	NR	NR	NR	NR	NR
Glides	Axy's, Baja, Lumin, Mika, Orbix, Rio, Rowdy and Sprout	NR	NR	Acceptable	Better	Better	NR	Acceptable
Clear Glides With Felt	Baja, Lumin, Mika, Orbix, Rio, Rowdy and Sprout	NR	Better	Better	Best	NR	Better	NR

Felt glides are subject to wear and tear and require periodic replacement.

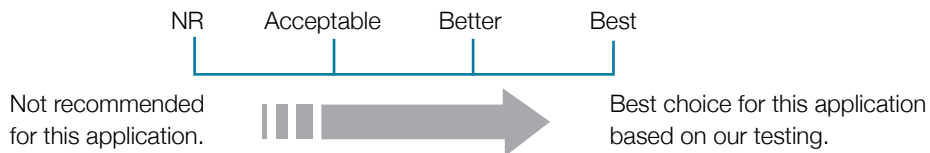

- **BEST:** Best choice for this application based on our testing.
- **BETTER:** Better choice for this application based on our testing.
- **ACCEPTABLE:** Acceptable choice for this application based on our testing but consider BETTER or BEST options.
- **NR:** Not recommended for this application based on our testing.

This Application Guide is provided for informational purposes only. Always follow the manufacturer's instructions for care and maintenance of your flooring. Periodic inspection and maintenance of glides is critical to minimize the risk of damage to your flooring, especially when using glides with floors that are prone to scratching and marring. Testing was performed under simulated conditions. Because a wide range of factors impact actual performance, including how your chairs are used; the state of the glides and flooring; and dirt, moisture and other environmental factors, Exemplis does not warrant you will achieve any specific result. Actual results may vary.

STACKING GUIDE

Discover stacking compatibility with Sitonit Seating's multipurpose products—including a list of SitOnIt models with a wall-saver frame.

4-Leg

Collection	Plastic Seat and Back	Upholstered Seat With Plastic Back	Upholstered Seat and Back	Wall-Saver Frame
On Cart				
Achieve (Glides Only)	—	5	5	•
Anytime (Glides Only)	8	8	8	
Baja (Glides Only)	10	8	8	
Cora Guest (Glides Only)	—	—	6	•
Freelance (Glides Only)	6	6	6	•
InFlex (Glides Only)	12	Arms NR, 10 Armless	Arms NR, 10 Armless	
Lumin (Glides Only)	8	6	6	
Mika (Glides Only)	12	12	—	
Rio (Glides Only)	8	7	7	
On Floor				
Achieve (Casters and Glides)	—	4	4	•
Anytime (Glides Only)	6	6	6	
Baja (Casters and Glides)	6	4	4	
Cora Guest (Casters and Glides)	—	—	4	•
Freelance (Casters and Glides)	4	4	4	•
InFlex (Casters and Glides)	5	Arms NR, 5 Armless	Arms NR, 5 Armless	
Lumin (Casters and Glides)	6	4	4	
Mika (Casters and Glides)	3	9	—	
Rio (Casters and Glides)	4	3	3	

4-Leg Mesh

Collection	Plastic Seat Mesh Back	Upholstered Seat With Mesh Back	Fully Upholstered Seat and Back	Wall-Saver Frame
On Cart				
Focus Side (Glides Only)	—	5	3	•
Wit Side (Glides Only)	4	4	4	•
On Floor				
Focus Side (Glides or Casters)	—	4	3	•
Wit Side (Glides or Casters)	4	NR	NR	•

No bariatric or midsized models are stackable. Relay nester stacks three on the floor; vertical. Ioniq and Qwiz do not stack.

Please note that chairs with a tablet arm do not stack. Chairs with casters do not stack on a cart.

Please use caution when stacking models with casters to prevent frame damage. SitOnIt Seating does not warrant scratched frames.

NR — Not recommended.

Wire Rod

STACKING GUIDE

Collection	Plastic Seat and Back	Upholstered Seat With Plastic Back	Upholstered Seat and Back	Wall-Saver Frame
On Cart				
Baja (Glides Only)	6	4	4	
Lumin (Glides Only)	15	6	6	
Mika	30	12	—	
Orbix	25	NR	—	
Rio (Glides Only)	15	6	6	
Rowdy (Glides Only)	25 With Arms, 40 Armless	NR	NR	
Sprout	40	—	—	
On Floor				
Baja	6	6	6	
Lumin	8	4	4	
Mika	3	6	—	
Orbix	6	NR	—	
Rio	6	5	5	
Rowdy	10 With Arms, 15 Armless	NR	NR	
Sprout	10	—	—	

Nester

Collection	Plastic Seat and Back	Plastic Seat and Mesh Back	Upholstered Seat and Mesh Back	Upholstered Seat and Back
On Floor				
Flytech	3	3	4	4

Stacking with vinyl seats is not recommended.

Stool

Collection	Plastic Seat and Back	Upholstered Seat With Plastic Back	Upholstered Seat and Back	Wall-Saver Frame
On Floor				
Baja	4	4	4	
Mika	3	3	—	
Orbix	6	NR	—	

Bariatric and midsized models are not stackable. Focus Side wood back models are not stackable. Relay nester stacks three on the floor: vertical. Ioniq and Qwiz do not stack.

Please note that chairs with a tablet arm do not stack. Chairs with casters do not stack on a cart.

Please use caution when stacking models with casters to prevent frame damage. SitOnIt Seating does not warrant scratched frames.

NR — Not recommended.

PLASTICS COLOR PROGRAM

From plastic shell colors to mesh colors to custom match colors, SitOnIt Seating gives designers and specifiers lots of options. The table below shows the plastic color options available by collection. All plastic shell colors are available with a 5-day lead time for production.







Plastics

	Anytime	Baja	Flytech	Freelance	Ioniq	InFlex	Lumin	Mika	Orbix	Relay	Qwiz	Rio	Rowdy	Sprout	Wit Side
Apple	—	SC24	—	—	—	—	SC24	—	—	—	—	SC24	SC24	—	—
Arctic	—	SC21	—	SC21	—	SC21	SC21	—	SC21	SC21	—	SC21	SC21	SC21	—
Black	SC1	SC1	SC1	SC1	SC1	SC1	SC1	SC1	SC1	SC1	SC1	SC1	SC1	SC1	SC1
Bisque	—	SC7	—	—	—	—	SC7	—	—	—	—	SC7	SC7	—	—
Chocolate	—	SC4	—	SC4	—	SC4	SC4	—	SC4	SC4	—	SC4	SC4	SC4	—
Fog	—	—	SC27	—	—	—	—	SC27	—	—	SC27	—	—	—	—
Lagoon	—	SC15	—	SC15	—	SC15	SC15	—	SC15	SC15	—	SC15	SC15	SC15	—
Latte	—	SC20	—	SC20	—	SC20	SC20	—	SC20	SC20	—	SC20	SC20	SC20	—
Lemon	—	SC25	—	—	—	—	SC25	—	—	—	—	SC25	SC25	—	—
Navy	SC5	SC5	—	SC5	—	SC5	SC5	—	SC5	SC5	—	SC5	SC5	SC5	SC5
Pacific	—	SC22	—	—	—	—	SC22	—	—	—	—	SC22	SC22	—	—
Red	—	SC19	—	SC19	—	SC19	SC19	—	SC19	SC19	—	SC19	SC19	SC19	—
Slate	SC8	SC8	—	SC8	—	SC8	SC8	—	SC8	SC8	—	SC8	SC8	SC8	SC8
Sterling	—	SC18	—	SC18	—	SC18	SC18	—	SC18	SC18	—	SC18	SC18	SC18	—
Tangerine	—	SC23	—	—	—	—	SC23	—	—	—	—	SC23	SC23	—	—
White	—	—	SC26	—	SC26	—	—	SC26	—	—	SC26	—	—	—	—

Plastic

Color	Code	
Apple	SC24	
Arctic	SC21	
Black	SC1	
Bisque	SC7	
Chocolate	SC4	
Fog	SC27	

Plastic (Cont.)

Color	Code	
Lagoon	SC15	
Latte	SC20	
Lemon	SC25	
Navy	SC5	
Pacific	SC22	
Red	SC19	

Plastic (Cont.)

Color	Code	
Slate	SC8	
Sterling	SC18	
Tangerine	SC23	
White	SC26	

MESH COLOR PROGRAM











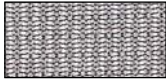
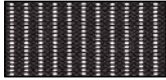

The following collections are available in the mesh color program: Amplify, Focus, Focus 2.0, Focus Side, Mavic, Movi, Novo, Qwiz, Torsa, Vectra, Wit and Wit Side. No minimum orders or additional costs apply.

Mesh











	Amplify	Flytech	Focus	Focus 2.0	Focus Side	Hexy	Mavic	Movi	Novo	Qwiz	Torsa	Vectra	Wit	Wit Side
Solids														
Apple	MC31	MC31	—	MC31	MC31	MC31	MC31	MC31	MC31	MC31	—	—	MC31	MC31
Aqua	MC30	MC30	—	—	MC30	—	—	MC30	MC30	MC30	—	—	MC30	MC30
Ash	—	—	—	MC45	—	—	—	—	—	—	—	—	—	—
Black	—	—	MC1	MC1	MC1	—	—	—	—	—	—	—	—	—
Charcoal	—	—	—	MC44	—	—	—	—	—	—	—	—	—	—
Desert	MC9	MC22	—	MC9	MC9	MC22	MC9	MC22	MC22	MC22	MC9	MC9	MC22	MC22
Dune	—	—	—	MC46	—	—	—	—	—	—	—	—	—	—
Electric Blue	MC24	MC24	—	MC13	MC24	MC24	MC13	MC24	MC24	MC24	—	—	MC24	MC24
Fire	MC10	MC25	—	MC10	MC10	MC25	MC10	MC25	MC25	MC25	MC10	—	MC25	MC25
Fog	MC7	MC23	—	MC7	MC7	MC23	MC7	MC23	MC23	MC23	MC7	—	MC23	MC23
Grape	—	MC26	—	—	—	—	—	MC26	MC26	MC26	—	—	MC26	MC26
Lemon	—	MC27	—	—	—	—	—	MC27	MC27	MC27	—	—	MC27	MC27
Midnight	—	—	—	MC43	—	—	—	—	—	—	—	—	—	—
Mist	—	—	—	—	—	—	—	—	—	—	—	MC41	—	—
Navy	MC8	—	—	MC8	MC8	MC8	MC8	—	—	—	MC8	MC8	—	—
Nickel	MC6	MC21	—	MC6	MC6	MC21	MC6	MC21	MC21	MC21	MC6	MC6	MC21	MC21
Ocean	—	MC29	—	MC29	—	MC29	MC29	MC29	MC29	MC29	—	—	MC29	MC29
Onyx	MC5	MC20	—	MC5	MC5	MC20	MC5	MC20	MC20	MC20	MC5	MC5	MC20	MC20
Platinum	—	—	—	—	—	—	—	—	—	—	—	MC42	—	—
Slate	—	—	MC2	MC2	MC2	—	—	—	—	—	—	—	—	—
Sand	—	—	MC3	MC3	MC3	—	—	—	—	—	—	—	—	—
Tangerine	MC28	MC28	—	MC28	MC28	MC28	MC28	MC28	MC28	MC28	—	—	MC28	MC28
Stripes														
Desert Stripe	—	—	—	—	—	—	—	—	—	—	MC16	—	—	—
Fog Stripe	—	—	—	—	—	—	—	—	—	—	MC15	—	—	—
Fog Woven Stripe	—	—	—	—	—	—	—	—	—	—	—	—	MC37	—
Freeway	—	—	MC33	MC33	MC33	—	—	—	—	—	—	—	—	—
Frost Woven Stripe	—	—	—	—	—	—	—	—	—	—	—	—	MC36	—
Impress	—	—	MC34	MC34	MC34	—	—	—	—	—	—	—	—	—
Nickel Woven Stripe	—	—	—	—	—	—	—	—	—	—	—	—	MC38	—
Onyx Stripe	—	—	—	—	—	—	—	—	—	—	MC14	—	—	—
Onyx Woven Stripe	—	—	—	—	—	—	—	—	—	—	—	—	MC35	—

MESH COLOR PROGRAM







Mesh

Mesh Color	Code	
Solids		
Apple	MC31	
Aqua	MC30	
Ash	MC45	
Black	MC1	
Charcoal	MC44	
Desert	MC9/ MC22	
Dune	MC46	
Electric Blue	MC13/ MC24	
Focus 2.0 Electric Blue	MC13	
Fire	MC10/ MC25	
Fog	MC7/ MC23	
Grape	MC26	
Lemon	MC27	

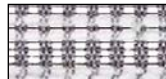
Mesh (Cont.)

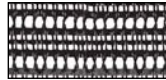
Mesh Color	Code	
Solids		
Midnight	MC43	
Mist	MC41	
Navy	MC8	
Nickel	MC6/ MC21	
Ocean	MC5/ MC20	
Onyx	MC20	
Platinum	MC42	
Slate	MC2	
Sand	MC3	
Tangerine	MC28	

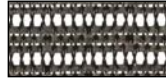
Mesh (Cont.)

Mesh Color	Code	
Stripes		
Desert Stripe	MC16	
Fog Stripe	MC15	
Fog Woven Striped	MC37	
Freeway	MC33	
Frost Woven Stripe	MC36	
Impress	MC34	
Onyx Stripe	MC35	
Onyx Woven Striped	MC35	

MULTIPURPOSE CHAIR OPTIONS

		ACHIEVE	ANYTIME	BAJA	CORA	FLYTECH	FOCUS SIDE	FREELANCE	FREELANCE BARIATRIC	INFLEX	IONIQ SIDE	LUMIN	MIKA	MOVI	ORBIX	QWIZ	RELAY	RIO	ROWDY	SPROUT	WIT SIDE	
BACK OPTIONS	Ballistic Nylon Back																					
	Mesh Back																					
	Plastic Back																					
	Upholstered Back																					
	Wood Back																					
SEAT OPTIONS	Plastic Seat																					
	Upholstered Seat																					
	+1" Seat Foam																					
HD SERIES	Heavy Duty (350 lb)																					
	Bariatric (500 lb)																					
	Bariatric (600 lb)																					
	Bariatric (750 lb)																					
	Bariatric (1000 lb)																					
FRAME OPTIONS	4-Leg																					
	Wire Rod/Sled																					
	Nester																					
	Black																					
	Chrome																					
	Fog																					
	Polished Aluminum																					
	Silver																					
White																						
OTHER	Ganging Bracket																					
	Stacking Cart																					
ARM OPTIONS	Armless																					
	Fixed																					
	Fixed Loop																					
	Tablet Arm																					

MULTIPURPOSE STOOL OPTIONS

		ANYTIME	BAJA	FOCUS SIDE	FREELANCE	INFLEX	LUMIN	MIKA	RIO
BACK OPTIONS	Ballistic Nylon Back								
	Mesh Back								
	Plastic Back								
	Upholstered Back								
	Wood Back								
SEAT OPTIONS	Plastic Seat								
	Upholstered Seat								
	+1" Seat Foam								
FRAME OPTIONS	Bar Stool								
	Counter Stool								
	4-Leg								
	Wire Rod/Sled								
	Black								
	Chrome								
	Fog								
	Polished Aluminum								
	Silver								
ARM OPTIONS	Armless								
	Fixed								
	Fixed Loop								