

SitOnIt • Seating®

Tables, Benching and Power Beams Price List

October 17, 2022



TABLE OF CONTENTS

Intro

Sustainable Design.....	4
Warranty	5
Ordering Information	8
Custom Finish Program.....	12

Mezzanine

End Table, Coffee Table and Corner Table.....	20
Occasional Table	23

Ocala

Flip-Top Tables	26
Typicals	30

Parallon

Flip-Top and Fixed Top Training Table.....	34
Meeting, Café and Occasional Table	41

Surge

2-Leg Height-Adjustable Table.....	46
------------------------------------	----

Switchback

2-Leg Height-Adjustable Table Bundle	50
2-Leg Height-Adjustable Table.....	56
3-Leg Height-Adjustable Table Typical.....	61
3-Leg Height-Adjustable Table.....	64

Tensor

Café, Classroom, and Office Typical.....	75
Café Table	78
Multipurpose Table.....	82
Desking	86

Uni

Laptop Table	96
--------------------	----

Benching

HiQ

Height-Adjustable Benching	99
----------------------------------	----

Prise

Benching Typical.....	111
Benching	116

Power Beam

EBEAM

Power + Data Beam	129
-------------------------	-----

Appendix

Stand-Alone Tabletops.....	137
Laminate Color Program	144
Care and Cleaning.....	147

SitOnIt • Seating®

CALIFORNIA BORN AND BRED

We're a leading manufacturer of commercial solutions in the U.S.—and #1 in task chairs. From tables and lounge to screens and more, we've been the go-to destination for comprehensive, build-to-order solutions for almost 25 years.

We combine award-winning design with the fastest lead times around (choose from 2-, 5- or 10-day shipping). We can build almost any specification you want, deliver it when you need it and offer a price no one can match. It's all part of our indie California spirit and drive to help you do more.

DESIGN THAT GETS YOU

Discover seating engineered around you. Experience responsive design, supreme comfort and hyper-customizable features—all at value-driven prices.

OUR BUILD-TO-ORDER PROMISE

Custom-designed chairs, no waiting. Our nimble size and lean manufacturing operation means we can ship build-to-order chairs in just two days.

FASTEST SHIPPING IN THE INDUSTRY

Choose from two, five, or 10 day shipping. We cut lead time, sync orders and avoid off-schedule shipments at a rate our competitors just can't match.

WORLD-CLASS SERVICE

We're proud to announce that the Office Furniture Dealer Alliance voted for us as "Best Customer Service" three times in the past five years.

SUSTAINABLE DESIGN

We make it easy to go green. Design an eco-friendly room from the ground up or upgrade an existing space to meet the latest environmental standards.



ANSI/BIFMA Certified

SitOnIt Seating is a member of the Business and Institutional Furniture Manufacturer's Association (BIFMA). Tests developed by BIFMA are approved by the American National Standards Institute (ANSI) to determine the strength and durability of seating. Although testing is not a warranty or guarantee, our task, side and lounge products meet or exceed BIFMA and ANSI standards.



LEED Certified

Earn points toward LEED certification thanks to our U.S. manufacturing location and our use of recycled materials where possible.



GREENGUARD Certification

All SitOnIt Seating lounge and seating products met the rigorous criteria required by GREENGUARD in accordance with the Collaborative for High Performance Schools.



LEVEL Certified

Sustainability matters. That's why we've worked to achieve BIFMA LEVEL® certification for all task chairs, side chairs and lounge products.



The Take Back Program

SitOnIt Seating helps minimize product waste by connecting our customers and dealers with third-party groups who redirect materials that would be headed for the landfill to local nonprofits and public agencies.



We Did Our Homework

Download detailed documents that break down the percentage of recycled content, manufacturing processes and indoor air emissions for every chair we make.

WARRANTY

Product Warranty Periods

Exemplis LLC, d.b.a. SitOnIt Seating (hereafter referred to as the Company), warrants to the original end user that this product will be free from defects in its material and workmanship when used in a single shift (standard eight-hour day, five days per week) for the following warranty periods:

LIFETIME WARRANTY COVERAGE:

- All SitOnIt Seating products, except where noted below
- Structural Components: eBEAM, HiQ, Parallon, Prise, Surge, Switchback and Voyager

12-YEAR WARRANTY COVERAGE:

- Amplify, Cora (Guest, Hip and Stool), Novo, Torsa, and Wit used in multi-shift (24/7) applications
- Lounge seating and occasional/lounge tables
- Bases: Ocala, Tensor
- Laminate tops
- Monitor arms¹: King Cobra, Mobio series, Unity G2
- Plastic shells

10-YEAR WARRANTY COVERAGE:

- Non-Stop Heavy Duty, Cora (Midsize and Bariatric), Freelance Bariatric and chairs purchased with a Heavy Duty (HD) or Large and Tall (LT) option used in multi-shift (24/7) applications
- Electrical Components: eBEAM, HiQ, Parallon, Prise, Surge and Switchback

FIVE-YEAR WARRANTY COVERAGE:

- Fabric, foam, knit back, and mesh
- All filing products³
- CPU holders
- Screens⁴
- High Tide
- Keyboard trays
- Lighting fixtures
- Power components⁵: EON, Current, Power Strips
- Wire management

TWO-YEAR WARRANTY COVERAGE:

- Fabric and foam cushioning for Non-Stop Heavy Duty, Freelance Heavy Duty, Cora Midsize and Bariatric and chairs purchased with an HD or LT option
- Multipurpose felt glides
- Half-Moon Pencil Drawer

ONE-YEAR WARRANTY COVERAGE:

- Lighting power supplies
- Mouse pads
- Wrist rests

1. Weight capacity of the monitor arms must be followed. If an arm is not functioning properly because of the weight of the monitor is outside of the advertised weight capacity, the monitor arm will not be considered defective under the warranty.

2. Please note that electrical components on a height-adjustable table include: hand controls, motors, control boxes and electrical cables.

3. This warranty does not cover damage from ordinary wear and tear, including paint finish changes and/or discoloration resulting from aging or exposure to light.

4. Warranty limited to finishes, tacking surface of tack boards and writing surface of whiteboards. Standard textiles limited to original manufacturer's warranty.

5. Power components are defined as any power unit with electrical outlets and/or USB/data connections, connector jumper cables for daisy chain and infeeds for hardwire applications.

WARRANTY

Freight Warranty

At SitOnIt Seating™, we take pride in crafting one-of-a-kind pieces. Products are thoughtfully inspected prior to being carefully wrapped and packed for shipment. Upon receiving your order, should your order be less than perfect, please follow these steps for an expedited resolution:

IF DAMAGE IS VISIBLE:

- Please accept shipment and report damages on the freight bill.
- Contact SitOnIt Seating Customer Experience to report the issue **within 10 days** after delivery.

IF DAMAGE IS CONCEALED:

- Save merchandise and packaging.
- Take a photo to document the damage.
- Contact SitOnIt Seating Customer Experience to report the issue **within 60 days** after delivery.

Either way, we are here to help! SitOnIt Seating Customer Experience Team is on standby to assist Monday through Friday, 5:00 a.m. to 5:00 p.m. PST. Call (888) 274-8664 or email sitonit@exemplis.com.

The Company Does Not Warranty

- COM/COL textiles
- Product abuse or misuse
- Failure resulting from normal wear and tear
- User modification of or attachments to the product
- Products or parts not used, maintained or installed in accordance with the Company's installation, maintenance and/or applicable guidelines
- Products that are exposed to extreme environmental conditions and/or have been subject to improper storage
- Floor samples or display models
- The substitution or use of non-SitOnIt Seating components with SitOnIt Seating products
- Products purchased "as is" and/or secondhand
- Products sold by unauthorized dealers
- Creasing and/or gathering of textiles during upholstery application process
- Minor irregularities of color, surface, grain and texture
- Minor variations of color in textiles
- Variations of texture and natural markings such as neck wrinkles, scratches, backbone marks and stretch marks in leather
- Color matching of textiles exactly to samples, swatches or prior purchases

For orders shipping outside the contiguous 48 U.S. states or the common provinces of Canada (British Columbia, Alberta, Saskatchewan, Manitoba, Ontario, Quebec, New Brunswick & Nova Scotia), we will provide replacement parts and pre-approved labor as determined by our warranty team. However, matching our standard freight policy, we will only ship those replacement parts to a U.S. port. It is up to our dealer to handle freight costs from the U.S. port to their location.

WARRANTY

Applicable Provisions To All Products And Services

The Company will repair or replace with a comparable product, at its option, without charge to the original purchaser, only defective products or parts found defective during the Warranty Period. If requested by the Company, the original purchaser must return the part or product with freight or other shipping charges prepaid.

This warranty shall be effective for the applicable time period beginning from date of purchase as shown on original purchaser's original receipt or other proof of purchase.

For products purchased on or after August 1, 2012, the Company shall pay for all labor costs pre-approved by the Company. The payment of such pre-approved labor costs will be in the form of a credit to an active Company account.

There are no other warranties, expressed or implied, other than those specifically described, including, without limitations, any implied warranty or merchantability or of fitness for a particular purpose. The Company will not be responsible for incidental or consequential damages. Some states do not allow the exclusion or limitation of incidental or consequential damages, so the above limitations or exclusions may not apply to you. This warranty gives you specific legal rights and you may have other rights which vary from state to state.

Warranty claims must be reported within 60 days of any concealed damage. The Company will advise you of the procedure to follow when making warranty claims. Call the Company at the number below to explain the defect. Give your name, address and telephone number. Please be prepared with the model number and sales order number found under the seat of the chair.

SitOnIt Seating: (888) 274-8664

ORDERING INFORMATION

Pricing

All prices are suggested retail and are subject to change without notice. Visit our websites or contact Customer Experience for the latest pricing. Prices in effect at the time of shipment will prevail. We reserve the right to make changes in prices, models, fabrics, finishes, materials and specifications and also discontinue models and options at any time without notice.

Orders

Specify model number, quantity, desired delivery date and all other applicable information. Order templates can be found in the applicable Price Guide. Orders will be accepted with an acknowledgment form governing the transaction. In the event an error is made in the manufacture of the product, the acknowledgment will be used as the resolution document. Submit orders by email or fax:

SITONIT SEATING:

Email: purchaseorder@exemplis.com

Fax: (714) 995-4855

Minimums

FREIGHT PROGRAM

The freight program is designed to deliver freight prepaid to the designated consignee. To offset rapidly increasing costs, it requires a minimum quantity (three or more items) for select product categories. Premium freight services and/or guaranteed delivery may result in additional shipping charges.

NO MINIMUM REQUIREMENT:

- Task/Collaborative/Conference/Executive seating and task stools
- Side, nesting seating and stools
- Plastic seating
- Height adjustable tables (except tops)*
- Fixed and adjustable benches (except tops)*
- Power beam
- Training/meeting/Café/Occasional tables (except tops)*
- Ergonomic accessories (e.g. monitor arms, keyboard trays, wire management, desktop sit-to-stand, anti fatigue mats, power solutions)
- Screens
- Storage
- WFH products

Note: The tops for these products will have a minimum requirement of four units. Uni table ships in a single packet and the top is not subject to minimum four rule.

Minimums (Cont.)

3-UNIT MINIMUM:

- Lounge seating
- Tandem seating (Aviera)

Note: Products that do not require a minimum can be combined with those that require 3-unit minimum to reach the minimum quantity. If the minimum is not met, the order will incur a \$95 net surcharge per order.

4-UNIT MINIMUM:

- Tabletops/worksurfaces

Note: Tabletop/worksurface orders that don't reach the minimum of 4 tops will incur a \$95 net surcharge per order even if they're part of a larger order.

EXAMPLES

- Order A: 1 Rio chair, 1 Wit chair, 1 Gobi – no surcharge
- Order B: 1 Gobi, 1 Envoi - \$95 surcharge because the number of lounges is less than minimum 3 and there are no other products in the order
- Order C: 1 Aviera, 1 Mobio arm, 1 Motif screen – no surcharge
- Order D: 1 eBeam, 1 EON, 1 Switchback base, 1 Switchback top - \$95 surcharge because the number of tops is under the required four tops minimum
- Order E: 3 Switchback tables with tops - \$95 surcharge because the number of tops is under the required four tops minimum

Quantity Discounts

Quantity discounts for CAL 133 textiles and some shipping methods are available. See the appropriate Price Guide or contact Customer Experience for more information.

Change Orders

Orders that have been scheduled for production may not be changed. All changes on customer orders previously acknowledged must be requested in writing and are subject to approval. Requests for changes are not deemed accepted until acknowledged. In the event a revision is accepted, change fees may apply.

ORDERING INFORMATION

Lead Time

We have thousands of carded textiles—including vinyl and leather—that ship in two, five or 10 days. For a complete listing of textile lead times, see the Carded Textile Program section of the [Textile Reference Guide](#) or visit the [Materials tab](#) on our websites. Graded-in, COM and COL orders start production when the textile arrives from the manufacturer. Because of this the lead time on Motif screens or upholstered chairs is two, five or 10 days based on the textile selection.

TWO-DAY

- Anti-Fatigue Mat
- Corner Sleeve
- CPU Holders
- Current power
- High Tide
- Keyboard Mechanisms (Lift and Lock, Premium Lift and Lock, Sit-to-Stand)
- Keyboard Trays (Longboard, Crescent Board, Mini Platform, Laptop Tray, Adapter)
- Laptop Drawer
- Mobile Pedestals
- Monitor Arms
- Ocala Bases
- Pencil Storage
- Plastic Shells
- Switchback Bases
- Tensor Bases
- Value Lighting
- Voyager 2-Stage/3-Leg Bases
- Wire Management

THREE-DAY

- Doodle Screens
- Mobile Pedestal Cushions
- Modesty Screens
- Motif Screens
- Parallon Tables
- Prise Benching
- Sector Screens
- Standard Worksurfaces

10-DAY

- Lounge

15-DAY

- Stain-to-Match

21-DAY

- Tablet Arm

30-DAY

- Custom Laminate

Hold

Orders received by 10 a.m. PST begin assembly the next day. Orders that are “On Hold” will begin production only when all holds are released. Customer Experience will notify you of any holds placed on your order.

Types of holds include:

- Credit Hold for issues related to billing and invoicing.
- Incomplete Hold if the purchase order is incomplete or illegible.
- Pricing Hold if the price on the purchase order does not match the pricing shown in the Price Guide or in our computer system.
- New Fabric Hold for nonstandard textile orders without an inventory part number.
- Graded Hold is placed by the Purchasing Department while confirming delivery of graded fabric from the vendor.

Large Orders

Large orders may require additional lead time:

25 UNITS

- Cameo
- Composium
- Envoi
- Gobi
- Nano
- Paséa
- Visit Modular

50 UNITS

- Aviera
- Benching
- Screens
- Surge Bases
- Tabletops
- Tensor Bases
- Parallon Bases

150 UNITS

- Accessories
- Switchback Bases
- Lighting
- Monitor Arms
- Ocala Bases
- Power
- Sit-Stand (Desktop)

250 UNITS

- Task Chairs/Stools
- Side Chairs/Stools

ORDERING INFORMATION

Product Modification

Special requests are available and additional charges will be determined per quotation. Up to five working days are required after the special request is received to prepare a quotation. Contact Customer Experience for details.

Orders for Parts

Multiple shipments may occur for orders that include parts. Hardware such as casters or cylinders will ship separately from items requiring upholstery or manufacturing labor. Components such as casters or cylinders will ship separately from new chairs.

Product and Design Changes

We reserve the right to discontinue product lines, models and parts at any time. We also reserve the right to make changes in design and material when such action is deemed to be an improvement in design, function and/or construction.

Cancellation and Returns

Orders that have entered any stage of production cannot be canceled. Request for cancellations are not accepted until acknowledged. In the event a cancellation is accepted, canceled charges may be imposed for the entire amount of the order. Authorization for return must be requested from and approved by Customer Experience prior to the return of the merchandise. Returns may be subject to a restocking charge equivalent to 40% of the net order plus freight. Unauthorized returns will not be accepted.

Shipping

Standard shipments are made via common carrier, unless otherwise specified. Special routing requests made by the customer or the consignee may result in additional charges.

Standard deliveries are dock-to-dock and are scheduled to occur Monday through Friday between 8 a.m. and 5 p.m., based on our published transit times. We will not be held responsible for issues or costs arising from carrier transit delays, missed delivery appointments, etc.

We reserve the right to charge for nonstandard customer delivery requirements that may include order deliveries, inside deliveries, etc. For information concerning these charges, contact Customer Experience.

Freight Terms

Freight terms apply to the continental U.S. only. This excludes Alaska and Hawaii. All standard transportation services and freight costs are included in the price of our products. We ship freight prepaid and allowed, FOB and origin.

Shipments outside the contiguous U.S. are shipped to the point of embarkation free of charge, if the shipment meets the minimum requirement. All subsequent freight charges will be at the customer's expense, shipped collect.

Because of the fluctuation of fuel prices, we reserve the right to impose fuel surcharges for any shipments.

Freight Damage

We are not responsible for product damage occurring in transit or during storage. Before accepting a shipment from the carrier, carefully review the packing list and inspect the quantity and condition of the items. Promptly document all visible damage on the Bill of Lading and request a carrier inspection of the product. In the event of damage, accept the order and contact Customer Experience for issue resolution. Concealed damage must be reported in writing within 60 days of accepting delivery. We will take all reasonable steps to assist customers in resolving claims for loss or damage.

Smart Delivery

Smart Delivery provides precise order delivery within a customer-specified date and time window. This special service is available in the contiguous U.S. and includes inside delivery, non-dock delivery, weekend delivery and residential delivery.

Requests must be made prior to an order being scheduled for production. A Smart Delivery fee will be added to the original order invoice. Any changes to a submitted Smart Delivery order will require a new Smart Delivery quote request. Not all change requests can be honored. Changes to an order will result in delays and/or additional costs once the order is in transit.

The Smart Delivery fee will be refunded if the shipment does not arrive within the specified delivery window. We will not be held responsible for costs or damages associated with delayed deliveries.

Please contact Customer Experience to request a Smart Delivery quote or for more information.

Will Call

Customers with Will Call orders will be notified once orders are ready to be picked up. Customers will have three business days from notification to pick up the order. If the order is not picked up within this time frame, storage charges will start at a rate of \$30 per business day until the order has been claimed.

Invoicing

Invoicing is triggered when the product ships.

CUSTOM FINISH PROGRAM

Pricing

First-time custom stains must be approved before acceptance of an order. A one-time net fee applies if stains are not in our library. Thereafter, a stain-to-match upcharge is applied to each chair.

LOUNGE

Stain not in our library: \$275 Net
Stain-to-match upcharge: \$70 List

Ordering

When ordering, enter the approved STAIN ID# in the Material section of the Final Price Calculation worksheet or on your purchase order.

Custom Finish Terms and Conditions

Wood is inherently beautiful because of natural variations in color, grain and texture. There may be minor differences from one chair to the next, even though they are finished at the same time. We cannot guarantee exact matches of grain or natural wood color.

Approval Process

Since all new stains must be approved before they can be applied to seating or tables, allow extra time for custom finishes. Custom finishes generally require at least one to two weeks to create a matched sample. We will need a signed Approval Form before we can accept your order. We reserve the right to decline the opportunity to match a finish color.

1. Send a 3" x 4" or 4" x 6" sample of the stain, along with the model numbers and options to which the finish will be applied, to:

Customer Experience
Custom Finish Program
6415 Katella Avenue
Cypress, CA 90630

Include dealer name, contact and project reference.

2. Once approved, we will send a finish sample to you along with any caveats that may apply. We will keep an identical sample in our files for future orders. Custom finishes generally require at least a week to create a matched sample.
3. Carefully review the sample. Note the STAIN ID# (example: SM#070214-1); this will be needed for your order. Return the signed approval form to Customer Experience along with your order. We need your approval before we can accept the order, schedule it for production or acknowledge a ship date.
4. Lounge orders using our stain-to-match program will have a lead time of 15 days.

Tables and Desks

COFFEE TABLE | END TABLE
HEIGHT-ADJUSTABLE TABLE
MULTIPURPOSE TABLE
DESK AND RETURN

Statement of Line

COFFEE TABLE | END TABLE | CAFÉ TABLE | MULTIPURPOSE TABLE
HEIGHT-ADJUSTABLE TABLE | DESK AND RETURN

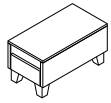

Mezzanine

Cube End Table
Plastic/Wood Tapered Square Feet
MCM TT1 LS1/LS12
Page 20

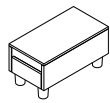

Mezzanine

Cube End Table
Tapered Cylinder Feet
MCM TT1 LS11
Page 20

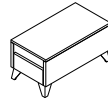

Mezzanine

Cube End Table
Angular Feet
MCM TT1 LS6
Page 20

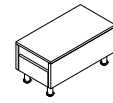

Mezzanine

Cube End Table
Pole Feet
MCM TT1 LS7/LS8
Page 20

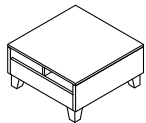

Mezzanine

Cube Coffee Table
Plastic/Wood Tapered Square Feet
MCM TT2 LS1/LS12
Page 20

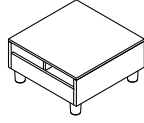

Mezzanine

Cube Coffee Table
Tapered Cylinder Feet
MCM TT2 LS11
Page 20

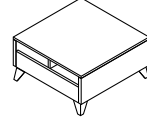

Mezzanine

Cube Coffee Table
Angular Feet
MCM TT2 LS6
Page 20

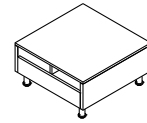

Mezzanine

Cube Coffee Table
Pole Feet
MCM TT2 LS7/LS8
Page 20

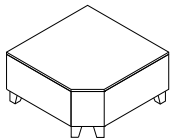

Mezzanine

Cube Corner Table
Plastic/Wood Tapered Square Feet
MCM TT3 LS1/LS12
Page 20

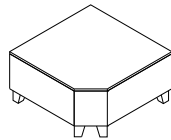

Mezzanine

Cube Corner Table
Tapered Cylinder Feet
MCM TT3 LS1/LS12
Page 20

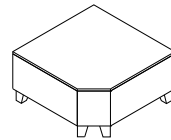

Mezzanine

Cube Corner Table
Angular Feet
MCM TT3 LS6
Page 20

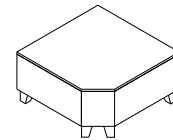

Mezzanine

Cube Corner Table
Pole Feet
MCM LS7/LS8
Page 20

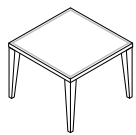

Mezzanine

Square Occasional Table
Wood Tapered Square Legs
MZM TT8 LSL2
Page 23

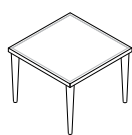

Mezzanine

Square Occasional Table
Wood Tapered Cylinder Legs
MZM TT8 LSL3
Page 23

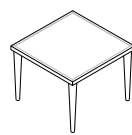

Mezzanine

Square Occasional Table
Pole Legs
MZM TT8 LSL1
Page 23

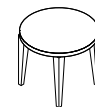

Mezzanine

Round Occasional Table
Wood Tapered Square Legs
MZM TT6 LSL2
Page 23

Statement of Line

COFFEE TABLE | END TABLE | CAFÉ TABLE | MULTIPURPOSE TABLE
HEIGHT-ADJUSTABLE TABLE | DESK AND RETURN



Mezzanine

Round Occasional Table
Wood Tapered Cylinder Legs
MZM TT6 LSL3
Page 23

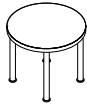

Mezzanine

Round Occasional Table
Pole Legs
MZM TT6 LSL1
Page 23

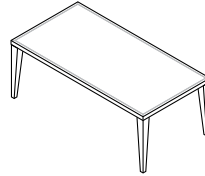

Mezzanine

Rectangular Occasional Table
Wood Tapered Square Legs
MZM TT5 LSL2
Page 23

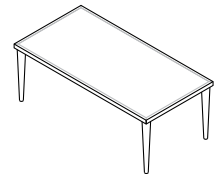

Mezzanine

Rectangular Occasional Table
Wood Tapered Cylinder Legs
MZM TT5 LSL3
Page 23

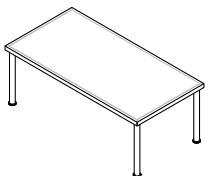

Mezzanine

Rectangular Occasional Table
Pole Legs
MZM TT5 LSL1
Page 23

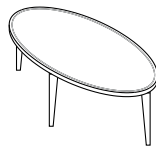

Mezzanine

Oval Occasional Table
Wood Tapered Square Legs
MZM TT4 LSL2
Page 23

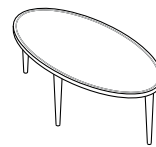

Mezzanine

Oval Occasional Table
Wood Tapered Cylinder Legs
MZM TT5 LSL3
Page 23

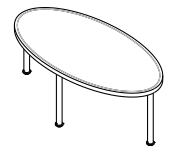

Mezzanine

Pole Legs
Wood Tapered Square Legs
MZM TT5 LSL1
Page 23

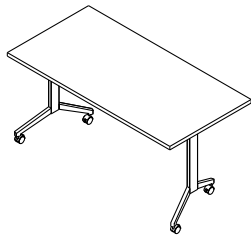

Ocala

Rectangular Top
Flip-Top Base
3061 TBT2
Page 26

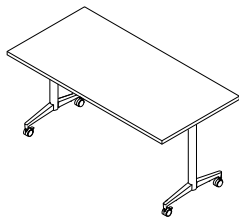

Parallon Training

Rectangular Tabletop
Fixed/Flip-Top T-Leg Base
3271/3272 TZ TBT2/TBT3
Page 34

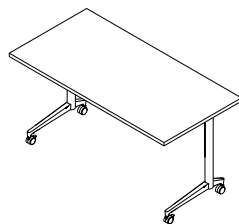

Parallon Training

Rectangular Tabletop
Fixed C-Leg Base
3271/3272 TZ TBT3C
Page 34

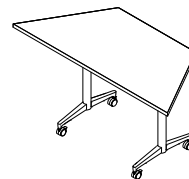

Parallon Training

Trapezoid Tabletop
Fixed/Flip-Top T-Leg Base
3271/3272 TPZ TBT2/TBT3
Page 34

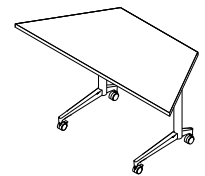

Parallon Training

Trapezoid Tabletop
Fixed C-Leg Base
3271/3272 TPZ TBT3C
Page 34

Statement of Line



Parallon Training

Half-Round Tabletop
Fixed/Flip-Top T-Leg Base
3271/3272 THR TBT2/TBT3
Page 34

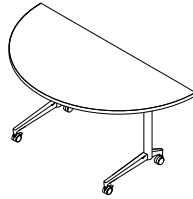

Parallon Training

Half-Round Tabletop
Fixed C-Leg Base
3271/3272 THR TBT3C
Page 34

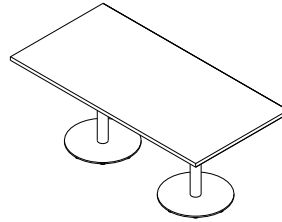

Parallon Meeting

Rectangular Tabletop
Standard-Height Dual-Disc Base
3271/3272 THR TBT2/TBT3
Page 41

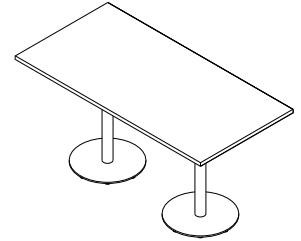

Parallon Meeting

Rectangular Tabletop
Counter-Height Dual-Disc Base
3271/3272 THR TBT2/TBT3
Page 41

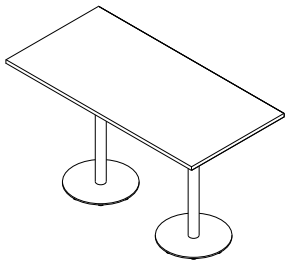

Parallon Meeting

Rectangular Tabletop
Bar-Height Dual-Disc Base
3271/3272 THR TBT2/TBT3
Page 41

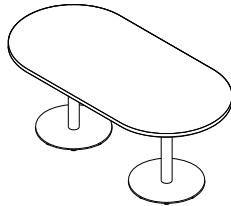

Parallon Meeting

Racetrack Tabletop
Standard-Height Dual-Disc Base
3271/3272 THR TBT2/TBT3
Page 41

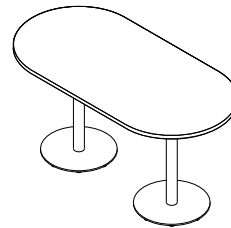

Parallon Meeting

Racetrack Tabletop
Counter-Height Dual-Disc Base
3271/3272 THR TBT2/TBT3
Page 41

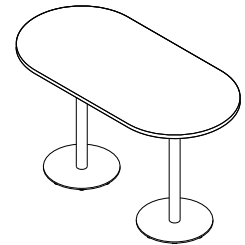

Parallon Meeting

Racetrack Tabletop
Bar-Height Dual-Disc Base
3271/3272 THR TBT2/TBT3
Page 41



Parallon Café

Square Tabletop
Occasional X-Base
3271/3272 TS TBT4 TH16/TH20
Page 41

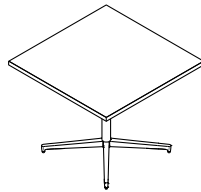

Parallon Café

Square Tabletop
Standard-Height X-Base
3271/3272 TS TBT4/TBT4P TH29
Page 41

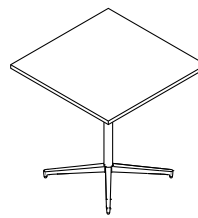

Parallon Café

Square Tabletop
Counter-Height X-Base
3271/3272 TS TBT4/TBT4P TH36
Page 41

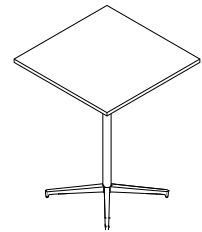

Parallon Café

Square Tabletop
Bar-Height X-Base
3271/3272 TS TBT4/TBT4P TH42
Page 41

Statement of Line

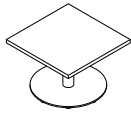

Parallon Café

Square Tabletop
Occasional Disc-Base
3271/3272 TS TBT16/TBT16P TH16/TH20
Page 41

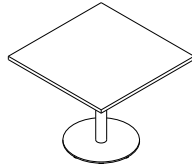

Parallon Café

Square Tabletop
Standard-Height Disc-Base
3271/3272 TS TBT15/TBT15P TH29
Page 41

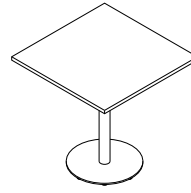

Parallon Café

Square Tabletop
Counter-Height X-Base
3271/3272 TS TBT15/TBT15P TH36
Page 41

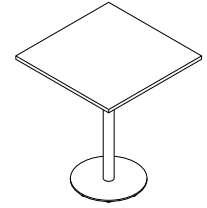

Parallon Café

Square Tabletop
Bar-Height Disc-Base
3271/3272 TS TBT15/TBT15P TH42
Page 41



Parallon Café

Round Tabletop
Occasional X-Base
3271/3272 TR TBT4 TH16/TH20
Page 41



Parallon Café

Round Tabletop
Standard-Height X-Base
3271/3272 TR TBT4/TBT4P TH29
Page 41



Parallon Café

Round Tabletop
Counter-Height X-Base
3271/3272 TR TBT4/TBT4P TH36
Page 41

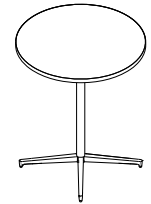

Parallon Café

Round Tabletop
Bar-Height X-Base
3271/3272 TR TBT4/TBT4P TH42
Page 41

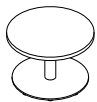

Parallon Café

Round Tabletop
Occasional Disc-Base
3271/3272 TR TBT16/TBT16P TH16/TH20
Page 41

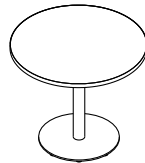

Parallon Café

Round Tabletop
Occasional Disc-Base
3271/3272 TR TBT16/TBT16P TH29
Page 41

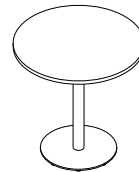

Parallon Café

Round Tabletop
Occasional Disc-Base
3271/3272 TR TBT16/TBT16P TH36
Page 41

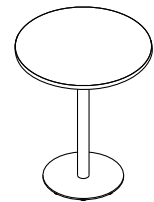

Parallon Café

Round Tabletop
Occasional Disc-Base
3271/3272 TR TBT16/TBT16P TH42
Page 41

Statement of Line

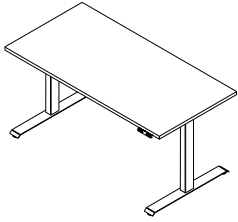

Surge

Rectangular Tabletop
2-Leg T-Leg
3301/3302 TZ TBT6
Page 46

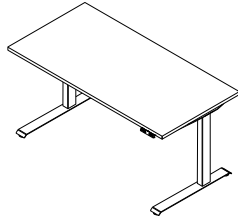

Surge

Rectangular Tabletop
2-Leg C-Leg
3301/3302 TZ TBT6C
Page 46

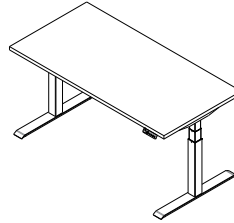

Switchback

Rectangular Tabletop
2-Leg T-Leg
3161/3162 TZ TBT6/TBT7
Page 56

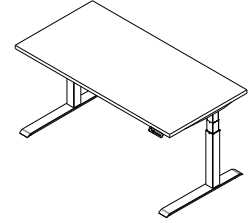

Switchback

Rectangular Tabletop
2-Leg C-Leg
3161/3162 TZ TBT6C/TBT7C
Page 56

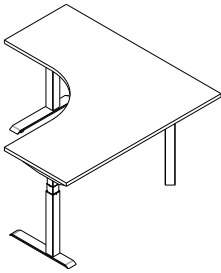

Switchback

90-Degree Tabletop
3-Leg C-Leg
3161/3162 TA
Page 64

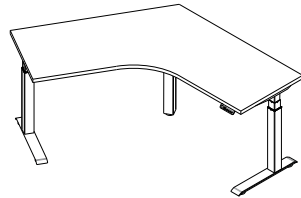

Switchback

120-Degree Tabletop
3-Leg C-Leg
3161/3162 TA
Page 64

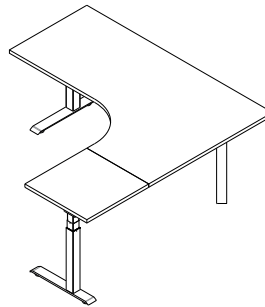

Switchback

Extended Left Corner
3-Leg C-Leg
3161/3162 OL
Page 78

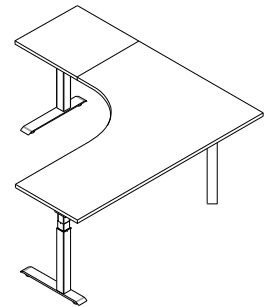

Switchback

Extended Right Corner With Return
3-Leg C-Leg
3161/3162 TXR
Page 64

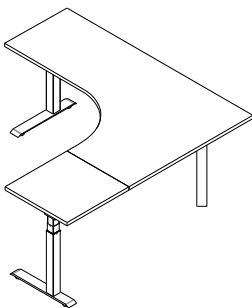

Switchback

Extended Left Corner With Return
3-Leg C-Leg
3161/3162 TXL
Page 64

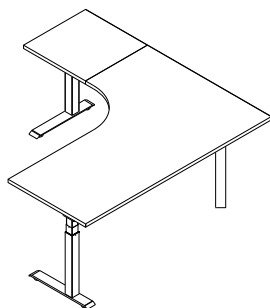

Switchback

Extended Right Corner
3-Leg C-Leg
3161/3162 OR
Page 64

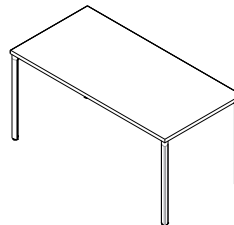

Tensor Multipurpose

Extended Left Corner With Return
3-Leg C-Leg
3231/3232 TBT9 TZ
Page 82

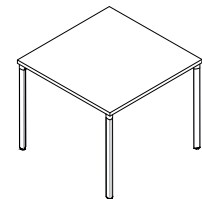

Tensor Café

Square Tabletop
3231/3232 TBT9 TS
Page 78

Statement of Line

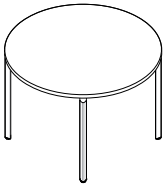

Tensor Café

Round Tabletop
3231/3232 TBT9 TR
[Page 78](#)



Uni

Laptop Table
3260 TT9
[Page 96](#)

Mezzanine

END TABLE, COFFEE TABLE AND CORNER TABLE

Get in top shape.

Mezzanine® tables are available in two popular styles—cube and occasional. From the modernist cube to the transitional occasional style, these accent pieces are designed to complement any SitOnIt Seating chair, settee or sofa. Built with the highest quality veneers and hardwoods, Mezzanine tables are designed to withstand the repeated use required of high traffic lobbies and waiting areas. Add a finishing touch to any space with tables as distinctive as your seating.



Coffee Table

EFFECTIVE OCTOBER 17, 2022

Featured Models

END TABLE :: \$1,157

End table, standard black plastic feet

COFFEE TABLE :: \$1,595

Coffee table, wood tapered square feet

CORNER TABLE :: \$1,871

Corner table, brushed aluminum pole feet

MEZZANINE

EFFECTIVE OCTOBER 17, 2022 | GSA SIN #: 33721

Features

- Three functional cube designs
- Four finishes
- 10 foot/caster styles

1. Product

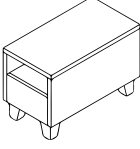
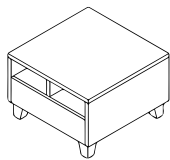
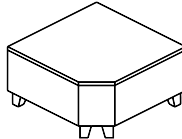
Table Type	Code	Price	
End Table	MCM TT1	\$1,157	
Coffee Table	MCM TT2	\$1,455	
Corner Table	MCM TT3	\$1,751	



End Table



END TABLE, COFFEE TABLE AND CORNER TABLE

2. Appearance

Table Finish Color	Code	Price	
Clear Maple	FCW1	+ \$0	
Medium Cherry	FCW2	+ \$0	
Amber Mahogany	FCW3	+ \$0	
Espresso	FCW4	+ \$0	
Stain-to-Match	STM	+ \$70	
New Custom Stain	STL	+ \$275	

New Custom Stain (STL): If stain is not in our library, add this one-time \$275 net fee in addition to the \$70 stain-to-match (STM) cost.

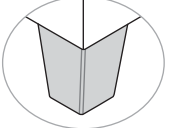
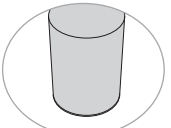
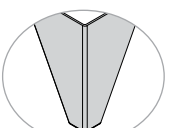
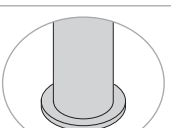
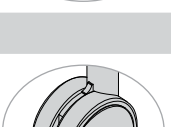
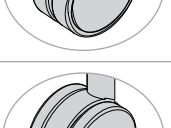
2. Feet

Foot Style and Color	Code	Price	
Feet			
Standard Plastic, Black	LS1	+ \$0	
Wood Tapered Square	LS12	+ \$140	
Wood Tapered Cylinder	LS11	+ \$140	
Metal Angular, Brushed Aluminum	LS6	+ \$120	
Metal 1.5" Pole, Brushed Aluminum	LS7	+ \$120	
Metal 1.5" Pole, Silver Powder Coat	LS8	+ \$120	
Castors			
Non-Locking Caster, Black	LS2	+ \$100	
Non-Locking Caster, Silver	LS3	+ \$100	
Locking Caster, Black	LS4	+ \$120	
Locking Caster, Silver	LS5	+ \$120	

EFFECTIVE OCTOBER 17, 2022 | GSA SIN #: 33721

3. Options

Ganging Brackets	Code	Price
One Set, Left-Attaching	XGVL	+ \$52
One Set, Right-Attaching	XGVR	+ \$52
Two Sets, Left- and Right-Attaching	XGV	+ \$103

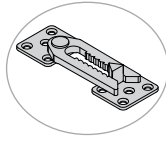

4. Packaging

Packaging	Code	Price
Knocked Down	P7	+ \$0

SPECIFICATIONS

Model:	MCM TT1 End Table	MCM TT2 Coffee Table	MCM TT3 Corner Table
Height	17"	17"	17"
Width	13.5"	25"	31.5"
Depth	25"	25"	31.5"
Weight	35 lb	52 lb	59 lb



Corner Table

Mezzanine

OCCASIONAL TABLE

Get in top shape.

Mezzanine® tables are available in two popular styles—cube and occasional. From the modernist cube to the transitional occasional style, these accent pieces are designed to complement any chair, settee or sofa. Built with the highest quality veneers and hardwoods, Mezzanine tables are designed to withstand the repeated use required of high traffic lobbies and waiting areas. Add a finishing touch to any space with tables as distinctive as your seating.



Square Occasional Table

EFFECTIVE OCTOBER 17, 2022

Featured Models

SQUARE :: \$1,594

Square occasional table, 21" tabletop, 24" high, wood tapered square legs

RECTANGULAR :: \$2,096

Rectangular occasional table, 48" tabletop, 24" high, wood tapered square legs





OVAL :: \$2,196

Oval occasional table, 48" tabletop, 18" high, brushed aluminum pole legs

Features

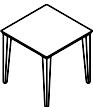
- Four occasional table shapes
- Three edge types
- Three leg styles
- Four wood stain finishes and stain-to-match program

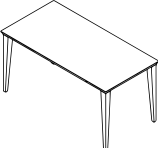
1. Product

Table Type	Code	Price	
Square Occasional Table	MZM TT8	\$1,534	
Round Occasional Table	MZM TT6	\$1,534	
Rectangular Occasional Table	MZM TT5	\$2,036	
Oval Occasional Table	MZM TT4	\$2,036	

2. Size

Table Top Size	Code	Price	
For Square and Round Tables			
21"	TZ21	+\$0	
24"	TZ24	+\$99	
36"	TZ36	+\$495	
For Rectangular and Oval Tables			
48"	TZ48	+\$0	
Table Height	Code	Price	
16"	TH16	+\$0	
18"	TH18	+\$20	
21"	TH21	+\$40	
24"	TH24	+\$60	

OCCASIONAL TABLES

3. Appearance

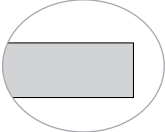
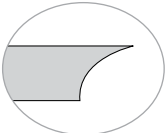
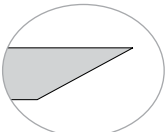
Table Top Edge Style	Code	Price	
Square	TE1	+\$0	
Bevel	TE2	+\$0	
Knife	TE3	+\$0	

Finish Color	Code	Price	
Clear Maple	FCW1	+\$0	
Medium Cherry	FCW2	+\$0	
Amber Mahogany	FCW3	+\$0	
Espresso	FCW4	+\$0	
Stain-to-Match	STM	+\$70	
New Custom Stain	STL	+\$275	

New Custom Stain (STL): If stain is not in our library, add this one-time \$275 net fee in addition to the \$70 stain-to-match (STM) cost.

4. Legs

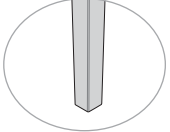
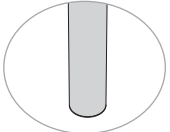
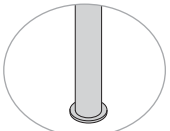
Leg Style	Code	Price	
Wood Tapered Square Leg	LSL2	+\$0	
Wood Tapered Cylinder Leg	LSL3	+\$0	
Metal 1.5" Pole, Brushed Aluminum Leg	LSL1	+\$140	

5. Options

Protection	Code	Price
Protective Wood Guard Clear Tape	LX1	+ \$84

Protective Wood Guard (LX1) is available on wood legs (LSL2/LSL3) only.

4. Packaging

Packaging	Code	Price
Knocked Down	P7	+ \$0

SPECIFICATIONS

Model:	MZM TT8 Square Table		
	21"	24"	36"
Width	21"	24"	36"
Depth	21"	24"	36"
Weight	30 lb	34 lb	57 lb
Model:	MZM TT6 Round Table		
	21"	24"	36"
Width	21"	24"	36"
Depth	21"	24"	36"
Weight	27 lb	30 lb	48 lb
Model:	MZM TT5 Rectangular Table		
Width	48"		
Depth	24"		
Weight	52 lb		
Model:	MZM TT4 Oval Table		
Width	48"		
Depth	24"		
Weight	52 lb		

Square, round, rectangular and oval tables are available in multiple heights.



Rectangular Occasional Table

Ocala

FLIP-TOP TABLES

Mighty and mobile.

The Ocala flip-top table is the simple yet sophisticated nesting table that solves all of your training and meeting room needs. Set-up takes just seconds—table surface flips and locks with the pull of a lever. The table nests for convenient, space-saving storage.



24" x 60"

Chair sold separately; see [page 78](#) for Movi.

EFFECTIVE OCTOBER 17, 2022

Featured Models

24" x 60" :: \$946

24" x 60" top, grade 1 laminate, flip-top base, no grommets

30" x 72" :: \$1,106

30" x 72" top, grade 1 laminate, flip-top base, no grommets

Features

- Welded and bolted construction with steel end caps
- Multiple laminate options to fit your style
- Optional grommets for easy and clean setup of electronic devices
- Silver and white base finishes
- Casters are standard on all models
- 60", 66" and 72" top lengths
- 130 lb weight capacity warranty

SPECIFICATIONS

	3061 TBT2 Ocala Flip-Top Table
Height	28.59"
Height With Top Flipped Up	41.11"
Base Length	58.99"
Foot Length:	21.9"
Base Top Support Length:	52.84"
Distance Between Legs:	50.15"
Weight Capacity Warranty	130 lb

Height includes 1.125" tabletop and casters.

See the Stand-Alone Tabletop appendix on [page 141](#) for tabletop weights.

TABLETOP

TOPS AND BASES ARE SPECIFIED AND SOLD SEPARATELY.

1. Product

Product Type	Code	Price
Tabletop	3061 TBT2	Priced by Size

2. Finish

Laminate	Code	Price
Grade 1 Laminate		
Ankara Cherry	TL18	Priced by Size
Black	TL19	Priced by Size
Brazilian Walnut	TL20	Priced by Size
Cabinet Maple	TL21	Priced by Size
Driftwood	TL23	Priced by Size
Folkstone Grey	TL24	Priced by Size
Libretti	TL25	Priced by Size
Queenston Oak	TL26	Priced by Size
Sandalwood	TL27	Priced by Size
Walnut Amati	TL28	Priced by Size
White	TL29	Priced by Size
Grade 2 Laminate		
Classic Linen	TL17	Priced by Size
Colombian Walnut	TL55	Priced by Size
Crisp Linen	TL64	Priced by Size
Designer White	TL66	Priced by Size
Field Elm	TL13	Priced by Size
Frosty White	TL16	Priced by Size
Grey	TL62	Priced by Size
Grey Elm	TL51	Priced by Size
Kingswood Walnut	TL53	Priced by Size
Manitoba	TL56	Priced by Size
Neo Walnut	TL50	Priced by Size
Platinum	TL61	Priced by Size
Portico Teak	TL60	Priced by Size
Skyline Walnut	TL15	Priced by Size
Steel Mesh	TL59	Priced by Size
Tuscan Walnut	TL57	Priced by Size
Uptown Walnut	TL14	Priced by Size
Laminate Grade	Code	Price
Laminate Grade 1	GR1	Priced by Size
Laminate Grade 2	GR2	Priced by Size

EFFECTIVE OCTOBER 17, 2022

TABLETOP

TOPS AND BASES ARE SPECIFIED AND SOLD SEPARATELY.

3. Shape

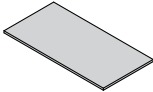
Product Type	Code	Price	
Rectangular Tabletop	TZ	Priced by Size	

4. Size

Tabletop Size (D x W)	Code	Price	
Rectangular Tabletop		Grade 1	Grade 2
24" x 60"	2460	\$324	\$486
24" x 66"	2466	\$358	\$537
24" x 72"	2472	\$389	\$584
30" x 60"	3060	\$404	\$606
30" x 66"	3066	\$445	\$668
30" x 72"	3072	\$484	\$726

5. Grommets

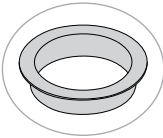
Grommet Location	Code	Price	
None	GP00	+ \$0	
Left	GP01	+ \$30	
Center	GP02	+ \$30	
Right	GP03	+ \$30	
Left and Center	GP04	+ \$60	
Left and Right	GP05	+ \$60	
Right and Center	GP06	+ \$60	
Left, Right and Center	GP07	+ \$90	
Grommet Color	Code	Price	
Black	GC01	+ \$0	
White	GC02	+ \$0	

EFFECTIVE OCTOBER 17, 2022

1. Product

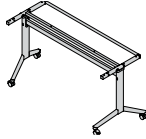
Product Type	Code	Price	
Flip-Top Base	3062 TBT2	\$622	

2. Finish

Paint Color	Code	Price
Silver	BF01	+ \$0
White	BF02	+ \$0

TABLE BASE

TOPS AND BASES ARE SPECIFIED AND SOLD SEPARATELY.

3. Matching Tabletop

Tabletop Shape	Code	Price
Matching Tabletop	TZ	+ \$0
Tabletop Size (D x W)	Code	Price
24" x 60"	TZ2460	+ \$0
24" x 66"	TZ2466	+ \$0
24" x 72"	TZ2472	+ \$0
30" x 60"	TZ3060	+ \$0
30" x 66"	TZ3066	+ \$0
30" x 72"	TZ3072	+ \$0

Bases require the specification of a tabletop size. Bases take their size from their corresponding tabletop.

1. Additional Options (Sold Separately)

Product Type	Code	Price	
Pair of Ganging Brackets	3159 XGV	\$50	



Parallon

TYPICALS

Everything to the table.

When you want cohesion in spaces large, small, shared or separate, there's Parallon. It's a single collection with a singular look, offering an array of choices for a variety of environments—and all the features to fit. Continue the cohesion even when it's time to “take five” from meeting or training. Our café + occasional tables help carry the design into your casual and touch-down spaces.



EFFECTIVE OCTOBER 17, 2022

1. Collaborative Hexagon

Category	Code	Quantity	Description	List Price	Ext Price
Tabletop	3271 TBT3 GR1 TPZ 3060 GP00	6	Trapezoidal Tabletop: 30" x 60", Grade 1 Laminate, No Grommets	\$600	\$3,600
Table Base	3272 TBT3C TPZ 3060 LS18	6	Fixed Top C-Leg Base, Glides	\$515	\$3,090
Ganging	3159 XGV	3	Pair of Ganging Brackets	\$50	\$150

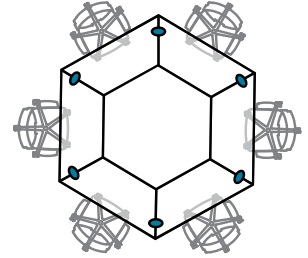

TOTAL: \$6,840

2. Small U-Shaped Training Space

Category	Code	Quantity	Description	List Price	Ext Price
Tabletop	3271 TBT3 GR1 TZ 3060 GP00	2	Rectangular Tabletop: 30" x 60", Grade 1 Laminate, No Grommets	\$385	\$770
Table Base	3272 TBT3 TZ 3060 TBT3C LS18	2	Fixed Top T-Leg Base, Glides (Pairs With 30" x 60" Rectangular Tabletop)	\$515	\$1,030
Tabletop	3271 TBT3 GR1 TPZ 3060 GP00	3	Trapezoidal Tabletop: 30" x 60", Grade 1 Laminate, No Grommets	\$600	\$1,800
Table Base	3272 TBT3 TPZ 3060 TBT3C LS18	3	Fixed Top T-Leg Base, Glides (Pairs With 30" x 60" Trapezoid Tabletop)	\$515	\$1,545
Ganging	3159 XGV	2	Pair of Ganging Brackets	\$50	\$100

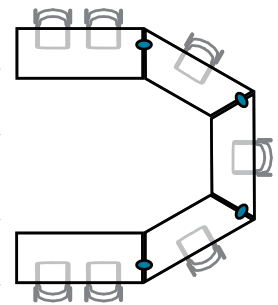

TOTAL: \$5,245

3. U-Shaped Training Space

Category	Code	Quantity	Description	List Price	Ext Price
Tabletop	3271 TBT2 GR1 TZ 3060 TE5 GP00	7	Rectangular Tabletop: 30" x 60", Grade 1 Laminate, No Grommets	\$385	\$2,695
Table Base	3260 TBT2 TZ 3072 LS18	7	Flip-Top T-Leg Base (Pairs With 30" x 60" Rectangular Tabletop)	\$723	\$5,061
Ganging	3159 XGV	6	Pair of Ganging Brackets	\$50	\$300

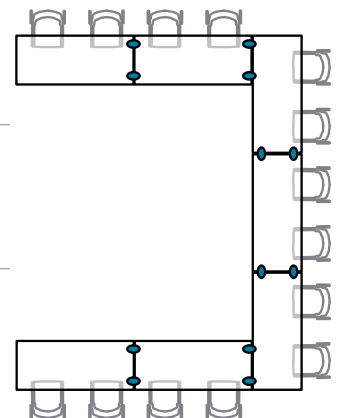

TOTAL: \$8,056

EFFECTIVE OCTOBER 17, 2022

4. Collaborative Trapezoid Workstation

Category	Code	Quantity	Description	List Price	Ext Price
Tabletop	3271 TBT3 GR1 TPZ 3060 TE5 GP00	8	Trapezoidal Tabletop: 30" x 60", Grade 1 Laminate, No Grommets	\$600	\$4,800
Table Base	3272 TBT3 TPZ 3060 TBT3C LS18	8	Fixed Top T-Leg Base, Casters Pairs With 30" x 60" Trapezoid Tabletop	\$515	\$4,120
Ganging	3159 XGV	4	Pair of Ganging Brackets	\$50	\$200
TOTAL:					\$9,120

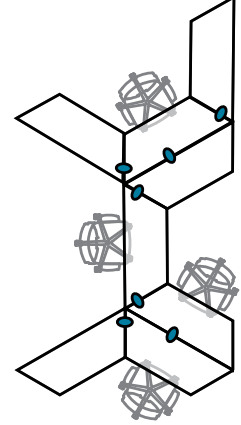

5. Classroom-Style, Individual Tables

Category	Code	Quantity	Description	List Price	Ext Price
Tabletop	3231 TBT2 GR2 TZ 3060 TE31 GP00	6	Rectangular Tabletop: 30" x 60", Grade 2 Laminate, Knife-Edged, No Grommets	\$694	\$4,164
Table Base	3272 TBT2 TZ 3060 LS18	6	Flip-Top T-Leg Base (Pairs With 30" x 60" Rectangular Tabletop)	\$723	\$4,338
TOTAL:					\$8,502

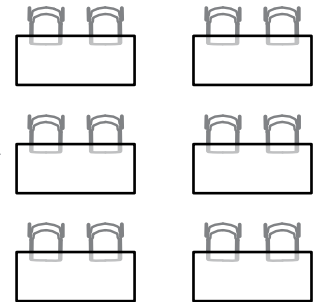

5. Classroom-Style, Rows

Category	Code	Quantity	Description	List Price	Ext Price
Tabletop	3271 TBT2 GR1 TZ 3060 TE5 GP00	6	Rectangular Tabletop: 30" x 60", Grade 1 Laminate, Flat-Edged No Grommets	\$385	\$2,310
Table Base	3272 TBT2C TZ 3060 LS18	6	Fixed-Top C-Leg Base, Casters (Pairs With 30" x 60" Half Round Tabletop)	\$515	\$3,090
Ganging	3159 XGV	4	Pair of Ganging Brackets	\$50	\$200
TOTAL:					\$5,600

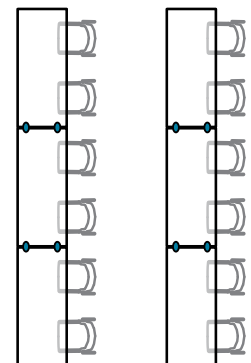

EFFECTIVE OCTOBER 17, 2022

6. Reconfigurable Conference Table

Category	Code	Quantity	Description	List Price	Ext Price
Tabletop	3231 TBT2 GR1 TZ 3060 TL27 GP00	6	Rectangular Tabletop: 30" x 60", Flat-Edged Laminate, No Grommets	\$385	\$2,310
Table Base	3272 TBT2 TZ 3060 LS18	6	Flip-Top T-Leg Base (Pairs With 30" x 60" Rectangular Tabletop)	\$515	\$3,090
Ganging	3159 XGV	5	Pair of Ganging Brackets	\$50	\$250
				TOTAL:	\$5,650

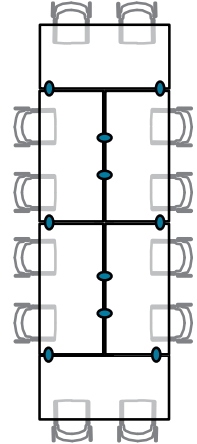

7. Impromptu Conference Table

Category	Code	Quantity	Description	List Price	Ext Price
Tabletop	3271 TBT3 GR1 TZ 3060 GP00	2	Rectangular Tabletop: 30" x 72", Grade 1 Laminate, No Grommets	\$450	\$900
Table Base	3272 TBT3 TZ 3060 TBT2 LS19	2	Fixed-Top T-Leg Base, Casters (Pairs With 30" x 72" Rectangular Tabletop)	\$515	\$1,030
Tabletop	3271 TBT3 GR1 THR 3060 GP00	2	Half-Round Tabletop: 30" x 60", Grade 1 Laminate, No Grommets	\$600	\$1,200
Table Base	3272 TBT3 TE5 THR 3060 LS19	2	Fixed-Top T-Leg Base, Casters (Pairs With 30" x 60" Half Round Tabletop)	\$515	\$1,030
Ganging	3159 XGV	3	Pair of Ganging Brackets	\$50	\$150
				TOTAL:	\$4,310

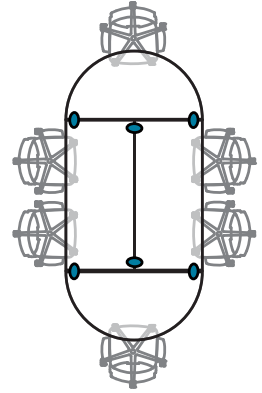

8. Collapsible Round

Category	Code	Quantity	Description	List Price	Ext Price
Tabletop	3271 TBT3 GR1 THR 3060 GP00	2	Half-Round Tabletop: 30" x 60", Grade 1 Laminate, No Grommets	\$600	\$1,200
Table Base	3272 TBT3 TE5 THR 3060 LS19	2	Flip-Top T-Leg Base, Casters (Pairs With 30" x 60" Half Round Tabletop)	\$723	\$1,446
Ganging	3159 XGV	1	Pair of Ganging Brackets	\$50	\$50
				TOTAL:	\$2,696

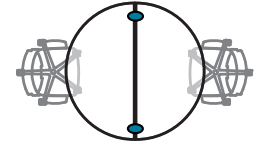

Parallon

FLIP-TOP AND FIXED TOP TRAINING TABLE

Everything to the table.

When you want cohesion in spaces large, small, shared or separate, there's Parallon. It's a single collection with a singular look, offering an array of choices for a variety of environments—and all the features to fit. Ensure design is never a distraction in the places where everyone needs to focus. Our Parallon line of training tables provides a unified and streamlined look from room to room.



30" x 60" Fixed Top
Chairs sold separately.
See [page 78](#) for Movi.

EFFECTIVE OCTOBER 17, 2022

Featured Models

30" x 60" T-LEG :: \$900

30" x 60" tabletop, grade 1 laminate, fixed base, glides

30" x 60" C-LEG :: \$1,115

30" x 60" trapezoid tabletop, grade 1 laminate, C-leg fixed base, glides

30" x 60" FLIP-TOP :: \$1,108

30" x 60" rectangular tabletop, grade 1 laminate, flip-top base, casters

Features

- A broad yet curated collection that's easy to specify across countless applications
- Developed entirely in-house (from the ground up) to make space cohesion effortless
- Training or collaboration—enjoy a variety of table types, tops, bases and more
- Soft-close flip-top models with quick-release latches can nest, store and deploy easily
- Powder-coated metal finishes in black, white or silver
- An array of 28 laminate options; 11 Grade 1 and 17 Grade 2
- 300 lb weight capacity warranty
- Exceeds BIFMA requirements for safety.

1. Product

Product Type	Code	Price
Tabletop	3271	Priced by Size
Table Base	Code	Price
Flip-Top, T-Leg	TBT2	Priced by Size
Fixed Top, T-Leg	TBT3	Priced by Size
Fixed Top, C-Leg	TBT3C	Priced by Size

2. Tabletop Finish

Laminate Color	Code	Price
Grade 1 Laminate		
Ankara Cherry	TL18	Priced by Size
Black	TL19	Priced by Size
Brazilian Walnut	TL20	Priced by Size
Cabinet Maple	TL21	Priced by Size
Driftwood	TL23	Priced by Size
Folkstone Grey	TL24	Priced by Size
Libretti	TL25	Priced by Size
Queenston Oak	TL26	Priced by Size
Sandalwood	TL27	Priced by Size
Walnut Amati	TL28	Priced by Size
White	TL29	Priced by Size

FLIP-TOP AND TRAINING TABLETOP TOPS AND BASES ARE SPECIFIED AND SOLD SEPARATELY.

2. Tabletop Finish

Laminate Color	Code	Price
Grade 2 (HPL) Laminates		
Classic Linen	TL17	Priced by Grade
Colombian Walnut	TL55	Priced by Grade
Crisp Linen	TL64	Priced by Grade
Designer White	TL66	Priced by Grade
Field Elm	TL13	Priced by Grade
Frosty White	TL16	Priced by Grade
Grey	TL62	Priced by Grade
Grey Elm	TL51	Priced by Grade
Kingswood Walnut	TL53	Priced by Grade
Manitoba	TL56	Priced by Grade
Neo Walnut	TL50	Priced by Grade
Platinum	TL61	Priced by Grade
Portico Teak	TL60	Priced by Grade
Skyline Walnut	TL15	Priced by Grade
Steel Mesh	TL59	Priced by Grade
Tuscan Walnut	TL57	Priced by Grade
Uptown Walnut	TL14	Priced by Grade
Laminate Grade	Code	Price
Grade 1	GR1	Priced by Size
Grade 2	GR2	Priced by Size

3. Shape

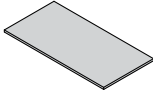
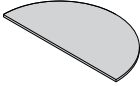
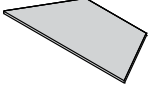
Tabletop Size	Code	Price	
Rectangular Tabletop	TZ	Priced by Size	
Half Round Tabletop	THR	Priced by Size	
Trapezoid Tabletop	TPZ	Priced by Size	

EFFECTIVE OCTOBER 17, 2022

4. Edge

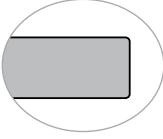
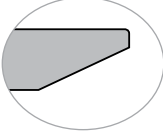
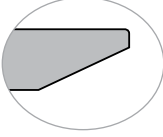
Edge Profile	Code	Price	
Flat Edge	TE5	Priced by Size	
Knife Edge, Front Only	TE31	Priced by Size	
Knife Edge, Front and Back	TE32	Priced by Size	

Knife edges are only available on grade 2 (GR2) laminate tabletops. Front and back knife edge option (TE5) is not available on half round (THR) tabletops.

5. Size

Tabletop Size	Code	Price		
Rectangular (D x W)		Grade 1 Flat Edge	Grade 2 Flat Edge	Grade 2 Knife Edge
18" x 42"	1842	\$176	\$264	\$317
18" x 48"	1848	\$200	\$300	\$360
18" x 54"	1854	\$225	\$338	\$406
18" x 60"	1860	\$248	\$372	\$447
18" x 66"	1866	\$275	\$413	\$496
18" x 72"	1872	\$300	\$450	\$540
24" x 42"	2442	\$229	\$344	\$413
24" x 48"	2448	\$261	\$392	\$471
24" x 54"	2454	\$292	\$438	\$526
24" x 60"	2460	\$324	\$486	\$584
24" x 66"	2466	\$358	\$537	\$645
24" x 72"	2472	\$389	\$584	\$701
30" x 42"	3042	\$285	\$428	\$514
30" x 48"	3048	\$324	\$486	\$584
30" x 54"	3054	\$366	\$549	\$659
30" x 60"	3060	\$385	\$578	\$694
30" x 66"	3066	\$445	\$668	\$802
30" x 72"	3072	\$450	\$675	\$810
36" x 42"	3642	\$540	\$810	\$972
36" x 48"	3648	\$570	\$855	\$1,026
36" x 54"	3654	\$625	\$938	\$1,126
36" x 60"	3660	\$700	\$1,050	\$1,260
36" x 66"	3666	\$790	\$1,185	\$1,422
36" x 72"	3672	\$800	\$1,200	\$1,440

FLIP-TOP AND TRAINING TABLETOP

TOPS AND BASES ARE SPECIFIED AND SOLD SEPARATELY.

5. Size (Cont.)

Tabletop Size	Code	Price		
Half Round		Grade 1 Flat Edge	Grade 2 Flat Edge	Grade 2 Knife Edge
24" x 48"	2448	\$340	\$510	\$612
30" x 60"	3060	\$600	\$900	\$1,080
Trapezoid		Grade 1 Flat Edge	Grade 2 Flat Edge	Grade 2 Knife Edge
24" x 48"	2448	\$340	\$510	\$612
30" x 60"	3060	\$600	\$900	\$1,080

36" (D) tabletops are not compatible with C-leg table bases.

6. Grommets

Grommet Location	Code	Price	
No Grommets	GP00	+ \$0	
Circular Grommets			
Left Only	GP01	+ \$30	
Center Only	GP02	+ \$30	
Right Only	GP03	+ \$30	
Left and Center	GP04	+ \$60	
Left and Right	GP05	+ \$60	
Right and Center	GP06	+ \$60	
Left, Right and Center	GP07	+ \$90	
Cutouts			
Precut for Parallon Power Accessory	GP08	+ \$30	
Grommet Color	Code	Price	
Black	GC01	+ \$0	
White	GC02	+ \$0	

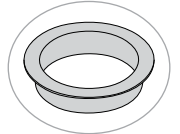

Cutout option (GP08) is intended for use with a power unit. Corresponding grommet comes packaged with the power, which is sold separately. See [page 40](#) to purchase Parallon power accessories.

Circular grommets cannot be paired with power options.

EFFECTIVE OCTOBER 17, 2022

1. Product

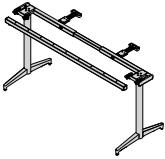
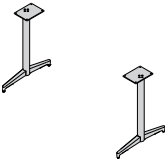
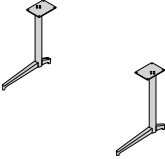
Product Type	Code	Price	
Table Base	3272	Priced by Base Style	
Base Style	Code	Price	
Flip-Top T	TBT2	\$723	
Fixed Top T	TBT3	\$515	
Fixed Top C	TBT3C	\$515	

2. Matching Tabletop

Tabletop Shape	Code	Price	
Half Round Tabletop	THR	+ \$0	
Rectangular Tabletop	TZ	+ \$0	
Trapezoid Tabletop	TPZ	+ \$0	

FLIP-TOP AND TRAINING TABLE BASE TOPS AND BASES ARE SPECIFIED AND SOLD SEPARATELY.

2. Matching Tabletop

Tabletop Size	Code	Price	
Rectangular			
18" x 42"	1842	+ \$0	
18" x 48"	1848	+ \$0	
18" x 54"	1854	+ \$0	
18" x 60"	1860	+ \$0	
18" x 66"	1866	+ \$0	
18" x 72"	1872	+ \$0	
24" x 42"	2442	+ \$0	
24" x 48"	2448	+ \$0	
24" x 54"	2454	+ \$0	
24" x 60"	2460	+ \$0	
24" x 66"	2466	+ \$0	
24" x 72"	2472	+ \$0	
30" x 42"	3042	+ \$0	
30" x 48"	3048	+ \$0	
30" x 54"	3054	+ \$0	
30" x 60"	3060	+ \$0	
30" x 66"	3066	+ \$0	
30" x 72"	3072	+ \$0	
36" x 42"	3642	+ \$0	
36" x 48"	3648	+ \$0	
36" x 54"	3654	+ \$0	
36" x 60"	3660	+ \$0	
36" x 66"	3666	+ \$0	
36" x 72"	3672	+ \$0	
Half Round			
24" x 48"	2448	+ \$0	
30" x 60"	3060	+ \$0	
Trapezoid			
24" x 48"	2448	+ \$0	
30" x 60"	3060	+ \$0	

C-leg bases are not compatible with 36" deep tabletops.

3. Base Finish

Paint Color	Code	Price
Silver	BF01	+ \$0
White	BF02	+ \$0
Black	BF03	+ \$0

4. Feet

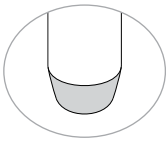
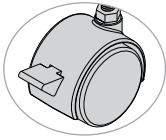
Foot Style	Code	Price	
Glides	LS18	+ \$0	
Casters	LS19	+ \$0	

Glide color will match base finish color. Casters (LS19) include two locking casters for the front feet and two non-locking casters for the back feet.



30" x 60" Flip-Top (Flipped and Nested)

FLIP-TOP AND TRAINING TABLE BASE

TOPS AND BASES ARE SPECIFIED AND SOLD SEPARATELY.

BASE SPECIFICATIONS

	Fixed T-Leg	Flip-Top T-Leg	Fixed C-Leg
Rectangular Tabletops			
18" x 42"	21.48 lb	30.92 lb	21.97 lb
18" x 48"	21.48 lb	36.04 lb	21.97 lb
18" x 54"	21.48 lb	36.69 lb	21.97 lb
18" x 60"	24.91 lb	37.54 lb	25.40 lb
18" x 66"	25.48 lb	38.19 lb	25.97 lb
18" x 72"	26.05 lb	39.04 lb	26.54 lb
24" x 42"	22.32 lb	31.98 lb	23.27 lb
24" x 48"	22.32 lb	37.10 lb	23.27 lb
24" x 54"	22.32 lb	37.75 lb	23.27 lb
24" x 60"	25.75 lb	38.60 lb	26.70 lb
24" x 66"	26.32 lb	39.25 lb	27.27 lb
24" x 72"	26.89 lb	40.10 lb	27.84 lb
30" x 42"	22.32 lb	32.12 lb	27.85 lb
30" x 48"	22.32 lb	37.24 lb	27.85 lb
30" x 54"	22.32 lb	37.89 lb	27.85 lb
30" x 60"	25.75 lb	38.74 lb	31.28 lb
30" x 66"	26.32 lb	39.39 lb	31.85 lb
30" x 72"	26.89 lb	40.24 lb	32.42 lb
36" x 42"	22.32 lb	32.12 lb	N/A
36" x 48"	22.32 lb	37.24 lb	N/A
36" x 54"	22.32 lb	37.89 lb	N/A
36" x 60"	25.75 lb	38.74 lb	N/A
36" x 66"	26.32 lb	39.39 lb	N/A
36" x 72"	26.89 lb	40.24 lb	N/A
Half Round Tabletops			
24" x 48"	21.48 lb	30.17 lb	21.97 lb
30" x 60"	22.32 lb	31.98 lb	23.27 lb
Trapezoid Tabletops			
24" x 48"	21.48 lb	29.42 lb	21.97 lb
30" x 60"	22.32 lb	31.23 lb	23.27 lb

See the Stand-Alone Tabletop appendix on page 141 for tabletop weights.

Features

- Daisy chain power and cable management will put a charge into any area
- Corded, hardwired daisy chain kit options: 5A/120V AC power receptacles and 2.1A/5V dual USB charging ports
- UL/ETL listed for US and Canada
- Hardwire power (4-circuit) for more demanding applications: 8 wire 4 circuit (3+1) system, single-sided quad power blocks, 4-15A/120V AC simplex receptacles, 4 data knockouts for RJ45 connectors -
- ETL listed for US and Canada.

1. Standalone Power Kit

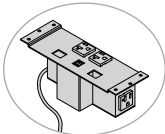
Product Type	Code	Price	
Standalone 3-Prong Infeed	3131 PV1 SA1	\$513	
Power Type	Code	Price	
2AC, Dual USB, 2 Data	PT8	+ \$0	
Power Color	Code	Price	
Silver	PC2	+ \$0	

ACCESSORIES AND POWER

EACH PRODUCT SOLD SEPARATELY.

1. Daisy Chain Power

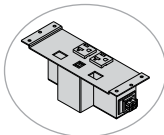
Daisy Chain Power Kit	Code	Price	
Single Quick Kit	3131 PV1 Q1	\$652	
Table Length	Code	Price	
48"	DL48	+ \$0	
60"	DL60	+ \$21	
72"	DL72	+ \$42	
Power Type	Code	Price	
2AC, Dual USB, 2 Data	PT8	+ \$0	
Power Color	Code	Price	
Silver	PC2	+ \$0	

2. Daisy Chain Power Infeed

Product Type	Code	Price	
Power Infeed	3131 PV1 IF	Priced by Style	
Product Style	Code	Price	
Hardwire, 72"	HWC72	+ \$160	
20-Amp, 3-Prong, 72"	TPC72	+ \$244	

Maximum of 9 tables per infeed.

EFFECTIVE OCTOBER 17, 2022

1. Hardwire Power

Power Style	Code	Price	
4-Circuit, Single Sided, Power and Data Ready	3132 PS1 SB1 PT7	\$369	
Power Color	Code	Price	
Black	PC1	+ \$0	

2. Hardwire Power Linking Cables

Linking Cables	Code	Price	
8-Wire, 4-Circuit Interconnect Cables	3132 PS1 IC	Priced by Style	
Length (IC Only)	Code	Price	
42" for 48" Tabletops	IC42	\$130	
54" for 60" Tabletops	IC54	\$167	
66" for 72" Tabletops	IC66	\$205	

3. Hardwire Power Infeed

Product Style	Code	Price	
Hardwire Power Infeed, 72"	3132 PS1 IF HWC72	\$221	

Maximum of 5 linked tables per circuit. Maximum of 20 linked tables if all 4 circuits are used.

1. Wire Management

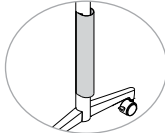
Product Type	Code	Price	
Vertical Wire Leg Cover	3279 WM07	\$56	
Paint Color	Code	Price	
Silver	WMC01	\$0	
White	WMC02	\$0	
Black	WMC03	\$0	

1. Other Accessories

Ganging	Code	Price	
Pair of Ganging Brackets	3159 XGV	\$50	

ACCESSORIES AND POWER

EACH PRODUCT SOLD SEPARATELY.

NUMBER OF GANGING BRACKET LOCATIONS

	Flat Edge	Knife Edge (Front Only)	Knife Edge (Front and Back)
T-Leg Flip-Top Rectangle			
18" (D) x 42"-66" (W)	10	6	2
18" (D) x 72" (W)	8	6	2
24" Deep	10	6	2
30" Deep	12	8	4
36" Deep	12	8	4
T-Leg Fixed-Top Rectangle			
18" Deep	12	8	4
24" Deep	10	6	2
30" Deep	12	8	4
36" Deep	12	8	4
C-Leg Fixed-Top Rectangle			
18" Deep	8	4	2
24" Deep	8	4	2
30" Deep	12	8	4
T-Leg Flip-Top Half Round			
24" Deep	6	4	4
30" Deep	6	4	4
T-Leg Fixed-Top Half Round			
24" Deep	6	4	4
30" Deep	6	4	4
C-Leg Fixed-Top Half Round			
24" Deep	6	4	4
30" Deep	6	4	4
T-Leg Flip-Top Trapezoid			
24" Deep	6	4	4
30" Deep	6	4	4
T-Leg Fixed-Top Trapezoid			
24" Deep	6	4	4
30" Deep	6	4	4
C-Leg Fixed-Top Trapezoid			
24" Deep	6	4	4
30" Deep	6	4	4

Parallon

MEETING, CAFÉ AND OCCASIONAL TABLE

Everything to the table.

When you want cohesion in spaces large, small, shared or separate, there's Parallon. It's a single collection with a singular look, offering an array of choices for a variety of environments—and all the features to fit. Continue the cohesion even when it's time to “take five” from meeting or training. Our café + occasional tables help carry the design into your casual and touch-down spaces.



Meeting Table
Chairs sold separately. See [page 74](#) for Hexy.

EFFECTIVE OCTOBER 17, 2022

Featured Models

MEETING :: \$1,868

36" x 72" rectangular laminate tabletop, dual disc base, 29" column height, grade 1 laminate

CAFÉ :: \$902

36" square laminate tabletop, grade 1 laminate, 42" column height, disc-base

OCCASIONAL :: \$557

24" round laminate tabletop, grade 1 laminate, 16" column height, x-base,

Features

- A broad yet curated collection that's easy to specify across countless applications
- Developed entirely in-house (from the ground up) to make space cohesion effortless
- Meeting, café or occasional—enjoy a variety of table types, tops, bases and more
- Five column height choices
- Powder-coated metal finishes in black, white or silver
- Universal built-in desktop power fits all outlet types, including AC, USB-A and USB-C
- An array of 28 laminate options; 11 Grade 1 and 17 Grade 2
- 300 lb weight capacity warranty
- Exceeds BIFMA requirements for safety

1. Product

Product Type	Code	Price
Tabletop	3271	Priced by Size
Pairs With	Code	Price
X-Base Café/Occasional	TBT4	Priced by Size
X-Base Power Ready	TBT4P	Priced by Size
Disc-Base	TBT15	Priced by Size
Disc Base Power Ready	TBT15P	Priced by Size
Dual Disc-Base	TBT16	Priced by Size
Dual Disc Base Power Ready	TBT16P	Priced by Size

2. Tabletop Finish

Laminate Color	Code	Price
Grade 1 Laminate		
Ankara Cherry	TL18	Priced by Grade
Black	TL19	Priced by Grade
Brazilian Walnut	TL20	Priced by Grade
Cabinet Maple	TL21	Priced by Grade
Driftwood	TL23	Priced by Grade
Folkstone Grey	TL24	Priced by Grade
Libretti	TL25	Priced by Grade
Queenston Oak	TL26	Priced by Grade
Sandalwood	TL27	Priced by Grade
Walnut Amati	TL28	Priced by Grade
White	TL29	Priced by Grade
Grade 2 Laminate		
Classic Linen	TL17	Priced by Grade
Colombian Walnut	TL55	Priced by Grade
Crisp Linen	TL64	Priced by Grade
Designer White	TL66	Priced by Grade
Field Elm	TL13	Priced by Grade
Frosty White	TL16	Priced by Grade
Grey	TL62	Priced by Grade
Grey Elm	TL51	Priced by Grade
Kingswood Walnut	TL53	Priced by Grade
Manitoba	TL56	Priced by Grade
Neo Walnut	TL50	Priced by Grade
Platinum	TL61	Priced by Grade
Portico Teak	TL60	Priced by Grade
Skyline Walnut	TL15	Priced by Grade
Steel Mesh	TL59	Priced by Grade
Tuscan Walnut	TL57	Priced by Grade
Uptown Walnut	TL14	Priced by Grade
Laminate Grade	Code	Price
Laminate Grade 1	GR1	Priced by Size
Laminate Grade 2	GR2	Priced by Size

3. Shape

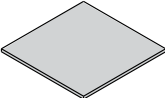
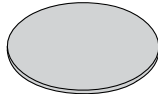
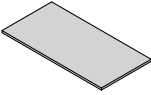
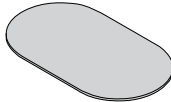
Tabletop Shape	Code	Price	
Square	TS	Priced by Size	
Round	TR	Priced by Size	
Rectangular	TZ	Priced by Size	
Racetrack	TK	Priced by Size	

Actual size of 30" x 30" tabletop is 30.75" x 30.75".

4. Edge

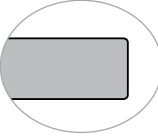
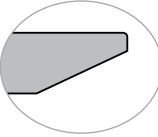
Edge Profile	Code	Price	
Flat Edge	TE5	+ \$0	
Knife Edge, All Sides	TE3	+ \$0	

Knife edges are only available on grade 2 (GR2) laminate tabletops.

5. Size

Tabletop Size	Code	Laminate Price		
Occasional and Café (Square or Round)		Grade 1 Flat Edge	Grade 2 Flat Edge	Grade 2 Knife Edge
24"	2424	\$274	\$411	\$494
30"	3030	\$297	\$446	\$536
36"	3636	\$345	\$518	\$622
42"	4242	\$385	\$578	\$694
48"	4848	\$458	\$687	\$825
54"	5454	\$800	\$1,200	\$1,440
60"	6060	\$1,200	\$1,800	\$2,160
Meeting (Rectangular or Racetrack)		Grade 1 Flat Edge	Grade 2 Flat Edge	Grade 2 Knife Edge
24" x 60"	2460	\$324	\$486	\$584
30" x 72"	3072	\$450	\$675	\$810
30" x 84"	3084	\$565	\$848	\$1,018
30" x 96"	3096	\$850	\$1,275	\$1,530
36" x 72"	3672	\$800	\$1,200	\$1,440
36" x 84"	3684	\$875	\$1,313	\$1,576
36" x 96"	3696	\$950	\$1,425	\$1,710

Actual size of 30" x 30" tabletop is 30.75" x 30.75".

Disc base is not available with 54" and 60" tabletops. 16", 20", and 42" tall columns are not compatible with 54" and 60" tabletops.

6. Edge

Grommet/Power Location (Power-Ready Models Only)	Code	Price	
Round and Square Tabletop			
Center Only	TE5	+ \$30	
Racetrack and Rectangular Tabletop			
Left Only	TE5	+ \$30	
Right Only	TE5	+ \$30	
Left and Right	TE5	+ \$60	

1. Product

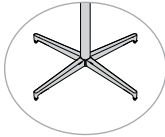
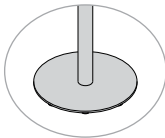
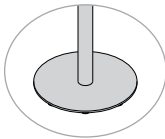
Product Type	Code	Price	
Table Base	3272	Priced by Column Height	
Base Style	Code	Price	
Round and Square Tabletops			
X-Base	TBT4	\$356	
X-Base Power Ready	TBT4P	\$496	
Disc-Base	TBT15	\$534	
Disc Base Power Ready	TBT15P	\$674	
Racetrack and Rectangular Tabletops			
Dual Disc-Base	TBT16	\$1068	
Dual Disc Base Power Ready	TBT16P	\$1,348	

Power module (PT111) must be ordered separately.

2. Base Finish

Paint Color	Code	Price	
Silver	BF01	+ \$0	
White	BF02	+ \$0	
Black	BF03	+ \$0	

3. Power

Standalone Power Unit	Code	Price	
1AC-1USBA-1USBC Outlet With 8 Foot Cable	PT111	+ \$335	
Power Color	Code	Price	
Black	PC1	+ \$0	
White	PC4	+ \$0	

MEETING, CAFÉ AND OCCASIONAL TABLETOP TOPS AND BASES ARE SPECIFIED AND SOLD SEPARATELY.

4. Matching Tabletop

Table Top Size	Code	Price	
Occasional and Café (Square or Round)			
24"	2424	+ \$0	
30"	3030	+ \$0	
36"	3636	+ \$0	
42"	4242	+ \$0	
48"	4848	+ \$0	
54"	5454	+ \$0	
60"	6060	+ \$0	
Meeting (Rectangular or Racetrack)			
24" x 60"	2460	+ \$0	
30" x 72"	3072	+ \$0	
30" x 84"	3084	+ \$0	
30" x 96"	3096	+ \$0	
36" x 72"	3672	+ \$0	
36" x 84"	3684	+ \$0	
36" x 96"	3696	+ \$0	

Table bases require the specification of a tabletop size. Bases take their size from their corresponding top size.

Disc base is not available with 54" and 60" tabletops. 16", 20" and 42" height columns are not compatible with 54" and 60" tabletops.

5. Height

Column Height	Code	Price	
Occasional (Square or Round)			
16"	TH16	- \$53	
20"	TH20	- \$43	
Café (Square or Round)			
29"	TH29	+ \$0	
36"	TH36	+ \$11	
42"	TH42	+ \$23	
Meeting (Rectangular or Racetrack)			
29"	TH29	+ \$0	
36"	TH36	+ \$22	
42"	TH42	+ \$46	

6. Feet

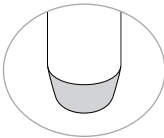
Foot Style	Code	Price	
Glides	LS18	+ \$0	

Glide color will match base finish color.

SPECIFICATIONS: WEIGHT

Table Depth	X-Base	Disc-Base
Square Tabletop		
24" × 16" (H)	15.35 lb	78.25 lb
24" × 20" (H)	16.25 lb	79.47 lb
24" × 29" (H)	18.26 lb	80.95 lb
24" × 36" (H)	19.85 lb	84.33 lb
24" × 42" (H)	21.20 lb	84.90 lb
30" × 16" (H)	17.95 lb	78.25 lb
30" × 20" (H)	18.85 lb	79.47 lb
30" × 29" (H)	20.86 lb	80.95 lb
30" × 36" (H)	22.45 lb	84.33 lb
30" × 42" (H)	23.80 lb	84.90 lb
36" × 16" (H)	17.95 lb	78.25 lb
36" × 20" (H)	18.85 lb	79.47 lb
36" × 29" (H)	20.86 lb	80.95 lb
36" × 36" (H)	22.45 lb	84.33 lb
36" × 42" (H)	23.80 lb	84.90 lb
42" × 16" (H)	19.19 lb	78.25 lb
42" × 20" (H)	20.09 lb	79.47 lb
42" × 29" (H)	22.10 lb	80.95 lb
42" × 36" (H)	23.69 lb	84.33 lb
42" × 42" (H)	25.04 lb	84.90 lb
48" × 16" (H)	19.19 lb	78.25 lb
48" × 20" (H)	20.09 lb	79.47 lb
48" × 29" (H)	22.10 lb	80.95 lb
48" × 36" (H)	23.69 lb	84.33 lb
48" × 42" (H)	25.04 lb	84.90 lb
54" × 29" (H)	22.10 lb	80.95 lb
54" × 36" (H)	23.69 lb	84.33 lb
60" × 29" (H)	22.10 lb	80.95 lb
60" × 36" (H)	23.69 lb	84.33 lb
Round Tabletop		
24" × 16" (H)	15.35 lb	52.92 lb
24" × 20" (H)	16.25 lb	54.14 lb
24" × 29" (H)	18.26 lb	55.62 lb
24" × 36" (H)	19.85 lb	59 lb
24" × 42" (H)	21.2 lb	59.57 lb
30" × 16" (H)	15.35 lb	52.92 lb
30" × 20" (H)	16.25 lb	54.14 lb
30" × 29" (H)	18.26 lb	55.62 lb
30" × 36" (H)	19.85 lb	59 lb
30" × 42" (H)	21.2 lb	59.57 lb
36" × 16" (H)	17.95 lb	52.92 lb
36" × 20" (H)	18.85 lb	54.14 lb
36" × 29" (H)	20.86 lb	55.62 lb
36" × 36" (H)	22.45 lb	59 lb
36" × 42" (H)	23.8 lb	59.57 lb
42" × 16" (H)	19.19 lb	52.92 lb
42" × 20" (H)	20.09 lb	54.14 lb
42" × 29" (H)	22.1 lb	55.62 lb
42" × 36" (H)	23.69 lb	59 lb
42" × 42" (H)	25.04 lb	59.57 lb
48" × 16" (H)	19.19 lb	52.92 lb
48" × 20" (H)	20.09 lb	54.14 lb
48" × 29" (H)	22.1 lb	55.62 lb
48" × 36" (H)	23.69 lb	59 lb
48" × 42" (H)	25.04 lb	59.57 lb
54" × 29" (H)	22.1 lb	55.62 lb
54" × 36" (H)	23.69 lb	59 lb
60" × 29" (H)	22.1 lb	55.62 lb
60" × 36" (H)	23.69 lb	59 lb

SPECIFICATIONS: WEIGHT

Table Depth	Disc-Base
Rectangular Tabletop	
24" × 29" (H)	161.90 lb
24" × 36" (H)	168.66 lb
24" × 42" (H)	169.80 lb
30" × 29" (H)	161.90 lb
30" × 36" (H)	168.66 lb
30" × 42" (H)	169.80 lb
36" × 29" (H)	161.90 lb
36" × 36" (H)	168.66 lb
36" × 42" (H)	169.80 lb
Racetrack Tabletop	
24" × 29" (H)	111.24 lb
24" × 36" (H)	118.00 lb
24" × 42" (H)	119.14 lb
30" × 29" (H)	111.24 lb
30" × 36" (H)	118.00 lb
30" × 42" (H)	119.14 lb
36" × 29" (H)	111.24 lb
36" × 36" (H)	118.00 lb
36" × 42" (H)	119.14 lb

See the Stand-Alone Tabletop appendix on page 141 for tabletop weights.

SPECIFICATIONS: DIMENSIONS

Table Depth	X-Base	Disc-Base	Dual Disc
	Diagonal Footprint	Base Diameter	Base Diameter
24"	22.58"	21.00"	21.00"
30"	22.58"	21.00"	21.00"
36"	34.08"	21.00"	21.00"
42"	38.08"	27.00"	
48"	38.08"	27.00"	
54"	38.08"		
60"	38.08"		
	Column Diameter		
	2.25"	3"	3"
	Disc Base Thickness		
		0.39"	

Surge

2-LEG HEIGHT-ADJUSTABLE TABLE

Well-made wellness.

Add elevated design and sound ergonomics to any workspace with our Surge™ height-adjustable table. From a speedy three-step base assembly (no screws needed) to three programmable height settings for quick adjusting, you'll get up and running in no time. And the array of options makes space coordination a breeze.



EFFECTIVE OCTOBER 17, 2022

Featured Models

2-STAGE T-LEG :: \$1,108

2-Stage T-leg base, 24" x 60" laminate top, grade 1 laminate, no grommets, glides

2-STAGE T-LEG :: \$1,188

2-Stage T-leg base, 30" x 60" laminate top, grade 1 laminate, no grommets, glides

Features

- Support healthy working postures, whether seated or standing
- Surge offers a height range of 26.9"–46.6" (excluding top)
- Weight capacity warranty, including worksurface: Rated load is 250 lb at 10,000 cycles; maximum load is 265 lb
- Quick installation features an enhanced and exclusive locking mechanism
- Advanced anti-collision Sensor stops (and retracts) the table upon contact with any objects
- LED height display and push-button controls offer three user-customizable positions
- Available with T-leg and C-leg on adjustable glides
- 28 different durable laminate options to fit your style
- Three durable powder-coated metal finishes in silver, black or white
- Adjustment speed: 1.4 inches per second
- Operational noise level: approximately 48 dB (not including ambient noise)
- UL Certified and meets BIFMA X5.5 Certification

SPECIFICATIONS

Model:	3301/3302 TBT6/TBT6C
Dimensions	
Min and Max Height (Base Only)	26.9"–46.6"
Min and Max Height (With Table Top)	28"–47.7"
Foot Length With 23", 24" Tabletop Depth	22.72"
Foot Length With 29", 30" Tabletop Depth	28.62"
Tabletop Thickness	1.125"
Adjustment Speed	1.4 Inches Per Second
Number of Crossbar	2
Standby Power Consumption	2.6W
Noise	Approximately 48 DB (Not Including Ambient Noise)
Power Cord Lengths	106"
Rated Load Weight Capacity Warranty (Incl. Worksurface)	250 lb at 10,000 Cycles
Maximum Load Capacity (Incl. Worksurface)	265 lb

1. Tabletop

Product Type	Code	Price	
Height-Adjustable Table	3301	Priced by Size	
Product Style	Code	Price	
2-Stage T-Leg Base	TBT6	Priced by Size	
2-Stage C-Leg Base	TBT6C	Priced by Size	
Laminate	Code	Price	
Grade 1			
Ankara Cherry	TL18	Priced by Size	
Black	TL19	Priced by Size	
Brazilian Walnut	TL20	Priced by Size	
Cabinet Maple	TL21	Priced by Size	
Driftwood	TL23	Priced by Size	
Folkstone Grey	TL24	Priced by Size	
Libretti	TL25	Priced by Size	
Queenston Oak	TL26	Priced by Size	
Sandalwood	TL27	Priced by Size	
Walnut Amati	TL28	Priced by Size	
White	TL29	Priced by Size	
Laminate	Code	Price	
Grade 2			
Classic Linen	TL17	Priced by Size	
Colombian Walnut	TL55	Priced by Size	
Crisp Linen	TL64	Priced by Size	
Designer White	TL66	Priced by Size	
Field Elm	TL13	Priced by Size	
Frosty White	TL16	Priced by Size	
Grey	TL62	Priced by Size	
Grey Elm	TL51	Priced by Size	
Kingswood Walnut	TL53	Priced by Size	
Manitoba	TL56	Priced by Size	
Neo Walnut	TL50	Priced by Size	
Platinum	TL61	Priced by Size	
Portico Teak	TL60	Priced by Size	
Skyline Walnut	TL15	Priced by Size	
Steel Mesh	TL59	Priced by Size	
Tuscan Walnut	TL57	Priced by Size	
Uptown Walnut	TL14	Priced by Size	
Laminate Grade	Code	Price	
Laminate Grade 1	GR1	Priced by Size	
Laminate Grade 2	GR2	Priced by Size	

1. Tabletop (Cont.)

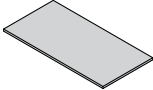
Tabletop Shape	Code	Price	
Rectangular	TZ	Priced by Size	

Tabletop Size	Code	Laminate Price	
Rectangular (D x W)		Grade 1	Grade 2
23" x 46"	TZ2346	\$261	\$392
23" x 52"	TZ2352	\$292	\$438
23" x 58"	TZ2358	\$324	\$486
23" x 64"	TZ2364	\$358	\$537
23" x 70"	TZ2370	\$389	\$584
23" x 76"	TZ2376	\$421	\$632
23" x 82"	TZ2382	\$453	\$680
24" x 42"	TZ2442	\$229	\$344
24" x 48"	TZ2448	\$261	\$392
24" x 54"	TZ2454	\$292	\$438
24" x 60"	TZ2460	\$324	\$486
24" x 66"	TZ2466	\$358	\$537
24" x 72"	TZ2472	\$389	\$584
24" x 78"	TZ2478	\$421	\$632
24" x 84"	TZ2484	\$453	\$680
29" x 46"	TZ2946	\$324	\$486
29" x 52"	TZ2952	\$366	\$549
29" x 58"	TZ2958	\$404	\$606
29" x 64"	TZ2964	\$445	\$668
29" x 70"	TZ2970	\$484	\$726
29" x 76"	TZ2976	\$526	\$789
29" x 82"	TZ2982	\$565	\$848
30" x 42"	TZ3042	\$285	\$428
30" x 48"	TZ3048	\$324	\$486
30" x 54"	TZ3054	\$366	\$549
30" x 60"	TZ3060	\$404	\$606
30" x 66"	TZ3066	\$445	\$668
30" x 72"	TZ3072	\$484	\$726
30" x 78"	TZ3078	\$526	\$789
30" x 84"	TZ3084	\$565	\$848

TABLE TOP

1. Tabletop (Cont.)

Grommet Location	Code	Price	
None	GP00	+ \$0	
Left	GP01	+ \$30	
Center	GP02	+ \$30	
Right	GP03	+ \$30	
Left and Center	GP04	+ \$60	
Left and Right	GP05	+ \$60	
Right and Center	GP06	+ \$60	
Left, Right and Center	GP07	+ \$90	

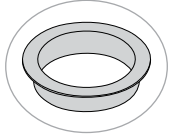

Grommet Color	Code	Price	
Black	GC01	+ \$0	
White	GC02	+ \$0	

Pilot Holes	Code	Price	
No Pre-Drilling for Accessories	BNDL00	+ \$0	

EFFECTIVE OCTOBER 17, 2022

1. Base

Product Type	Code	Price	
2-Leg Base	3302	Priced by Style	

Base Style	Code	Price	
------------	------	-------	--

2-Stage T-Leg Base

TBT6

\$784

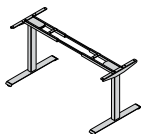

2-Stage C-Leg Base

TBT6C

\$784

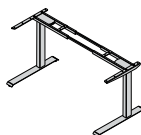

TABLE BASE

2. Matching Tabletop

Tabletop Shape	Code	Price	
Rectangular	TZ	Priced by Style	

Tabletop Size	Code	Price	
---------------	------	-------	--

23" x 46"	TZ2346	+\$0	+\$0
23" x 52"	TZ2352	+\$0	+\$0
23" x 58"	TZ2358	+\$0	+\$0
23" x 64"	TZ2364	+\$0	+\$0
23" x 70"	TZ2370	+\$0	+\$0
23" x 76"	TZ2376	+\$0	+\$0
23" x 82"	TZ2382	+\$0	+\$0
24" x 42"	TZ2442	+\$0	+\$0
24" x 48"	TZ2448	+\$0	+\$0
24" x 54"	TZ2454	+\$0	+\$0
24" x 60"	TZ2460	+\$0	+\$0
24" x 66"	TZ2466	+\$0	+\$0
24" x 72"	TZ2472	+\$0	+\$0
24" x 78"	TZ2478	+\$0	+\$0
24" x 84"	TZ2484	+\$0	+\$0
29" x 46"	TZ2946	+\$0	+\$0
29" x 52"	TZ2952	+\$0	+\$0
29" x 58"	TZ2958	+\$0	+\$0
29" x 64"	TZ2964	+\$0	+\$0
29" x 70"	TZ2970	+\$0	+\$0
29" x 76"	TZ2976	+\$0	+\$0
29" x 82"	TZ2982	+\$0	+\$0
30" x 42"	TZ3042	+\$0	+\$0
30" x 48"	TZ3048	+\$0	+\$0
30" x 54"	TZ3054	+\$0	+\$0
30" x 60"	TZ3060	+\$0	+\$0
30" x 66"	TZ3066	+\$0	+\$0
30" x 72"	TZ3072	+\$0	+\$0
30" x 78"	TZ3078	+\$0	+\$0
30" x 84"	TZ3084	+\$0	+\$0

Switchback

2-LEG HEIGHT-ADJUSTABLE TABLE BUNDLE

Find your fit.

Create a smarter workplace solution with Switchback, our number one height-adjustable table. Known for its class-leading anti-collision technology, compact shipping size and instant installation, it's the go-to for a dynamic workspace—and it gets even better when you bundle it with screens, power modules and keyboard trays for a complete, multifunctional workstation.



EFFECTIVE OCTOBER 17, 2022

Featured Models

ALL-IN-ONE :: \$4,791

2-leg 3-stage base, fixed glides, 24" x 60" pre-drilled rectangular tabletop, no grommets, height-adjustable screen mount, 30" x 60" fabric screen, Cable Caddy basket with power strip, laptop tray with HAT mechanism and U-brackets for crossrails, mini platform keyboard tray with mini trackless mechanism, half moon pencil drawer, Current clamp mount power module, Unity G2 single screen monitor arm, mobile pedestal with upholstered pad

Features

- The bundle can be built with any of Switchback's 2-leg models
- Switchback has three available base finishes and eleven tabletop finishes to fit your style
- Bundles have easy specification and installation; order together and the pilot holes for the accessories will be predrilled and ready to go
- Multiple monitor arm choices, including heavy duty options that support up to 33 lb
- Wire management and power module options to keep all of your electronics organized and powered on

1. Switchback Tabletop

Product Type	Code	Price
Tabletop	3161	Priced by Size
Product Style	Code	Price
2-Stage T-Leg Base	TBT6	Priced by Size
3-Stage T-Leg Base	TBT7	Priced by Size
2-Stage C-Leg Base	TBT6C	Priced by Size
3-Stage, C-Leg Base	TBT7C	Priced by Size
Laminate	Code	Price
Grade 1		
Ankara Cherry	TL18	Priced by Size
Black	TL19	Priced by Size
Brazilian Walnut	TL20	Priced by Size
Cabinet Maple	TL21	Priced by Size
Driftwood	TL23	Priced by Size
Folkstone Grey	TL24	Priced by Size
Libretti	TL25	Priced by Size
Queenston Oak	TL26	Priced by Size
Sandalwood	TL27	Priced by Size
Walnut Amati	TL28	Priced by Size
White	TL29	Priced by Size

SWITCHBACK BUNDLE

1. Switchback Tabletop (Cont.)

Laminate	Code	Price
Grade 2		
Classic Linen	TL17	Priced by Size
Colombian Walnut	TL55	Priced by Size
Crisp Linen	TL64	Priced by Size
Designer White	TL66	Priced by Size
Field Elm	TL13	Priced by Size
Frosty White	TL16	Priced by Size
Grey	TL62	Priced by Size
Grey Elm	TL51	Priced by Size
Kingswood Walnut	TL53	Priced by Size
Manitoba	TL56	Priced by Size
Neo Walnut	TL50	Priced by Size
Platinum	TL61	Priced by Size
Portico Teak	TL60	Priced by Size
Skyline Walnut	TL15	Priced by Size
Steel Mesh	TL59	Priced by Size
Tuscan Walnut	TL57	Priced by Size
Uptown Walnut	TL14	Priced by Size

Laminate Grade	Code	Price
Laminate Grade 1	GR1	Priced by Size
Laminate Grade 2	GR2	Priced by Size
Tabletop Shape	Code	Price

Rectangular TZ Priced by Size

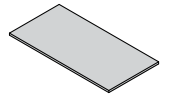

Tabletop Size	Code	Laminate Price	
Rectangular (D x W)		Grade 1	Grade 2
24" x 60"	2460	\$324	\$486
24" x 66"	2466	\$358	\$537
24" x 72"	2472	\$389	\$584
30" x 60"	3060	\$404	\$606
30" x 66"	3066	\$445	\$668
30" x 72"	3072	\$484	\$726

SWITCHBACK

EFFECTIVE OCTOBER 17, 2022

1. Switchback Tabletop (Cont.)

Grommet Location	Code	Price
None	GP00	+ \$0
Left	GP01	+ \$30
Center	GP02	+ \$30
Right	GP03	+ \$30
Left and Center	GP04	+ \$60
Left and Right	GP05	+ \$60
Right and Center	GP06	+ \$60
Left, Right and Center	GP07	+ \$90

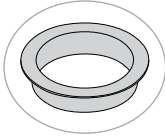

Grommet Color	Code	Price
Black	GC01	+ \$0
White	GC02	+ \$0

Pilot Holes	Code	Price
Pre-Drilled for Accessories	BNDL01	+ \$0

2. Switchback 2-Leg Base

Product Type	Code	Price
2-Leg Base	3162	Priced by Style

Base Style	Code	Price
2-Stage T-Leg Base	TBT6	\$874
3-Stage T-Leg Base	TBT7	\$1,005
2-Stage C-Leg Base	TBT6C	\$874
3-Stage C-Leg Base	TBT7C	\$1,005

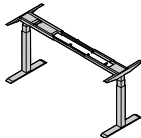
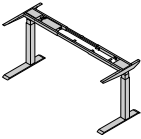
Matching Tabletop Shape	Code	Price
Rectangular	TZ	Priced by Style

Matching Tabletop Size (D x W)	Code	Price
24" x 60"	2460	Priced by Style
24" x 66"	2466	Priced by Style
24" x 72"	2472	Priced by Style
30" x 60"	3060	Priced by Style
30" x 66"	3066	Priced by Style
30" x 72"	3072	Priced by Style

Paint Color	Code	Price
Silver	BF01	+ \$0
White	BF02	+ \$0
Black	BF03	+ \$0

SWITCHBACK BUNDLE

2. Switchback 2-Leg Base (Cont.)

Foot Style	Code	Price
Glides	LS18	+ \$0
Casters	LS19	+ \$109

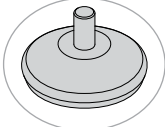
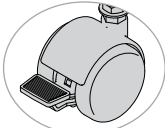
3. Screens

Product Type	Code	Price
Screen	3163	Priced by Size

Screen Material	Code	Price
Frosted Acrylic	DT101	+ \$0
Fabric	DT701	+ \$0
Markerboard	DT301	+ \$0

Screen Size	Code	Price
Frosted Acrylic		
24" x 60"	DS2460	\$569
24" x 66"	DS2466	\$625
24" x 72"	DS2472	\$683
30" x 60"	DS3060	\$711
30" x 66"	DS3066	\$781
30" x 72"	DS3072	\$851
Fabric		
24" x 60"	DS2460	\$593
24" x 66"	DS2466	\$657
24" x 72"	DS2472	\$731
30" x 60"	DS3060	\$717
30" x 66"	DS3066	\$738
30" x 72"	DS3072	\$757
Markerboard		
24" x 60"	DS2460	\$525
24" x 66"	DS2466	\$577
24" x 72"	DS2472	\$629
30" x 60"	DS3060	\$635
30" x 66"	DS3066	\$697
30" x 72"	DS3072	\$761

SWITCHBACK

EFFECTIVE OCTOBER 17, 2022

3. Screens (Cont.)

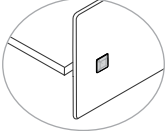
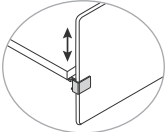
Mount Style	Code	Price	
Midway	MT5	+ \$76	
Height-Adjustable	MT6	+ \$80	

Height-adjustable mount only available with 30" x 60" screen.

4. Wire Management

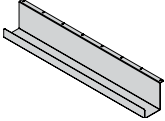
Product Type	Code	Price	
Cable Caddy	3152 WM03	\$178	
Cable Caddy Basket	3152 WM05	\$98	
Cable Caddy Clips	3152 WM01	\$82	
Cable Caddy Slim	3152 WM02	\$64	

5. Power Strip

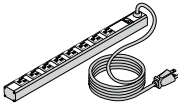
Product Type	Code	Price	
Power Strip	3130 PST1 WM00	\$218	

SWITCHBACK BUNDLE

6. Laptop Tray

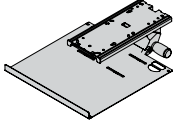
Product Type	Code	Price	
Laptop Tray	3154	Priced by Style	
Mechanism Style	Code	Price	
HAT	KBM01	\$154	
Platform Style	Code	Price	
Laptop Tray	KBP01	+ \$157	
Brackets	Code	Price	
U-Brackets for Crossrails	KBTA	+ \$114	

7. Keyboard Tray

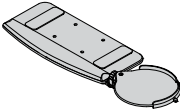
Product Type	Code	Price	
Keyboard Tray	3151	Priced by Style	
Mechanism Style	Code	Price	
Mini Trackless	KBM04	\$330	
Platform Style	Code	Price	
Mini Platform	KBP03	+ \$327	

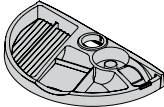

8. Pencil Storage

Product Type	Code	Price	
Half Moon	3155 PDT02	\$125	

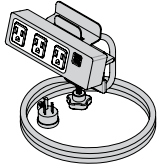

SWITCHBACK

EFFECTIVE OCTOBER 17, 2022

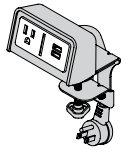
9. Power Module

Product Type	Code	Price	
Power	3130	Priced by Style	
Product Style	Code	Price	
Current With Clamp Mount	PCC	\$278	
EON Clamp On, Dual Outlet	PTC PT5	\$128	
EON Clamp On, Single Outlet, Dual USB	PTC PT2	\$185	
Power Color	Code	Price	
White	PC4	+ \$0	
Black	PC1	+ \$0	

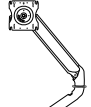
10. Monitor Arm

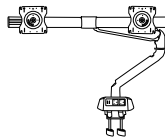
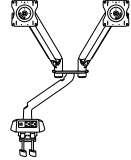
Product Type	Code	Price	
King Cobra Monitor Arm	3101	Priced by Style	
Unity G2 Monitor Arm	3111	Priced by Style	
Mobio Monitor Arm	3210	Priced by Style	
Product Style	Code	Price	
King Cobra			
Single Screen Light Duty	MAT01	\$729	
Single Screen Heavy Duty	MAT02	\$765	
Dual Screen Array Heavy Duty	MAT03	\$852	
Dual Screen High-Splitter Heavy Duty	MAT04	\$1,063	

SWITCHBACK BUNDLE

10. Monitor Arm (Cont.)

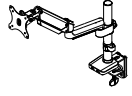
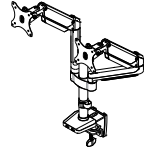
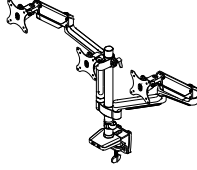
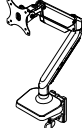
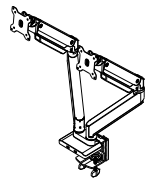
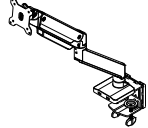
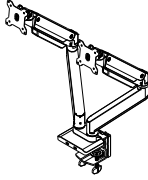
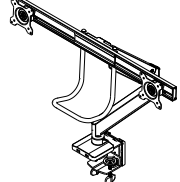
Product Style	Code	Price	
Mobio			
Single Pole	MAT30	\$387	
Dual Pole	MAT31	\$696	
Triple Pole	MAT32	\$807	
Single Desk	MAT33	\$303	
Dual Desk	MAT34	\$605	
Heavy Duty Single Desk	MAT35	\$473	
Heavy Duty Dual Desk	MAT36	\$1,060	
Heavy Duty Dual Array	MAT37	\$702	

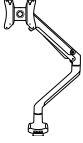
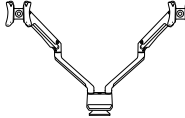

EFFECTIVE OCTOBER 17, 2022

10. Monitor Arm (Cont.)

Product Style	Code	Price	
Unity G2			
Single Monitor Arm	MAT06	\$356	
Dual Monitor Arm	MAT07	\$707	
Paint Color	Code	Price	
Black	MAC03	+ \$0	
Silver	MAC01	+ \$0	
White	MAC02	+ \$0	

King Cobra and Mobio HD monitor arms are available in silver only. Black finish available on Mobio monitor arms only (not available on heavy duty models).

11. Mobile Pedestal

Product Type	Code	Price	
Mobile Pedestal	3150	\$364	
Product Style	Code	Price	
No Upholstered Pad	CPT00	+ \$0	
Upholstered Pad	CPT01	+ \$144	
Paint Color	Code	Price	
Silver	PDC01	+ \$0	
White	PDC02	+ \$0	
Fabric Grade (CPT01 Only)	Code	Price	
Fabric/Vinyl Grade 1	FG1/VG1	+ \$0	
Fabric/Vinyl Grade 2	FG2/VG2	+ \$11	
Fabric/Vinyl Grade 3	FG3/VG3	+ \$30	
Fabric/Vinyl Grade 4	FG4/VG4	+ \$52	
Fabric/Vinyl Grade 5	FG5/VG5	+ \$90	
Fabric/Vinyl Grade 6	FG6/VG6	+ \$127	
Fabric/Vinyl Grade 7	FG7/VG7	+ \$165	

Please reference the [Textile Reference Guide](#) for pricing on fabric over grade 7.

Switchback

2-LEG HEIGHT-ADJUSTABLE TABLE

Find your fit.

Achieving the perfect position maximizes ergonomics and minimizes fatigue or injury. With the press of a button, you can make Switchback height-adjustable table elevate the way you work while ensuring it matches your unique needs. Configure your Switchback with a variety of leg options and an extensive portfolio of tabletop shapes and workstation add-ons. All that and quick installation make Switchback a leading solution in simplicity and endless versatility.



3-Stage T-Leg
Chair sold separately; see [page 69](#) for Focus 2.0

EFFECTIVE OCTOBER 17, 2022

Featured Models

2-STAGE T-LEG :: \$1,198

2-Stage T-leg base, 24" x 60" laminate top, grade 1 laminate, no grommets, glides

3-STAGE T-LEG :: \$1,409

3-Stage T-leg base, 30" x 60" laminate top, grade 1 laminate, no grommets, glides

3-Stage C-leg base, 30" x 72" laminate top, grade 1 laminate, no grommets, glides

3-STAGE C-LEG :: \$1,489

2-LEG HEIGHT-ADJUSTABLE TABLE

TOPS AND BASES ARE SPECIFIED AND SOLD SEPARATELY.

Features

- Gyro anti-collision technology from a patented sensor stops (and retracts) the table when it makes contact with any object
- Push-button controls with four user-customized positions
- Available with T-leg or C-leg options
- Eleven different durable laminate options to fit your style
- Three durable powder-coated metal base finishes in silver, black or white
- Optional grommets for easy and clean setup of electronic devices
- Chicago Code Compliant (3-conductor type cord with grounded 3-prong molded case plug)
- Meets G1 ANSI BIFMA Certification

SPECIFICATIONS

	3161 TBT6/ TBT6C 2-Stage Switchback	3161 TBT8/ TBT7C 3-Stage Switchback
Height Range	27.9"-47.625"	22.6"-48.7"
Foot Length With 24" Wide Tabletop	21.65" (T-Leg) 22.83" (C-Leg)	21.65" (T-Leg) 22.83" (C-Leg)
Foot Length With 30" Wide Tabletop	29.53"	29.53"
Tabletop Thickness	1.125"	1.125"
Adjustment Speed	1.22" Per Second	1.5" Per Second
Standby Power Consumption	<0.1W	<0.1W
Noise	Approximately 39 DB	Approximately 39 DB
Power Cord Length	98.5"	98.5"
Weight Capacity Warranty	220 lb	265 lb

Height range includes 1.125" tabletop.

See the Stand-Alone Tabletop appendix on [page 141](#) for tabletop weights.

TABLETOP FOR 2-LEG BASE

TOPS AND BASES ARE SPECIFIED AND SOLD SEPARATELY.

1. Product

Product Type	Code	Price
Tabletop	3161	Priced by Size

Product Style	Code	Price
For 2-Stage T-Leg Base	TBT6	Priced by Size
For 3-Stage T-Leg Base	TBT7	Priced by Size
For 2-Stage C-Leg Base	TBT6C	Priced by Size
For 3-Stage, C-Leg Base	TBT7C	Priced by Size

2. Finish

Laminate Color	Code	Price
Grade 1		
Ankara Cherry	TL18	Priced by Size
Black	TL19	Priced by Size
Brazilian Walnut	TL20	Priced by Size
Cabinet Maple	TL21	Priced by Size
Driftwood	TL23	Priced by Size
Folkstone Grey	TL24	Priced by Size
Libretti	TL25	Priced by Size
Queenston Oak	TL26	Priced by Size
Sandalwood	TL27	Priced by Size
Walnut Amati	TL28	Priced by Size
White	TL29	Priced by Size
Grade 2		
Classic Linen	TL17	Priced by Size
Colombian Walnut	TL55	Priced by Size
Crisp Linen	TL64	Priced by Size
Designer White	TL66	Priced by Size
Field Elm	TL13	Priced by Size
Frosty White	TL16	Priced by Size
Grey	TL62	Priced by Size
Grey Elm	TL51	Priced by Size
Kingswood Walnut	TL53	Priced by Size
Manitoba	TL56	Priced by Size
Neo Walnut	TL50	Priced by Size
Platinum	TL61	Priced by Size
Portico Teak	TL60	Priced by Size
Skyline Walnut	TL15	Priced by Size
Steel Mesh	TL59	Priced by Size
Tuscan Walnut	TL57	Priced by Size
Uptown Walnut	TL14	Priced by Size
Laminate Grade	Code	Price
Laminate Grade 1	GR1	Priced by Size
Laminate Grade 2	GR2	Priced by Size

3. Shape

Tabletop Shape	Code	Price
Rectangular Tabletop	TZ	Priced by Size

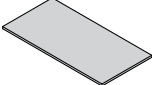

4. Size

Tabletop Size (D x W)	Code	Price
Standard Sizes		
		Grade 1
		Grade 2
24" x 42"	2442	\$229
24" x 48"	2448	\$261
24" x 54"	2454	\$292
24" x 60"	2460	\$324
24" x 66"	2466	\$358
24" x 72"	2472	\$389
24" x 78"	2478	\$421
24" x 84"	2484	\$453
30" x 42"	3042	\$285
30" x 48"	3048	\$324
30" x 54"	3054	\$366
30" x 60"	3060	\$404
30" x 66"	3066	\$445
30" x 72"	3072	\$484
30" x 78"	3078	\$526
30" x 84"	3084	\$565
For Use with eBEAM (-2")		
		Grade 1
		Grade 2
24" x 46"	2446	\$261
24" x 58"	2458	\$324
24" x 70"	2470	\$389
30" x 46"	3046	\$324
30" x 58"	3058	\$404
30" x 70"	3070	\$484

EFFECTIVE OCTOBER 17, 2022 | GSA SIN #: 33721

5. Grommets

Grommet Location	Code	Price
None	GP00	+ \$0
Left	GP01	+ \$30
Center	GP02	+ \$30
Right	GP03	+ \$30
Left and Center	GP04	+ \$60
Left and Right	GP05	+ \$60
Right and Center	GP06	+ \$60
Left, Right and Center	GP07	+ \$90

Grommet Color	Code	Price
Black	GC01	+ \$0
White	GC02	+ \$0

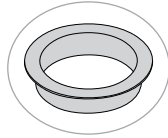

3-Stage C-Leg
Chair sold separately; see [page 176](#) for Wit.

SWITCHBACK

EFFECTIVE OCTOBER 17, 2022 | GSA SIN #: 33721

1. Product

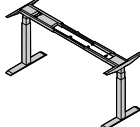
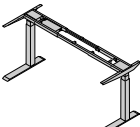
Product Type	Code	Price	
Switchback 2-Leg Base	3162	Priced by Style	
Product Style	Code	Price	
2-Stage T-Leg Base	TBT6	\$874	
3-Stage T-Leg Base	TBT7	\$1,005	
2-Stage C-Leg Base	TBT6C	\$874	
3-Stage C-Leg Base	TBT7C	\$1,005	

2. Base Finish

Paint Color	Code	Price
Silver	BF01	+ \$0
White	BF02	+ \$0
Black	BF03	+ \$0

2-LEG HEIGHT-ADJUSTABLE BASE

TOPS AND BASES ARE SPECIFIED AND SOLD SEPARATELY.

3. Matching Tabletop

Tabletop Shape	Code	Price	
Rectangular Tabletop	TZ	Priced by Size	
Tabletop Size	Code	Price	
Standard Sizes (D x W)			
24" x 42"	2442	+ \$0	
24" x 48"	2448	+ \$0	
24" x 54"	2454	+ \$0	
24" x 60"	2460	+ \$0	
24" x 66"	2466	+ \$0	
24" x 72"	2472	+ \$0	
24" x 78"	2478	+ \$0	
24" x 84"	2484	+ \$0	
30" x 42"	3042	+ \$0	
30" x 48"	3048	+ \$0	
30" x 54"	3054	+ \$0	
30" x 60"	3060	+ \$0	
30" x 66"	3066	+ \$0	
30" x 72"	3072	+ \$0	
30" x 78"	3078	+ \$0	
30" x 84"	3084	+ \$0	
For Use with eBEAM (-2") (D x W)			
24" x 46"	2446	+ \$0	
24" x 58"	2458	+ \$0	
24" x 70"	2470	+ \$0	
30" x 46"	3046	+ \$0	
30" x 58"	3058	+ \$0	
30" x 70"	3070	+ \$0	

Bases require the specification of a tabletop size. Bases take their size from their corresponding tabletop size.

4. Feet

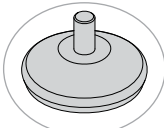
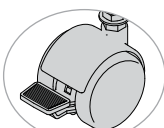
Foot Style	Code	Price	
Glides	LS18	+ \$0	
Casters	LS19	+ \$109	

Switchback

3-LEG HEIGHT-ADJUSTABLE TABLE TYPICALS

Find your fit.

Achieving the perfect position maximizes ergonomics and minimizes fatigue or injury. With the press of a button, you can make the Switchback height-adjustable table elevate the way you work while ensuring it matches your unique needs. Configure your height-adjustable table with a variety of leg options and an extensive portfolio of top shapes and workstation add-ons. All that and quick installation make Switchback a leading solution in simplicity and endless versatility.



T-Shape Collaborative



U-Shape



Pod



Extended Offset U-Shape



Extended Offset Corner With Return

EFFECTIVE OCTOBER 17, 2022 | GSA SIN #: 33721

1. Pod Typical

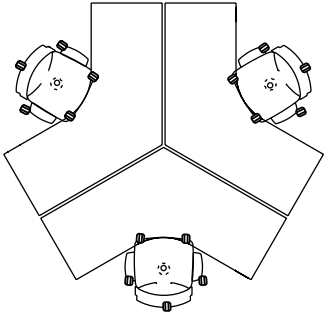
Category	Code	Quantity	Description	List Price	Ext. Price	
Tabletop	3161 TBT8C TA2448 TL27 GR1 GP00	3	120-Degree Tabletop: 24" x 48", Laminate, Grade 1 Laminate, No Grommets	\$908	\$2,724	
Table Base	3162 TBT8C TA2448 BF01	3	3-Leg Base (Pairs With 24" x 48" 120-Degree Tabletop)	\$1,705	\$5,115	

TOTAL: \$7,839

2. U-Shape Typical

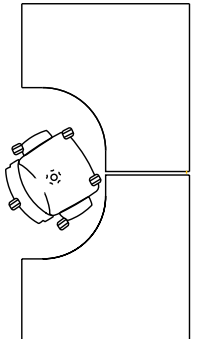
Category	Code	Quantity	Description	List Price	Ext. Price	
Tabletop	3161 TBT8C TBCR2448 TL27 GR1 GP00	1	Right 90-Degree Tabletop: 24" x 48", Grade 1 Laminate, No Grommets	\$517	\$517	
Tabletop	3161 TBT8C TBCL2448 GR1 TL27 GP00	1	Left 90-Degree Tabletop: 24" x 48", Grade 1 Laminate, No Grommets	\$517	\$517	
Table Base	3162 TBT8C TBCL2448 BF01	1	3-Leg Base (Pairs With 24" x 48" 90-Degree Left Tabletop)	\$1,705	\$1,705	
Table Base	3162 TBT8C TBCR2448 BF01	1	3-Leg Base (Pairs With 24" x 48" 90-Degree Right Tabletop)	\$1,705	\$1,705	

TOTAL: \$4,444

3. Extended Offset U-Shape Typical

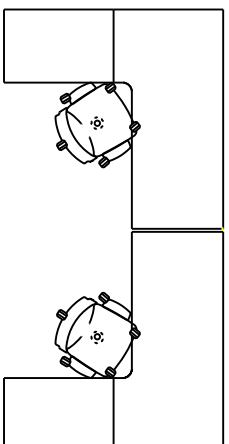
Category	Code	Quantity	Description	List Price	Ext. Price	
Tabletop	3161 TBT8C OR24367230 TL27 GR1 GP00	1	Right Extended Offset Corner Tabletop: 24" x 36" x 72" x 30", Grade 1 Laminate, No Grommets	\$685	\$685	
Tabletop	3161 TBT8C OL30723624 GR1 TL27 GP00	1	Left Extended Offset Corner Tabletop: 30" x 72" x 36" x 24", Grade 1 Laminate, No Grommets	\$685	\$685	
Return Top	3164 TBT8C TN2436 TL27 GR1 GPR00	2	Return Top: 24" x 36", Grade 1 Laminate, No Grommets	\$196	\$392	
Table Base	3162 TBT8C OR24367230 TN2436 BF01	1	3-Leg Base, Cross Beam and Extension Cable (Pairs With 24" x 36" x 72" x 30" Right Extended Offset Corner Tabletop and 24" x 36" Return Top)	\$1,929	\$1,929	
Table Base	3162 TBT8C OL30723624 TN2436 BF01	1	3-Leg Base, Cross Beam and Extension Cable (Pairs With 30" x 72" x 36" x 24" Left Extended Offset Corner Tabletop and 24" x 36" Return Top)	\$1,929	\$1,929	

TOTAL: \$5,620

EFFECTIVE OCTOBER 17, 2022 | GSA SIN #: 33721

4. Extended Offset Corner With Return Typical

Category	Code	Quantity	Description	List Price	Ext. Price	
Tabletop	3161 TBT8C OL30723624 TL27 GR1 GP00	1	Left Extended Offset Corner Tabletop: 24" x 36" x 72" x 30", Laminate, No Grommets	\$685	\$685	
Return Top	3164 TBT8C TN2436 TL27 GR1 GPR00	1	Return Top: 24" x 36", Laminate, No Grommets	\$196	\$196	
Table Base	3162 TBT8C OL30723624 TN2436 BF01	1	3-Leg Base, Cross Beam and Extension Cable (Pairs With 24" x 36" x 72" x 30" Left Extended Corner Tabletop and 24" x 36" Return Top)	\$1,929	\$1,929	

TOTAL: \$2,810

5. T-Shape Collaborative Typical

Category	Code	Quantity	Description	List Price	Ext. Price	
Tabletop	3161 TBT8C TZ3072 TL27 GR1 GP00	2	Rectangular Tabletop: 30" x 72", Laminate, No Grommets	\$484	\$968	
Return Top	3164 TBT8C TN2442 TL27 GR1 GPR00	2	Return Top: 24" x 42", Laminate, No Grommets	\$229	\$458	
Table Base	3162 TBT8C TZ3072 TN2442 BF01	2	3-Leg Base, Cross Beam and Extension Cable (Pairs With 30" x 72" Tabletop and 24" x 42" Return)	\$1,929	\$3,858	

TOTAL: \$5,284

Switchback

3-LEG HEIGHT-ADJUSTABLE TABLE

Find your fit.

Achieving the perfect position maximizes ergonomics and minimizes fatigue or injury. With the press of a button, you can make the Switchback height-adjustable table elevate the way you work while ensuring it matches your unique needs. Configure your Switchback with a variety of leg options and an extensive portfolio of tabletop shapes and workstation add-ons. All that and quick installation make Switchback a leading solution in simplicity and endless versatility.



3-Leg 120-Degree
Chair sold separately;
see [page 174](#) for Vectra

EFFECTIVE OCTOBER 17, 2022

Featured Models

3-LEG 90° :: \$2,350

3-leg base with 24" x 60"
90° corner tabletop, laminate grade 1,
no grommets

3-LEG 120° :: \$2,613

3-leg base with 24" x 48"
120° tabletop, laminate grade 1,
no grommets

3-LEG EXTENDED :: \$2,854

3-leg base with 24" x 48" x 72"
right extended corner tabletop,
24" x 24" return top,
laminate grade 1, no grommets

3-LEG HEIGHT-ADJUSTABLE TABLE

TOPS AND BASES ARE SPECIFIED AND SOLD SEPARATELY.

Features

- Gyro anti-collision technology from a patented sensor stops (and retracts) the table when it makes contact with any object
- Push-button controls with four user-customized positions
- C-leg base
- Eleven different durable laminate options to fit your style
- Three durable powder-coated metal finishes in silver, black or white
- Optional grommets for easy and clean setup of electronic devices
- Chicago Code Compliant (3-conductor type cord with grounded 3-prong molded case plug)
- Meets G1 ANSI BIFMA Certification

SPECIFICATIONS

	C-Leg Switchback
Height Range	22.6"-48.7"
Foot Length With 24" Wide Tabletop	22.83"
Foot Length With 30" Wide Tabletop	29.53"
Tabletop Thickness	1.125"
Adjustment Speed	1.5" Per Second
Standby Power Consumption	<0.1W
Noise	Approximately 39 DB
Power Cord Length	98.5"
Weight Capacity Warranty	265 lb

Height range includes 1.125" tabletop.

See the Stand-Alone Tabletop appendix on [page 141](#) for tabletop weights.

1. Product

Product Type	Code	Price
Tabletop	3161	Priced by Size
Product Style	Code	Price
For Switchback 3-Leg 3-Stage C-Leg Base	TBT8C	Priced by Size

2. Finish

Laminate Color	Code	Price
Grade 1 Laminate		
Ankara Cherry	TL18	Priced by Size
Black	TL19	Priced by Size
Brazilian Walnut	TL20	Priced by Size
Cabinet Maple	TL21	Priced by Size
Driftwood	TL23	Priced by Size
Folkstone Grey	TL24	Priced by Size
Libretti	TL25	Priced by Size
Queenston Oak	TL26	Priced by Size
Sandalwood	TL27	Priced by Size
Walnut Amati	TL28	Priced by Size
White	TL29	Priced by Size
Grade 2 Laminate		
Classic Linen	TL17	Priced by Size
Colombian Walnut	TL55	Priced by Size
Crisp Linen	TL64	Priced by Size
Designer White	TL66	Priced by Size
Field Elm	TL13	Priced by Size
Frosty White	TL16	Priced by Size
Grey	TL62	Priced by Size
Grey Elm	TL51	Priced by Size
Kingswood Walnut	TL53	Priced by Size
Manitoba	TL56	Priced by Size
Neo Walnut	TL50	Priced by Size
Platinum	TL61	Priced by Size
Portico Teak	TL60	Priced by Size
Skyline Walnut	TL15	Priced by Size
Steel Mesh	TL59	Priced by Size
Tuscan Walnut	TL57	Priced by Size
Uptown Walnut	TL14	Priced by Size
Laminate Grade	Code	Price
Laminate Grade 1	GR1	Priced by Size
Laminate Grade 2	GR2	Priced by Size

1-PIECE TABLETOP FOR 3-LEG BASE

TOPS AND BASES ARE SPECIFIED AND SOLD SEPARATELY.

3. Shape

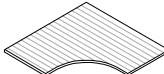
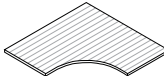
Tabletop Shape	Code	Price	
120-Degree Tabletop	TA	Priced by Size	
Right 90-Degree Tabletop	TBCR	Priced by Size	
Left 90-Degree Tabletop	TBCL	Priced by Size	

4. Size

Tabletop Size	Code	Price	
120-Degree (D x W)		Grade 1	Grade 2
24" x 42"	TA2442	\$705	\$1,058
24" x 48"	TA2448	\$908	\$1,362
30" x 42"	TA3042	\$736	\$1,104
30" x 48"	TA3048	\$917	\$1,376
Right 90-Degree Corner (D x W)		Grade 1	Grade 2
24" x 48"	TBCR2448	\$517	\$776
24" x 54"	TBCR2454	\$582	\$873
24" x 60"	TBCR2460	\$645	\$968
30" x 48"	TBCR3048	\$645	\$968
30" x 54"	TBCR3054	\$729	\$1,094
30" x 60"	TBCR3060	\$805	\$1,208
Left 90-Degree Corner (D x W)		Grade 1	Grade 2
24" x 48"	TBCL2448	\$517	\$776
24" x 54"	TBCL2454	\$582	\$873
24" x 60"	TBCL2460	\$645	\$968
30" x 48"	TBCL3048	\$645	\$968
30" x 54"	TBCL3054	\$729	\$1,094
30" x 60"	TBCL3060	\$805	\$1,208

SWITCHBACK

1-PIECE TABLETOP FOR 3-LEG BASE TOPS AND BASES ARE SPECIFIED AND SOLD SEPARATELY.

EFFECTIVE OCTOBER 17, 2022 | GSA SIN #: 33721

5. Grommets

Grommet Location	Code	Price
None	GP00	+ \$0
Left	GP01	+ \$30
Center	GP02	+ \$30
Right	GP03	+ \$30
Left and Center	GP04	+ \$60
Left and Right	GP05	+ \$60
Right and Center	GP06	+ \$60
Left, Right and Center	GP07	+ \$90

Grommet Color	Code	Price
Black	GC01	+ \$0
White	GC02	+ \$0

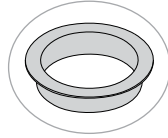

3-Leg 120°
Chair sold separately;
see [page 172](#) for Vectra

1. Product

Product Type	Code	Price
Switchback 3-Leg Base	3162	Priced by Style

Product Style	Code	Price
---------------	------	-------

3-Stage C-Leg Base

TBT8C

\$1,705

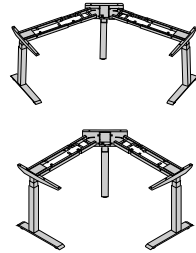

2. Base Finish

Paint Color	Code	Price
Silver	BF01	+ \$0
White	BF02	+ \$0
Black	BF03	+ \$0

3-LEG BASE FOR 1-PIECE TOP

TOPS AND BASES ARE SPECIFIED AND SOLD SEPARATELY.

3. Matching Tabletop

Tabletop Shape	Code	Price
120-Degree Tabletop	TA	Priced by Size
Right 90-Degree Tabletop	TBCR	Priced by Size
Left 90-Degree Tabletop	TBCL	Priced by Size

Tabletop Size	Code	Price
Depth x Width	120-Degree Top	
24" x 42"	2442	+ \$0
24" x 48"	2448	+ \$0
30" x 42"	3042	+ \$0
30" x 48"	3048	+ \$0

Depth x Width	Right 90-Degree Corner Tabletop	
24" x 48"	2448	+ \$0
24" x 54"	2454	+ \$0
24" x 60"	2460	+ \$0
30" x 48"	3048	+ \$0
30" x 54"	3054	+ \$0
30" x 60"	3060	+ \$0

Depth x Width	Left 90-Degree Corner Tabletop	
24" x 48"	2448	+ \$0
24" x 54"	2454	+ \$0
24" x 60"	2460	+ \$0
30" x 48"	3048	+ \$0
30" x 54"	3054	+ \$0
30" x 60"	3060	+ \$0

Bases require the specification of a tabletop size. Bases take their size from their corresponding tabletop size.

SWITCHBACK

EFFECTIVE OCTOBER 17, 2022 | GSA SIN #: 33721

1. Product

Product Type	Code	Price
Switchback Tabletop	3161	Priced by Size

Product Style	Code	Price
For 3-Leg 3-Stage C-Leg Base	TBT8C	Priced by Size

2. Finish

Laminate	Code	Price
Grade 1 Laminate		
Ankara Cherry	TL18	Priced by Size
Black	TL19	Priced by Size
Brazilian Walnut	TL20	Priced by Size
Cabinet Maple	TL21	Priced by Size
Driftwood	TL23	Priced by Size
Folkstone Grey	TL24	Priced by Size
Libretti	TL25	Priced by Size
Queenston Oak	TL26	Priced by Size
Sandalwood	TL27	Priced by Size
Walnut Amati	TL28	Priced by Size
White	TL29	Priced by Size
Grade 2 Laminate		
Classic Linen	TL17	Priced by Size
Colombian Walnut	TL55	Priced by Size
Crisp Linen	TL64	Priced by Size
Designer White	TL66	Priced by Size
Field Elm	TL13	Priced by Size
Frosty White	TL16	Priced by Size
Grey	TL62	Priced by Size
Grey Elm	TL51	Priced by Size
Kingswood Walnut	TL53	Priced by Size
Manitoba	TL56	Priced by Size
Neo Walnut	TL50	Priced by Size
Platinum	TL61	Priced by Size
Portico Teak	TL60	Priced by Size
Skyline Walnut	TL15	Priced by Size
Steel Mesh	TL59	Priced by Size
Tuscan Walnut	TL57	Priced by Size
Uptown Walnut	TL14	Priced by Size

Laminate Grade	Code	Price
Laminate Grade 1	GR1	Priced by Size
Laminate Grade 2	GR2	Priced by Size

TABLETOP FOR 3-LEG BASE AND RETURN

TOPS AND BASES ARE SPECIFIED AND SOLD SEPARATELY.

3. Shape

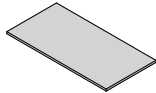
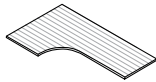
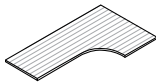
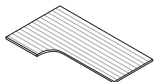
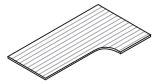
Tabletop Shape	Code	Price	
Rectangular	TZ	Priced by Size	
Right Extended Corner	TXR	Priced by Size	
Left Extended Corner	TXL	Priced by Size	
Right Extended Offset	OR	Priced by Size	
Left Extended Offset	OL	Priced by Size	

4. Size

Tabletop Size	Code	Laminate Price	
Rectangular (D x W)		Grade 1	Grade 2
24" x 48"	2448	\$261	\$392
24" x 54"	2454	\$292	\$438
24" x 60"	2460	\$324	\$486
24" x 66"	2466	\$358	\$537
24" x 72"	2472	\$389	\$584
30" x 48"	3048	\$324	\$486
30" x 54"	3054	\$366	\$549
30" x 60"	3060	\$404	\$606
30" x 66"	3066	\$445	\$668
30" x 72"	3072	\$484	\$726

EFFECTIVE OCTOBER 17, 2022 | GSA SIN #: 33721

4. Size (Cont.)

Tabletop Size (Cont.)	Code	Laminate Price	
Right Extended Corner (A x B x C)		Grade 1	Grade 2
24" x 36" x 60"	243660	\$485	\$728
24" x 36" x 66"	243666	\$547	\$821
24" x 36" x 72"	243672	\$618	\$927
24" x 42" x 60"	244260	\$557	\$836
24" x 42" x 66"	244266	\$629	\$944
24" x 42" x 72"	244272	\$710	\$1,065
24" x 48" x 60"	244860	\$613	\$920
24" x 48" x 66"	244866	\$692	\$1,038
24" x 48" x 72"	244872	\$781	\$1,172
30" x 36" x 60"	303660	\$557	\$836
30" x 36" x 66"	303666	\$629	\$944
30" x 36" x 72"	303672	\$760	\$1,140
30" x 42" x 60"	304260	\$640	\$960
30" x 42" x 66"	304266	\$723	\$1,085
30" x 42" x 72"	304272	\$817	\$1,226
30" x 48" x 60"	304860	\$672	\$1,008
30" x 48" x 66"	304866	\$760	\$1,140
30" x 48" x 72"	304872	\$860	\$1,290
Left Extended Corner (A x B x C)		Grade 1	Grade 2
24" x 60" x 36"	246036	\$485	\$728
24" x 66" x 36"	246636	\$547	\$821
24" x 72" x 36"	247236	\$618	\$927
24" x 60" x 42"	246042	\$557	\$836
24" x 66" x 42"	246642	\$629	\$944
24" x 72" x 42"	247242	\$710	\$1,065
24" x 60" x 48"	246048	\$613	\$920
24" x 66" x 48"	246648	\$692	\$1,038
24" x 72" x 48"	247248	\$781	\$1,172
30" x 60" x 36"	306036	\$557	\$836
30" x 66" x 36"	306636	\$629	\$944
30" x 72" x 36"	307236	\$760	\$1,140
30" x 60" x 42"	306042	\$640	\$960
30" x 66" x 42"	306642	\$723	\$1,085
30" x 72" x 42"	307242	\$817	\$1,226
30" x 60" x 48"	306048	\$672	\$1,008
30" x 66" x 48"	306648	\$760	\$1,140
30" x 72" x 48"	307248	\$860	\$1,290

On extended corner tops, the main desk and return have equal depth. Multipiece tops must be paired with returns.

4. Size (Cont.)

Tabletop Size (Cont.)	Code	Laminate Price	
Right Extended Offset (A x B x C x D)		Grade 1	Grade 2
24" x 36" x 60" x 30"	24366030	\$531	\$797
24" x 36" x 66" x 30"	24366630	\$604	\$906
24" x 36" x 72" x 30"	24367230	\$685	\$1,028
24" x 42" x 60" x 30"	24426030	\$616	\$924
24" x 42" x 66" x 30"	24426630	\$697	\$1,046
24" x 42" x 72" x 30"	24427230	\$793	\$1,190
24" x 48" x 60" x 30"	24486030	\$648	\$972
24" x 48" x 66" x 30"	24486630	\$735	\$1,103
24" x 48" x 72" x 30"	24487230	\$835	\$1,253
Left Extended Offset (A x B x C x D)		Grade 1	Grade 2
30" x 60" x 36" x 24"	30603624	\$531	\$797
30" x 66" x 36" x 24"	30663624	\$604	\$906
30" x 72" x 36" x 24"	30723624	\$685	\$1,028
30" x 60" x 42" x 24"	30604224	\$616	\$924
30" x 66" x 42" x 24"	30664224	\$697	\$1,046
30" x 72" x 42" x 24"	30724224	\$793	\$1,190
30" x 60" x 48" x 24"	30604824	\$648	\$972
30" x 66" x 48" x 24"	30664824	\$735	\$1,103
30" x 72" x 48" x 24"	30724824	\$835	\$1,253

On extended offset corner tops, the main desk has a depth of 30", which tapers down to a depth of 24" on the return. Multipiece tops must be paired with returns.

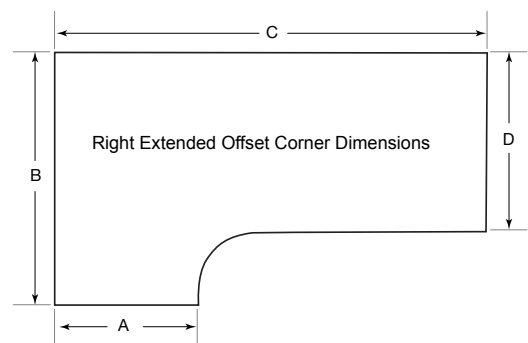
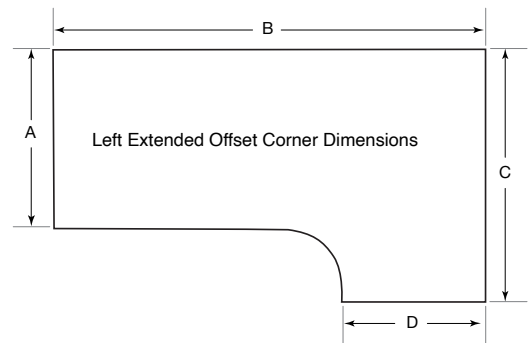

EFFECTIVE OCTOBER 17, 2022 | GSA SIN #: 33721

5. Grommets

Grommet Location	Code	Price
None	GP00	+ \$0
Left	GP01	+ \$30
Center	GP02	+ \$30
Right	GP03	+ \$30
Left and Center	GP04	+ \$60
Left and Right	GP05	+ \$60
Right and Center	GP06	+ \$60
Left, Right and Center	GP07	+ \$90

Grommet Color	Code	Price
Black	GC01	+ \$0
White	GC02	+ \$0

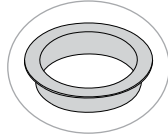

Left grommets (GP01/GP04/GP05/GP07) are not available on right extended corners or right extended offset corners.

Right grommets (GP03/GP05/GP06/GP07) are not available on left extended corners or left extended offset corners.



*3-Leg Extended Corner
Chair sold separately;
see [page 119](#) for Novo.*

1. Product

Product Type	Code	Price
Return Top	3164	Priced by Size
Product Style	Code	Price
For Switchback 3-Leg 3-Stage C-Leg Base	TBT8C	Priced by Size

2. Finish

Laminate	Code	Price
Grade 1 Laminate		
Ankara Cherry	TL18	Priced by Size
Black	TL19	Priced by Size
Brazilian Walnut	TL20	Priced by Size
Cabinet Maple	TL21	Priced by Size
Driftwood	TL23	Priced by Size
Folkstone Grey	TL24	Priced by Size
Libretti	TL25	Priced by Size
Queenston Oak	TL26	Priced by Size
Sandalwood	TL27	Priced by Size
Walnut Amati	TL28	Priced by Size
White	TL29	Priced by Size
Grade 2 Laminate		
Classic Linen	TL17	Priced by Size
Colombian Walnut	TL55	Priced by Size
Crisp Linen	TL64	Priced by Size
Designer White	TL66	Priced by Size
Field Elm	TL13	Priced by Size
Frosty White	TL16	Priced by Size
Grey	TL62	Priced by Size
Grey Elm	TL51	Priced by Size
Kingswood Walnut	TL53	Priced by Size
Manitoba	TL56	Priced by Size
Neo Walnut	TL50	Priced by Size
Platinum	TL61	Priced by Size
Portico Teak	TL60	Priced by Size
Skyline Walnut	TL15	Priced by Size
Steel Mesh	TL59	Priced by Size
Tuscan Walnut	TL57	Priced by Size
Uptown Walnut	TL14	Priced by Size
Laminate Grade	Code	Price
Laminate Grade 1	GR1	Priced by Size
Laminate Grade 2	GR2	Priced by Size

RETURN TOP FOR 3-LEG BASE

TOPS AND BASES ARE SPECIFIED AND SOLD SEPARATELY.

3. Shape

Product Shape	Code	Price
Rectangular Return	TN	Priced by Size

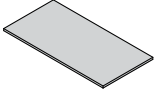

4. Size

Return Top Size	Code	Laminate Price	
Rectangular (D x W)	Code	Grade 1	Grade 2
24" x 24"	2424	\$144	\$216
24" x 30"	2430	\$165	\$248
24" x 36"	2436	\$196	\$294
24" x 42"	2442	\$229	\$344
24" x 48"	2448	\$261	\$392
30" x 24"	3024	\$172	\$258
30" x 30"	3030	\$205	\$308
30" x 36"	3036	\$244	\$366
30" x 42"	3042	\$285	\$428

5. Grommets

Grommet Location	Code	Price
None	GPR00	+ \$0
Left	GPR01	+ \$30
Center	GPR02	+ \$30
Right	GPR03	+ \$30
Grommet Color	Code	Price
Black	GC01	+ \$0
White	GC02	+ \$0

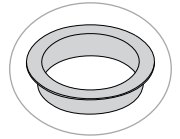

1. Base

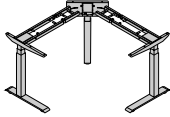
Product Type	Code	Base	
3-Leg 3-Stage C-Leg Base	3162 TBT8C	\$1,705	

2. Finish

Paint Color	Code	Price	
Silver	BF01	+ \$0	
White	BF02	+ \$0	
Black	BF03	+ \$0	

3. Matching Tabletop

Tabletop Shape	Code	Price	
Rectangular	TZ	+ \$0	
Right Extended Corner	TXR	+ \$0	
Left Extended Corner	TXL	+ \$0	
Right Extended Offset	OR	+ \$0	
Left Extended Offset	OL	+ \$0	

Tabletop Size	Code	Price	
Rectangular (D x W)			
24" x 48"	2448	+ \$0	
24" x 54"	2454	+ \$0	
24" x 60"	2460	+ \$0	
24" x 66"	2466	+ \$0	
24" x 72"	2472	+ \$0	
30" x 48"	3048	+ \$0	
30" x 54"	3054	+ \$0	
30" x 60"	3060	+ \$0	
30" x 66"	3066	+ \$0	
30" x 72"	3072	+ \$0	

3-LEG BASE FOR TABLETOP AND RETURN

TOPS AND BASES ARE SPECIFIED AND SOLD SEPARATELY.

3. Matching Tabletop Size (Cont.)

Tabletop Size	Code	Price	
Right Extended Corner (A x B x C)			
24" x 36" x 60"	243660	+ \$0	
24" x 36" x 66"	243666	+ \$0	
24" x 36" x 72"	243672	+ \$0	
24" x 42" x 60"	244260	+ \$0	
24" x 42" x 66"	244266	+ \$0	
24" x 42" x 72"	244272	+ \$0	
24" x 48" x 60"	244860	+ \$0	
24" x 48" x 66"	244866	+ \$0	
24" x 48" x 72"	244872	+ \$0	
30" x 36" x 60"	303660	+ \$0	
30" x 36" x 66"	303666	+ \$0	
30" x 36" x 72"	303672	+ \$0	
30" x 42" x 60"	304260	+ \$0	
30" x 42" x 66"	304266	+ \$0	
30" x 42" x 72"	304272	+ \$0	
30" x 48" x 60"	304860	+ \$0	
30" x 48" x 66"	304866	+ \$0	
30" x 48" x 72"	304872	+ \$0	
Left Extended Corner (A x B x C)			
24" x 60" x 36"	246036	+ \$0	
24" x 66" x 36"	246636	+ \$0	
24" x 72" x 36"	247236	+ \$0	
24" x 60" x 42"	246042	+ \$0	
24" x 66" x 42"	246642	+ \$0	
24" x 72" x 42"	247242	+ \$0	
24" x 60" x 48"	246048	+ \$0	
24" x 66" x 48"	246648	+ \$0	
24" x 72" x 48"	247248	+ \$0	
30" x 60" x 48"	306048	+ \$0	
30" x 66" x 36"	306636	+ \$0	
30" x 72" x 36"	307236	+ \$0	
30" x 60" x 42"	306042	+ \$0	
30" x 66" x 42"	306642	+ \$0	
30" x 72" x 42"	307242	+ \$0	
30" x 60" x 48"	306048	+ \$0	
30" x 66" x 48"	306648	+ \$0	
30" x 72" x 48"	307248	+ \$0	

3-LEG BASE FOR TABLETOP AND RETURN TOPS AND BASES ARE SPECIFIED AND SOLD SEPARATELY.

3. Matching Tabletop Size (Cont.)

Tabletop Size	Code	Price
Right Extended Offset (A x B x C x D)		
24" x 36" x 60" x 30"	24366030	+ \$0
24" x 36" x 66" x 30"	24366630	+ \$0
24" x 36" x 72" x 30"	24367230	+ \$0
24" x 42" x 60" x 30"	24426030	+ \$0
24" x 42" x 66" x 30"	24426630	+ \$0
24" x 42" x 72" x 30"	24427230	+ \$0
24" x 48" x 60" x 30"	24486030	+ \$0
24" x 48" x 66" x 30"	24486630	+ \$0
24" x 48" x 72" x 30"	24487230	+ \$0
Left Extended Offset (A x B x C x D)		
30" x 60" x 36" x 24"	30603624	+ \$0
30" x 66" x 36" x 24"	30663624	+ \$0
30" x 72" x 36" x 24"	30723624	+ \$0
30" x 60" x 42" x 24"	30604224	+ \$0
30" x 66" x 42" x 24"	30664224	+ \$0
30" x 72" x 42" x 24"	30724224	+ \$0
30" x 60" x 48" x 24"	30604824	+ \$0
30" x 66" x 48" x 24"	30664824	+ \$0
30" x 72" x 48" x 24"	30724824	+ \$0

Bases require the specification of a tabletop size. Bases take their size from their corresponding tabletop size.

4. Matching Return

Return Shape	Code	Price
Rectangular Return	TN	Priced by Size
Return Top Size		
No Return	TN0	+ \$0
24" x 24"	TN2424	+ \$74
24" x 30"	TN2430	+ \$74
24" x 36"	TN2436	+ \$74
24" x 42"	TN2442	+ \$74
24" x 48"	TN2448	+ \$74
30" x 24"	TN3024	+ \$74
30" x 30"	TN3030	+ \$74
30" x 36"	TN3036	+ \$74
30" x 42"	TN3042	+ \$74

5. Base Extension

Parts	Code	Price
Cross Beam and Extension Cable	No Code	+ \$150

A base extension charge will be added automatically if the A or D measurement is equal to 72".

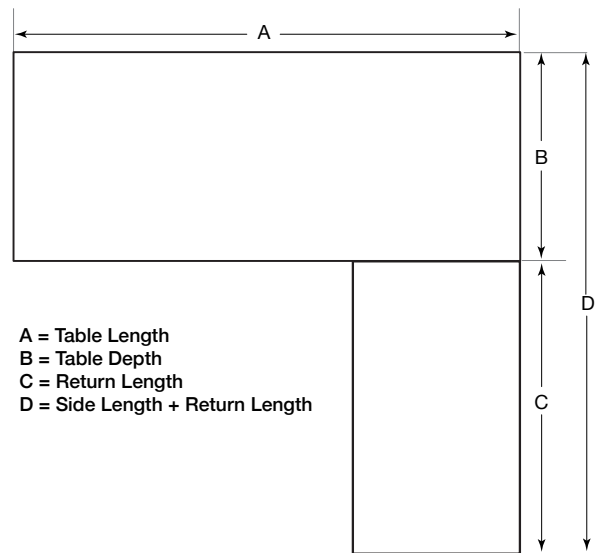
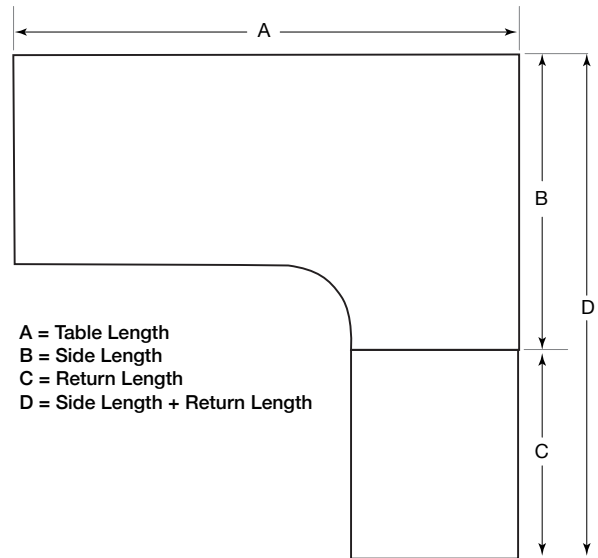

Tensor

CAFÉ, CLASSROOM, AND OFFICE TYPICALS

As your business grows and changes, your workspace should be able to keep up. That's why we created Tensor—one table that can adapt to your changing needs. It's the only table that can expand to support multiple tops on a single base. This allows you to install and reconfigure to fit any space quickly and easily.



L-Shaped With Main and Return



Conference



U-Shaped With Bridge



Multipurpose U-Shape



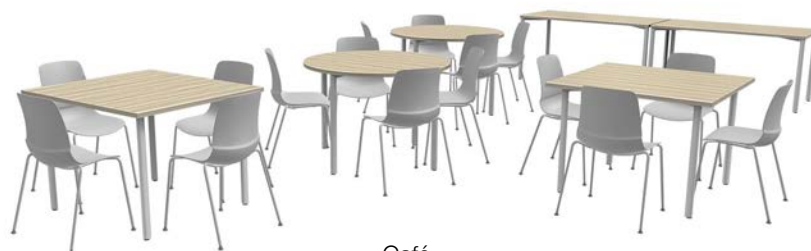

Classroom-Style Training



Café

EFFECTIVE OCTOBER 17, 2022

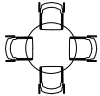
1. Café Typical

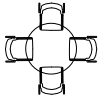
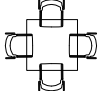
Category	Code	Quantity	Description	List Price	Ext Price	
Tabletop	3231 TBT9 TZ1872 TL27 GP00	2	Rectangular Tabletop: 18" x 72", Laminate, No Grommets	\$300	\$600	
Tabletop	3231 TBT9 TS4242 TL27	2	Square Tabletop: 42" x 42", Laminate	\$385	\$770	
Tabletop	3231 TBT9 TR4242 TL27	2	Round Tabletop: 42" x 42", Laminate	\$385	\$770	
Table Base	3232 TBT9 TZ1872 BF01	2	Base (Pairs With Rectangular 18" x 72" Tabletop)	\$606	\$1,212	
Table Base	3232 TBT9 TS4242 BF01	2	Base (Pairs With 42" x 42" Square Tabletop)	\$533	\$1,066	
Table Base	3232 TBT9 TR4242 BF01	2	Base (Pairs With 42" x 42" Round Tabletop)	\$533	\$1,066	
					TOTAL:	\$5,484

2. Classroom-Style Training Typical

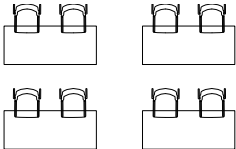
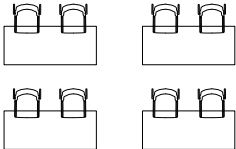
Category	Code	Quantity	Description	List Price	Ext Price	
Tabletop	3231 TBT9 TZ3072 TL24 GP00	8	Rectangular Tabletop: 30" x 72", Laminate, No Grommets	\$484	\$3,872	
Table Base	3232 TBT9 TZ3072 BF01	8	Base (Pairs With 30" x 72" Rectangular Tabletop)	\$606	\$4,848	
					TOTAL:	\$8,720

3. Multipurpose U-Shape Typical

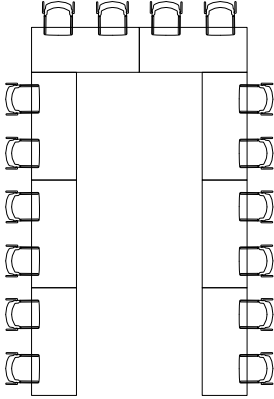
Category	Code	Quantity	Description	List Price	Ext Price	
Tabletop	3231 TBT9 TZ3072 TL22 GP00	8	Rectangular Tabletop: 30" x 72", Laminate, No Grommets	\$484	\$3,872	
Table Base	3232 TBT9 TZ3072 BF01	8	Base (Pairs With 30" x 72" Rectangular Tabletop)	\$606	\$4,848	
Accessories	3159 ATC03 XGV	7	Two Pairs of Ganging Brackets	\$50	\$350	
					TOTAL:	\$9,070

EFFECTIVE OCTOBER 17, 2022

4. Conference Typical

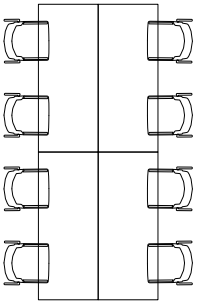
Category	Code	Quantity	Description	List Price	Ext Price	
Tabletop	3231 TBT9 TZ2460 TL27 GP00	4	Rectangular Tabletop: 24" x 60", Laminate, No Grommets	\$324	\$1,296	
Table Base	3232 TBT9 TZ2460 BF01	4	Base (Pairs With 24" x 60" Rectangular Tabletop)	\$580	\$2,320	
Accessories	3159 ATC03 XGV	4	Two Pairs of Ganging Brackets	\$50	\$200	
TOTAL:					\$3,816	

5. L-Shape Typical With Main Desk and Return

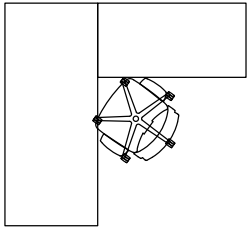
Category	Code	Quantity	Description	List Price	Ext Price	
Tabletop	3231 TBT9 TZ3072 TL27 GP00	1	Rectangular Tabletop: 30" x 72", Laminate, No Grommets	\$484	\$484	
Return Top	3231 TBT9P TN2448 TL27 GPR00	1	Return Top: 24" x 48", Laminate, No Grommets	\$261	\$261	
Table Base	3232 TBT9 TZ3072 BF01	1	Base (Pairs With 30" x 72" Rectangular Tabletop)	\$606	\$606	
Return Base	3232 TBT9P TN2448 BF01	1	Return Base (Pairs With 24" x 48" Return Top)	\$290	\$290	
TOTAL:					\$1,641	

6. U-Shape Typical With Bridge

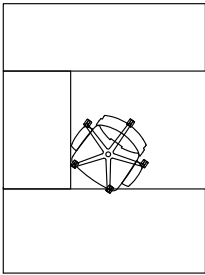
Category	Code	Quantity	Description	List Price	Ext Price	
Desktop	3231 TBT9 TZ3072 TL27 GP00	1	Rectangular Desktop: 30" x 72", Laminate, No Grommets	\$484	\$484	
Credenza Top	3231 TBT9 TZ2472 TL27 GP00	1	Rectangular Credenza Top: 24" x 72", Laminate, No Grommets	\$389	\$389	
Bridgetop	3231 TBT10 TZ2442 TL27	1	Bridgetop: 24" x 42", Laminate	\$229	\$229	
Desk Base	3232 TBT9 TZ3072 BF01	1	Base (Pairs With 30" x 72" Rectangular Tabletop)	\$606	\$606	
Credenza Base	3232 TBT9 TZ2472 BF01	1	Base (Pairs With 24" x 72" Rectangular Tabletop)	\$606	\$606	
Bridge Support	3232 TBT10 TZ2442	1	Mending Brackets (Pairs With 24" x 42" Bridgetop)	\$192	\$192	
TOTAL:					\$2,506	

Tensor

CAFÉ TABLE

One table does it all.

As your business grows and changes, your workspace should be able to keep up. That's why we created Tensor—one table that can adapt to your changing needs. It's the only table that can expand to support multiple top shapes and sizes with a single base. This allows you to install and reconfigure to fit any space quickly and easily.



Round Café Table
Chair sold separately; see [page 34](#) for Baja .

EFFECTIVE OCTOBER 17, 2022

Featured Models

SQUARE :: \$918

42" square tabletop, grade 1 laminate, matching base

ROUND :: \$918

42" round tabletop, grade 1 laminate, matching base

Features

- Patent-pending easy-to-size table support structure adapts to all spaces
- Steel dual-isosceles triangle design evenly distributes and supports weight throughout
- Base accommodates round and square tabletops
Round from 42"–48"; Square from 30"–48"
- Features a minimalistic aesthetic with a below-the-surface configuration
- 28 different durable laminate options to fit your style
- Assembles in less than 10 minutes with pre-installed parts
- 300 lb weight capacity warranty

SPECIFICATIONS

	Tensor Café Table
Height	29.67"
Leg Width	1.8"
Tabletop Thickness	1.125"
Weight Capacity Warranty	300 lb

Height range includes 1.125" tabletop.

See the Stand-Alone Tabletop appendix on page 141 for tabletop weights.

CAFÉ TABLETOP

TOPS AND BASES ARE SPECIFIED AND SOLD SEPARATELY.

1. Product

Product Type	Code	Price
Tabletop	3231 TBT9	Priced by Size

2. Finish

Laminate Color	Code	Price
Grade 1 Laminate		
Ankara Cherry	TL18	Priced by Grade
Black	TL19	Priced by Grade
Brazilian Walnut	TL20	Priced by Grade
Cabinet Maple	TL21	Priced by Grade
Driftwood	TL23	Priced by Grade
Folkstone Grey	TL24	Priced by Grade
Libretti	TL25	Priced by Grade
Queenston Oak	TL26	Priced by Grade
Sandalwood	TL27	Priced by Grade
Walnut Amati	TL28	Priced by Grade
White	TL29	Priced by Grade
Grade 2 Laminate		
Classic Linen	TL17	Priced by Grade
Colombian Walnut	TL55	Priced by Grade
Crisp Linen	TL64	Priced by Grade
Designer White	TL66	Priced by Grade
Field Elm	TL13	Priced by Grade
Frosty White	TL16	Priced by Grade
Grey	TL62	Priced by Grade
Grey Elm	TL51	Priced by Grade
Kingswood Walnut	TL53	Priced by Grade
Manitoba	TL56	Priced by Grade
Neo Walnut	TL50	Priced by Grade
Platinum	TL61	Priced by Grade
Portico Teak	TL60	Priced by Grade
Skyline Walnut	TL15	Priced by Grade
Steel Mesh	TL59	Priced by Grade
Tuscan Walnut	TL57	Priced by Grade
Uptown Walnut	TL14	Priced by Grade
Laminate Grade	Code	Price
Laminate Grade 1	GR1	Priced by Size
Laminate Grade 2	GR2	Priced by Size

EFFECTIVE OCTOBER 17, 2022

3. Shape

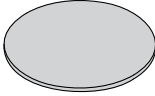
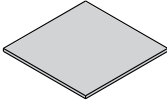
Tabletop Shape	Code	Price	
Round	TR	Priced by Size	
Square	TS	Priced by Size	

Actual size of 30" x 30" tabletop is 30.75" x 30.75".

CAFÉ TABLETOP

TOPS AND BASES ARE SPECIFIED AND SOLD SEPARATELY.

4. Size

Tabletop Size	Code	Price	
Round		Grade 1	Grade 2
42"	4242	\$385	\$578
48"	4848	\$458	\$687
Square		Grade 1	Grade 2
30"	3030	\$297	\$446
36"	3636	\$345	\$518
42"	4242	\$385	\$578
48"	4848	\$458	\$687

Actual size of 30" x 30" tabletop is 30.75" x 30.75".

Square Café Table

Chair sold separately; see page 74 for Mika.



EFFECTIVE OCTOBER 17, 2022

1. Product

Product Type	Code	Price
Base	3232 TBT9	\$533

2. Base Finish

Paint Color	Code	Price
Silver	BF01	+ \$0
White	BF02	+ \$0
Black	BF03	+ \$0

3. Size

Tabletop Size	Code	Price
No Tabletop	TZ0	+ \$0

Round	TR	+ \$0
-------	----	-------

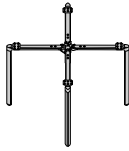

Square	TS	+ \$0
--------	----	-------

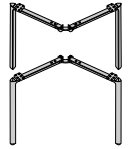

Table bases require the specification of a tabletop size. Bases take their size from their corresponding top size.

CAFÉ TABLE BASE

TOPS AND BASES ARE SPECIFIED AND SOLD SEPARATELY.

4. Size

Tabletop Size	Code	Price
No Tabletop	TZ0	+ \$0
Round		
42"	4242	+ \$0
48"	4848	+ \$0
Square		
30"	3030	+ \$0
36"	3636	+ \$0
42"	4242	+ \$0
48"	4848	+ \$0

Table bases require the specification of a tabletop size. Bases take their size from their corresponding top size.

Tensor

MULTIPURPOSE TABLE

One table does it all.

As your business grows and changes, your workspace should be able to keep up. That's why we created Tensor—one table that can adapt to your changing needs. It's the only table that can expand to support multiple top shapes and sizes with a single base. This allows you to install and reconfigure to fit any space quickly and easily.



24" x 60" Table
Chair sold separately; see [page 65](#) for Ioniq Multipurpose.

EFFECTIVE OCTOBER 17, 2022

Featured Models

18" x 48" :: \$780

18" x 48" tabletop, grade 1 laminate, no grommets, matching base

24" x 60" :: \$904

24" x 60" tabletop, grade 1 laminate, no grommets, matching base

30" x 72" :: \$1,090

30" x 72" tabletop, grade 1 laminate, matching base

Features

- Patent-pending easy-to-size table support structure adapts to all spaces
- Steel dual-isosceles triangle design evenly distributes and supports weight throughout
- Base accommodates tabletops from 18" (D) × 48" (W) to 30" (D) × 72" (W)
- Features a minimalistic aesthetic with a below-the-surface configuration
- 28 different durable laminate options to fit your style
- Installs in less than 10 minutes with pre-installed parts
- 300 lb weight capacity warranty

SPECIFICATIONS

	Tensor Multipurpose
Height	29.67"
Leg Width	1.8"
Tabletop Thickness	1.125"
Weight Capacity Warranty	300 lb

Height range includes 1.125" tabletop.

1. Product

Product Type	Code	Price
Tabletop	3231 TBT9	Priced by Size

2. Finish

Laminate Color	Code	Price
Grade 1 Laminate		
Ankara Cherry	TL18	Priced by Size
Black	TL19	Priced by Size
Brazilian Walnut	TL20	Priced by Size
Cabinet Maple	TL21	Priced by Size
Driftwood	TL23	Priced by Size
Folkstone Grey	TL24	Priced by Size
Libretti	TL25	Priced by Size
Queenston Oak	TL26	Priced by Size
Sandalwood	TL27	Priced by Size
Walnut Amati	TL28	Priced by Size
White	TL29	Priced by Size

MULTIPURPOSE TABLETOP

TOPS AND BASES ARE SPECIFIED AND SOLD SEPARATELY.

2. Finish (Cont.)

Laminate Color	Code	Price
Grade 2 Laminate		
Classic Linen	TL17	Priced by Size
Colombian Walnut	TL55	Priced by Size
Crisp Linen	TL64	Priced by Size
Designer White	TL66	Priced by Size
Field Elm	TL13	Priced by Size
Frosty White	TL16	Priced by Size
Grey	TL62	Priced by Size
Grey Elm	TL51	Priced by Size
Kingswood Walnut	TL53	Priced by Size
Manitoba	TL56	Priced by Size
Neo Walnut	TL50	Priced by Size
Platinum	TL61	Priced by Size
Portico Teak	TL60	Priced by Size
Skyline Walnut	TL15	Priced by Size
Steel Mesh	TL59	Priced by Size
Tuscan Walnut	TL57	Priced by Size
Uptown Walnut	TL14	Priced by Size
Laminate Grade	Code	Price
Laminate Grade 1	GR1	Priced by Size
Laminate Grade 2	GR2	Priced by Size

3. Shape

Tabletop Shape	Code	Price
Rectangular Tabletop	TZ	Priced by Size

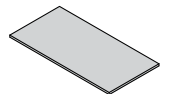

EFFECTIVE OCTOBER 17, 2022

MULTIPURPOSE TABLETOP

TOPS AND BASES ARE SPECIFIED AND SOLD SEPARATELY.

4. Size

Tabletop Size (D x W)	Code	Price	
Rectangular Tabletop		Grade 1	Grade 2
18" x 42"	TZ1842	\$176	\$264
18" x 48"	TZ1848	\$200	\$300
18" x 54"	TZ1854	\$225	\$338
18" x 60"	TZ1860	\$248	\$372
18" x 66"	TZ1866	\$275	\$413
18" x 72"	TZ1872	\$300	\$450
24" x 36"	TZ2436	\$196	\$294
24" x 42"	TZ2442	\$229	\$344
24" x 48"	TZ2448	\$261	\$392
24" x 54"	TZ2454	\$292	\$438
24" x 60"	TZ2460	\$324	\$486
24" x 66"	TZ2466	\$358	\$537
24" x 72"	TZ2472	\$389	\$584
30" x 36"	TZ3036	\$244	\$366
30" x 42"	TZ3042	\$285	\$428
30" x 48"	TZ3048	\$324	\$486
30" x 54"	TZ3054	\$366	\$549
30" x 60"	TZ3060	\$404	\$606
30" x 66"	TZ3066	\$445	\$668
30" x 72"	TZ3072	\$484	\$726

5. Grommets

Grommet Location	Code	Price	
None	GP00	+ \$0	
Left Only	GP01	+ \$30	
Center Only	GP02	+ \$30	
Right Only	GP03	+ \$30	
Left and Center	GP04	+ \$60	
Left and Right	GP05	+ \$60	
Right and Center	GP06	+ \$60	
Left, Right and Center	GP07	+ \$90	

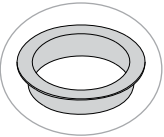

Grommet Color	Code	Price	
Black	GC01	+ \$0	
White	GC02	+ \$0	

EFFECTIVE OCTOBER 17, 2022

1. Product

Product Type	Code	Price
Table Base	3232 TBT9	\$533

3. Base Finish

Paint Color	Code	Price
Silver	BF01	+ \$0
White	BF02	+ \$0
Black	BF03	+ \$0

3. Matching Tabletop

Tabletop Size (D x W)	Code	Price
Rectangular Tabletop	TZ	+ \$0



Tabletop Size (D x W)	Code	Price
18" x 42"	1842	+ \$0
18" x 48"	1848	+ \$47
18" x 54"	1854	+ \$47
18" x 60"	1860	+ \$47
18" x 66"	1866	+ \$47
18" x 72"	1872	+ \$73
24" x 36"	2436	+ \$0
24" x 42"	2442	+ \$0
24" x 48"	2448	+ \$47
24" x 54"	2454	+ \$47
24" x 60"	2460	+ \$47
24" x 66"	2466	+ \$47
24" x 72"	2472	+ \$73
30" x 36"	3036	+ \$0
30" x 42"	3042	+ \$0
30" x 48"	3048	+ \$47
30" x 54"	3054	+ \$47
30" x 60"	3060	+ \$47
30" x 66"	3066	+ \$47
30" x 72"	3072	+ \$73

Table bases require the specification of a tabletop size. Bases take their size from their corresponding top size.

MULTIPURPOSE TABLE BASE

TOPS AND BASES ARE SPECIFIED AND SOLD SEPARATELY.

1. Additional Options (Sold Separately)

Ganging	Code	Price
Two Pairs of Ganging Brackets	3159 XGV	\$50



Tensor

DESKING

One table does it all.

As your business grows and changes, your workspace should be able to keep up. That's why we created Tensor—one table that can adapt to your changing needs. It's the only table that can expand to support multiple top shapes and sizes with a single base. This allows you to install and reconfigure to fit any space quickly and easily.



EFFECTIVE OCTOBER 17, 2022

Featured Models

L-SHAPE DESK :: \$1,641

30" x 72" rectangular desktop, 24" x 48" return top, grade 1 laminate, no grommets, matching bases

U-SHAPE DESK :: \$2,506

30" x 72" desktop, 24" x 72" credenza tops, no grommets, 24" x 42" bridgetop, grade 1 laminate, matching bases and bridge support

Features

- Patent-pending easy-to-size table support structure adapts to all spaces
- Steel dual-isosceles triangle design evenly distributes and supports weight throughout
- Accommodates desktops from 24" x 54"-30" x 72"; credenzas from 18" x 54"-30" x 72"; 24" x 36"-60"
- Features a minimalistic aesthetic with a below-the-surface configuration
- 28 different durable laminate options to fit your style
- Installs in less than 10 minutes with pre-installed parts
- 300 lb weight capacity warranty

SPECIFICATIONS

	Tensor Desking
Height	29.67"
Leg Width	1.8"
Tabletop Thickness	1.125"
Weight Capacity Warranty	300 lb

Height range includes 1.125" tabletop.

See the Stand-Alone Tabletop appendix on [page 141](#) for tabletop weights.



U-Shape Desk
 Chair sold separately;
 see [page 119](#) for Novo.

DESKTOP AND DESK BASE FOR L-SHAPE OR U-SHAPE

TOPS AND BASES ARE SPECIFIED AND SOLD SEPARATELY.

1. Product

Product Type	Code	Price
Desktop	3231 TBT9	Priced by Size

2. Finish

Laminate Color	Code	Price
Grade 1 Laminate		
Ankara Cherry	TL18	Priced by Size
Black	TL19	Priced by Size
Brazilian Walnut	TL20	Priced by Size
Cabinet Maple	TL21	Priced by Size
Driftwood	TL23	Priced by Size
Folkstone Grey	TL24	Priced by Size
Libretti	TL25	Priced by Size
Queenston Oak	TL26	Priced by Size
Sandalwood	TL27	Priced by Size
Walnut Amati	TL28	Priced by Size
White	TL29	Priced by Size
Grade 2 Laminate		
Classic Linen	TL17	Priced by Size
Colombian Walnut	TL55	Priced by Size
Crisp Linen	TL64	Priced by Size
Designer White	TL66	Priced by Size
Field Elm	TL13	Priced by Size
Frosty White	TL16	Priced by Size
Grey	TL62	Priced by Size
Grey Elm	TL51	Priced by Size
Kingswood Walnut	TL53	Priced by Size
Manitoba	TL56	Priced by Size
Neo Walnut	TL50	Priced by Size
Platinum	TL61	Priced by Size
Portico Teak	TL60	Priced by Size
Skyline Walnut	TL15	Priced by Size
Steel Mesh	TL59	Priced by Size
Tuscan Walnut	TL57	Priced by Size
Uptown Walnut	TL14	Priced by Size
Laminate Grade	Code	Price
Laminate Grade 1	GR1	Priced by Size
Laminate Grade 2	GR2	Priced by Size

2. Size

Desktop Size (D x W)	Code	Price
Rectangular Desktop	TZ	Priced by Size

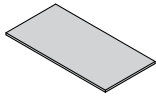

3. Size

Desktop Size (D x W)	Code	Laminate Price	
Rectangular Desktop		Grade 1	Grade 2
24" x 54"	2454	\$292	\$438
24" x 60"	2460	\$324	\$486
24" x 66"	2466	\$358	\$537
24" x 72"	2472	\$389	\$584
30" x 54"	3054	\$366	\$549
30" x 60"	3060	\$404	\$606
30" x 66"	3066	\$445	\$668
30" x 72"	3072	\$484	\$726

4. Grommets

Grommet Location	Code	Price
None	GP00	+ \$0
Left Only	GP01	+ \$30
Center Only	GP02	+ \$30
Right Only	GP03	+ \$30
Left and Center	GP04	+ \$60
Left and Right	GP05	+ \$60
Right and Center	GP06	+ \$60
Left, Right and Center	GP07	+ \$90
Grommet Color	Code	Price
Black	GC01	+ \$0
White	GC02	+ \$0

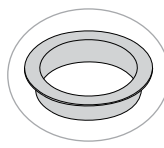

1. Desk Base

Product Type	Code	Price
Base	3232 TBT9	\$533

2. Size

Desktop Size (D x W)	Code	Price
24" x 54"	TZ2454	\$47
24" x 60"	TZ2460	\$47
24" x 66"	TZ2466	\$47
24" x 72"	TZ2472	\$73
30" x 54"	TZ3054	\$47
30" x 60"	TZ3060	\$47
30" x 66"	TZ3066	\$47
30" x 72"	TZ3072	\$73



Desk bases require the specification of a desktop size. Bases take their size from their corresponding top size.

3. Base Finish

Paint Color	Code	Price
Silver	BF01	+ \$0
White	BF02	+ \$0
Black	BF03	+ \$0

1. Product

Product Type	Code	Size
Return Top	3231 TBT9P	Priced by Size

2. Finish

Laminate Color	Code	Price
Grade 1 Laminate		
Ankara Cherry	TL18	Priced by Size
Black	TL19	Priced by Size
Brazilian Walnut	TL20	Priced by Size
Cabinet Maple	TL21	Priced by Size
Driftwood	TL23	Priced by Size
Folkstone Grey	TL24	Priced by Size
Libretti	TL25	Priced by Size
Queenston Oak	TL26	Priced by Size
Sandalwood	TL27	Priced by Size
Walnut Amati	TL28	Priced by Size
White	TL29	Priced by Size
Grade 2 Laminate		
Classic Linen	TL17	Priced by Size
Colombian Walnut	TL55	Priced by Size
Crisp Linen	TL64	Priced by Size
Designer White	TL66	Priced by Size
Field Elm	TL13	Priced by Size
Frosty White	TL16	Priced by Size
Grey	TL62	Priced by Size
Grey Elm	TL51	Priced by Size
Kingswood Walnut	TL53	Priced by Size
Manitoba	TL56	Priced by Size
Neo Walnut	TL50	Priced by Size
Platinum	TL61	Priced by Size
Portico Teak	TL60	Priced by Size
Skyline Walnut	TL15	Priced by Size
Steel Mesh	TL59	Priced by Size
Tuscan Walnut	TL57	Priced by Size
Uptown Walnut	TL14	Priced by Size
Laminate Grade	Code	Price
Laminate Grade 1	GR1	Priced by Size
Laminate Grade 2	GR2	Priced by Size

RETURN TOP FOR L-SHAPE OR U-SHAPE TOPS AND BASES ARE SPECIFIED AND SOLD SEPARATELY.

3. Shape

Return Top Size (D x W)	Code	Price
Rectangular Return Top	TN	Priced by Size

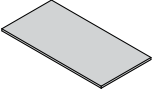

4. Size

Return Top Size (D x W)	Code	Laminate Price	
Rectangular Return Top		Grade 1	Grade 2
24" x 36"	2436	\$196	\$294
24" x 42"	2442	\$229	\$344
24" x 48"	2448	\$261	\$392
24" x 54"	2454	\$292	\$438
24" x 60"	2460	\$324	\$486

5. Grommets

Grommet Location	Code	Price
None	GPR00	+ \$0
Left Only	GPR01	+ \$30
Center Only	GPR02	+ \$30
Right Only	GPR03	+ \$30



Grommet Color	Code	Price
Black	GC01	+ \$0
White	GC02	+ \$0

EFFECTIVE OCTOBER 17, 2022

1. Product

Product Type	Code	Price
Return Base	3232 TBT9P	\$290

2. Size

Return Top Size (D x W)	Code	Price
No Return Top	TN0	+ \$0
24" x 36"	TN2436	+ \$0
24" x 42"	TN2442	+ \$0
24" x 48"	TN2448	+ \$0
24" x 54"	TN2454	+ \$74
24" x 60"	TN2460	+ \$74

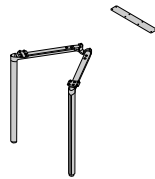

Return bases require the specification of a return top size.

3. Base Finish

Paint Color	Code	Price
Silver	BF01	\$0
White	BF02	\$0
Black	BF03	\$0

EFFECTIVE OCTOBER 17, 2022

1. Product

Product Type	Code	Price
Bridge Top	3231 TBT10	Priced by Size

2. Finish

Laminate Color	Code	Price
Grade 1 Laminate		
Ankara Cherry	TL18	Priced by Size
Black	TL19	Priced by Size
Brazilian Walnut	TL20	Priced by Size
Cabinet Maple	TL21	Priced by Size
Driftwood	TL23	Priced by Size
Folkstone Grey	TL24	Priced by Size
Libretti	TL25	Priced by Size
Queenston Oak	TL26	Priced by Size
Sandalwood	TL27	Priced by Size
Walnut Amati	TL28	Priced by Size
White	TL29	Priced by Size
Grade 2 Laminate		
Classic Linen	TL17	Priced by Size
Colombian Walnut	TL55	Priced by Size
Crisp Linen	TL64	Priced by Size
Designer White	TL66	Priced by Size
Field Elm	TL13	Priced by Size
Frosty White	TL16	Priced by Size
Grey	TL62	Priced by Size
Grey Elm	TL51	Priced by Size
Kingswood Walnut	TL53	Priced by Size
Manitoba	TL56	Priced by Size
Neo Walnut	TL50	Priced by Size
Platinum	TL61	Priced by Size
Portico Teak	TL60	Priced by Size
Skyline Walnut	TL15	Priced by Size
Steel Mesh	TL59	Priced by Size
Tuscan Walnut	TL57	Priced by Size
Uptown Walnut	TL14	Priced by Size
Laminate Grade	Code	Price
Laminate Grade 1	GR1	Priced by Size
Laminate Grade 2	GR2	Priced by Size

BRIDGE TOP FOR U-SHAPE

TOPS AND BASES ARE SPECIFIED AND SOLD SEPARATELY.

3. Shape

Return Top Size (D x W)	Code	Price
Rectangular Bridge Top	TZ	Priced by Size

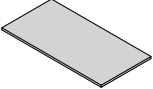

4. Size

Bridgetop Size (D x W)	Code	Price	
Rectangular Bridge Top		Grade 1	Grade 2
24" x 36"	2436	\$196	\$294
24" x 42"	2442	\$229	\$344
24" x 48"	2448	\$261	\$392
24" x 54"	2454	\$292	\$438
24" x 60"	2460	\$324	\$486

EFFECTIVE OCTOBER 17, 2022

1. Product

Product Type	Code	Price
Bridge Support (Mending Brackets)	3232 TBT10	Priced by Size

2. Size

Bridge Top Shape	Code	Price
Rectangular Bridge Top	TZ	\$0

Bridge Top Size (D x W)	Code	Price
No Bridge Top	TN0	\$0
24" x 36"	2436	\$192
24" x 42"	2442	\$192
24" x 48"	2448	\$192
24" x 54"	2454	\$294
24" x 60"	2460	\$294

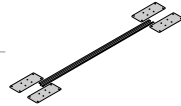

Support includes two sets of mending brackets for all bridge sizes. 54" and 60" table widths also include stiffener.

Bridge supports require the specification of a bridge top size.

EFFECTIVE OCTOBER 17, 2022

1. Product

Product Type	Code	Price
Credenza Top	3231 TBT9	Priced by Size

2. Finish

Laminate Color	Code	Price
Grade 1 Laminate		
Ankara Cherry	TL18	Priced by Size
Black	TL19	Priced by Size
Brazilian Walnut	TL20	Priced by Size
Cabinet Maple	TL21	Priced by Size
Driftwood	TL23	Priced by Size
Folkstone Grey	TL24	Priced by Size
Libretti	TL25	Priced by Size
Queenston Oak	TL26	Priced by Size
Sandalwood	TL27	Priced by Size
Walnut Amati	TL28	Priced by Size
White	TL29	Priced by Size
Grade 2 Laminate		
Classic Linen	TL17	Priced by Size
Colombian Walnut	TL55	Priced by Size
Crisp Linen	TL64	Priced by Size
Designer White	TL66	Priced by Size
Field Elm	TL13	Priced by Size
Frosty White	TL16	Priced by Size
Grey	TL62	Priced by Size
Grey Elm	TL51	Priced by Size
Kingswood Walnut	TL53	Priced by Size
Manitoba	TL56	Priced by Size
Neo Walnut	TL50	Priced by Size
Platinum	TL61	Priced by Size
Portico Teak	TL60	Priced by Size
Skyline Walnut	TL15	Priced by Size
Steel Mesh	TL59	Priced by Size
Tuscan Walnut	TL57	Priced by Size
Uptown Walnut	TL14	Priced by Size
Laminate Grade	Code	Price
Laminate Grade 1	GR1	Priced by Size
Laminate Grade 2	GR2	Priced by Size

CREENZA TOP FOR U-SHAPE

TOPS AND BASES ARE SPECIFIED AND SOLD SEPARATELY.

3. Shape

Credenza Shape	Code	Price
Rectangular Credenza Top	TZ	Priced by Size

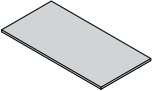

4. Size

Credenza Top Size (D x W)	Code	Laminate Price	
Rectangular Bridge Top		Grade 1	Grade 2
18" x 54"	1854	\$225	\$338
18" x 60"	1860	\$248	\$372
18" x 66"	1866	\$275	\$413
18" x 72"	1872	\$300	\$450
24" x 54"	2454	\$292	\$438
24" x 60"	2460	\$324	\$486
24" x 66"	2466	\$358	\$537
24" x 72"	2472	\$389	\$584
30" x 54"	3054	\$366	\$549
30" x 60"	3060	\$404	\$606
30" x 66"	3066	\$445	\$668
30" x 72"	3072	\$484	\$726

5. Grommets

Grommet Location	Code	Price
No Grommets	GP00	+ \$0
Left Only	GP01	+ \$30
Center Only	GP02	+ \$30
Right Only	GP03	+ \$30
Left and Center	GP04	+ \$60
Left and Right	GP05	+ \$60
Right and Center	GP06	+ \$60
Left, Right and Center	GP07	+ \$90
Grommet Color	Code	Price
Black	GC01	+ \$0
White	GC02	+ \$0

EFFECTIVE OCTOBER 17, 2022

1. Product

Product Type	Code	Price
Credenza Base	3232 TBT9	\$533

2. Base Finish

Paint Color	Code	Price
Silver	BF01	+ \$0
White	BF02	+ \$0
Black	BF03	+ \$0

3. Size

Credenza Top Size (D x W)	Code	Price
18" x 54"	TZ1854	+ \$47
18" x 60"	TZ1860	+ \$47
18" x 66"	TZ1866	+ \$47
18" x 72"	TZ1872	+ \$73
24" x 54"	TZ2454	+ \$47
24" x 60"	TZ2460	+ \$47
24" x 66"	TZ2466	+ \$47
24" x 72"	TZ2472	+ \$73
30" x 54"	TZ3054	+ \$47
30" x 60"	TZ3060	+ \$47
30" x 66"	TZ3066	+ \$47
30" x 72"	TZ3072	+ \$73



Credenza bases require the specification of a credenza top size. Bases take their size from their corresponding top size.

Uni

LAPTOP TABLE

Uni-quely Uni-versal.

Light in weight and not on convenience.

Uni goes anywhere you need it—and with any lounge collection we have. Laptops, notebooks, coffee mugs and more, it's the perfect seating sidekick for your shared and in-between spaces.



EFFECTIVE OCTOBER 17, 2022

Featured Models

CHARCOAL :: \$522

Rectangular laptop table, charcoal base, laminate top

SILVER :: \$522

Rectangular laptop table, charcoal base, laminate top

Features

- Ample surface provides plenty of room to work
- Sleek laminate top features a low-profile knife edge
- Easy-grip finger groove makes moving easy
- Durable base is ultra slim for safer high-traffic areas
- Multi-surface glides enhance mobility while protecting floors
- 100 lb weight capacity warranty

1. Product

Model	Code	Price	
Rectangular Laptop Table	3260 TT9	\$522	

2. Base

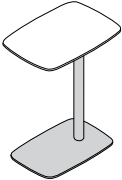
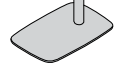
Base Color	Code	Price	
Charcoal	BF04	+ \$0	
Silver	BF01	+ \$0	

3. Table Top

Material	Code	Price	
Laminate	TM3	+ \$0	
Material	Code	Price	
Field Elm	TL13	+ \$0	
Uptown Walnut	TL14	+ \$0	
Skyline Walnut	TL15	+ \$0	
Frosty White	TL16	+ \$0	

LAPTOP TABLE

4. Packaging

Packaging	Code	Price	
Final Assembly Required	P3	+ \$0	

SPECIFICATIONS

Model: 3260 TT9 Laptop Table	
Dimensions	
Overall Height	25.5"
Tabletop Depth	14"
Tabletop Width	20"
Tabletop Thickness	0.75"
Base Depth	11.6"
Base Width	17.6"
Base Thickness	0.25"
Weight and Capacity	
Weight	23.63 lb
Weight Capacity Warranty	100 lb



Charcoal

Benching

FIXED | SINGLE-SIDED | BACK-TO-BACK

HiQ

HEIGHT-ADJUSTABLE BENCHING

Elevate your spaces—literally

HiQ™ is our brand-new height-adjustable total benching solution. This collection lets you take productivity to a higher level with the push of a button, promoting healthier environments through essential ergonomics, connectivity and workspace division. And with a vast lineup of options and add-ons, there's no limit to how you can make it fit anywhere.



6-Seat With Screen
Chairs and storage sold separately.
See [page 119](#) for Novo and [page 40](#) for Mobile pedestal.

EFFECTIVE OCTOBER 17, 2022

Featured Models

BASIC 4-SEAT :: \$7,376

Four seat back-to-back base, 70" x 23" bench tops with no grommets and a grade 1 laminate, vertical wire manager, no end panels, no wire troughs, 72" power infeed, conduit, two duplex receptacles per seat

6-SEAT WITH SCREEN :: \$14,244

Six seat back-to-back base, 70" x 23" bench tops with no grommets and a grade 2 laminate, vertical wire manager, no end panels, no wire troughs, 72" power infeed, conduit, three duplex receptacles per seat, 18" x 72" screens in a grade 2 textile

BENCH TOP

TOPS AND BASES ARE SPECIFIED AND SOLD SEPARATELY.

Features

- Take ergonomics to a new level with push-button height adjustability (28"–47")
- Add a little privacy in shared setups with any Sector or Motif screen as well as optional laminate gallery panels
- Build powerful places of productivity with a robust roster of workstation accessories
- Clear the clutter using cable, data and power management enhancements (beam or trough)
- Customize buildouts to fit your corporate, healthcare and education environments
- Standard control includes four programmable positions and features integrated gyroscopic anti-collision sensor
- Maximize power and data access with up to six duplexes per workstation and capacity for up to 48 CAT6 cables
- Make setup seamless with "above-beam" power and data installation
- Robust steel construction exceeds BIFMA standards for safety and reliability
- UL Certified (UL932)



SPECIFICATIONS

	3291/3292 Height-Adjustable Benching
Total Depth of Benches	50" (24" Top) 62" (30" Top)
Space Between Back-to-Back Benches	4"
Bench Top Thickness	1.125"
Side-to-Side Gap (Mid-Run)	2"
Height Without Bench Top	27.5"–46.4"
Height From Floor to Underside of Crossbeam	17.29"
Distance Between Legs (Width) (Inside-Edge-to-Inside-Edge End)	37.4" (48" Top) 49.4" (60" Top) 61.4" (72" Top)
Distance Between Legs (Width) (Outside-Edge-to-Outside-Edge)	42.9" (48" Top) 54.9" (60" Top) 66.9" (72" Top)
Leg (sq)	2.75"
Crossbeam (H x W)	3.2" x 2.6"
Guage of Steel	12
Active Power Consumption	190–200 W
Standby Power Consumption	0.1 W
Travel Height	19.7"
Speed (Per Second)	1.2"
Weight Capacity (Per Seat)	265 lb



Standard 4-Seat

1. Product

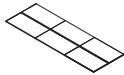
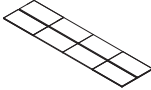
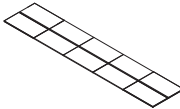
Product Type	Code	Price	
HiQ Bench Top	3291	Priced by Size	
Orientation	Code	Price	
Back-to-Back	BB	Priced by Size	
Seated Positions	Code	Price	
Back-to-Back			
Two Seats	SP2	Priced by Size	
Four Seats	SP4	Priced by Size	
Six Seats	SP6	Priced by Size	
Eight Seats	SP8	Priced by Size	
Ten Seats	SP10	Priced by Size	
Matching Base Style	Code	Price	
2-Stage T-Leg	TBT5	Priced by Size	

2. Finish

Laminate	Code	Price	
Grade 1 Laminate			
Ankara Cherry	TL18	Priced by Size	
Black	TL19	Priced by Size	
Brazilian Walnut	TL20	Priced by Size	
Cabinet Maple	TL21	Priced by Size	
Driftwood	TL23	Priced by Size	
Folkstone Grey	TL24	Priced by Size	
Libretti	TL25	Priced by Size	
Queenston Oak	TL26	Priced by Size	
Sandalwood	TL27	Priced by Size	

BENCH TOP

TOPS AND BASES ARE SPECIFIED AND SOLD SEPARATELY.

3. Top Finish

Laminate	Code	Price	
Walnut Amati	TL28	Priced by Size	
White	TL29	Priced by Size	
Grade 2 Laminate			
Classic Linen	TL17	Priced by Size	
Colombian Walnut	TL55	Priced by Size	
Crisp Linen	TL64	Priced by Size	
Designer White	TL66	Priced by Size	
Field Elm	TL13	Priced by Size	
Frosty White	TL16	Priced by Size	
Grey	TL62	Priced by Size	
Grey Elm	TL51	Priced by Size	
Kingswood Walnut	TL53	Priced by Size	
Manitoba	TL56	Priced by Size	
Neo Walnut	TL50	Priced by Size	
Platinum	TL61	Priced by Size	
Portico Teak	TL60	Priced by Size	
Skyline Walnut	TL15	Priced by Size	
Steel Mesh	TL59	Priced by Size	
Tuscan Walnut	TL57	Priced by Size	
Uptown Walnut	TL14	Priced by Size	
Laminate Grade	Code	Price	
Laminate Grade 1	GR1	Priced by Size	
Laminate Grade 2	GR2	Priced by Size	

3. Shape

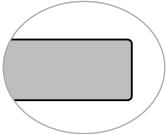
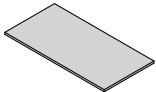
Edge Style	Code	Price	
Flat Edge	TE5	Priced by Size	
Bench Top Shape	Code	Price	
Rectangular Bench Top	TZ	Priced by Size	

4. Size

Depth x Width	Code	Laminate Price	
Two Seat (BB)		Grade 1	Grade 2
23" x 46"	2346	\$522	\$784
23" x 58"	2358	\$648	\$972
23" x 70"	2370	\$778	\$1,168
29" x 46"	2946	\$648	\$972
29" x 58"	2958	\$808	\$1,212
29" x 70"	2970	\$968	\$1,452
Four Seats (BB)		Grade 1	Grade 2
23" x 46"	2346	\$1,044	\$1,568
23" x 58"	2358	\$1,296	\$1,944
23" x 70"	2370	\$1,556	\$2,336
29" x 46"	2946	\$1,296	\$1,944
29" x 58"	2958	\$1,616	\$2,424
29" x 70"	2970	\$1,936	\$2,904
Six Seats (BB)		Grade 1	Grade 2
23" x 46"	2346	\$1,566	\$2,352
23" x 58"	2358	\$1,944	\$2,916
23" x 70"	2370	\$2,334	\$3,504
29" x 46"	2946	\$1,944	\$2,916
29" x 58"	2958	\$2,424	\$3,636
29" x 70"	2970	\$2,904	\$4,356
Eight Seats (BB)		Grade 1	Grade 2
23" x 46"	2346	\$2,088	\$3,136
23" x 58"	2358	\$2,592	\$3,888
23" x 70"	2370	\$3,112	\$4,672
29" x 46"	2946	\$2,592	\$3,888
29" x 58"	2958	\$3,232	\$4,848
29" x 70"	2970	\$3,872	\$5,808
Ten Seats (BB)		Grade 1	Grade 2
23" x 46"	2346	\$2,610	\$3,920
23" x 58"	2358	\$3,240	\$4,860
23" x 70"	2370	\$3,890	\$5,840
29" x 46"	2946	\$3,240	\$4,860
29" x 58"	2958	\$4,040	\$6,060
29" x 70"	2970	\$4,840	\$7,260



BENCH TOP

TOPS AND BASES ARE SPECIFIED AND SOLD SEPARATELY.

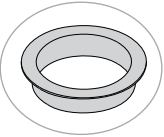
5. Grommets

Grommet Location	Code	Price	
None	GP00	+ \$0	
Two Seat (BB)			
Left	GP01	+ \$60	
Right	GP03	+ \$60	
Left and Right	GP05	+ \$120	
Four Seats (BB)			
Left	GP01	+ \$120	
Right	GP03	+ \$120	
Left and Right	GP05	+ \$240	
Six Seats (BB)			
Left	GP01	+ \$180	
Right	GP03	+ \$180	
Left and Right	GP05	+ \$360	
Eight Seats (BB)			
Left	GP01	+ \$240	
Right	GP03	+ \$240	
Left and Right	GP05	+ \$480	
Ten Seats (BB)			
Left	GP01	+ \$300	
Right	GP03	+ \$300	
Left and Right	GP05	+ \$600	
Grommet Color	Code	Price	
Black	GC01	+ \$0	
White	GC02	+ \$0	

1. Product

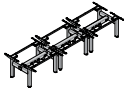
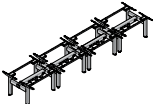
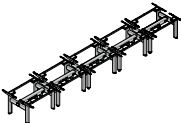
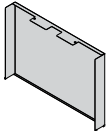
Product Type	Code	Price	
HA Bench Bases	3292	Priced by Style	
Orientation	Code	Price	
Back-to-Back	BB	Priced by Style	
Seated Postions	Code	Price	
Back-to-Back			
Two Seats	SP2	Priced by Style	
Four Seats	SP4	Priced by Style	
Six Seats	SP6	Priced by Style	
Eight Seats	SP8	Priced by Style	
Ten Seats	SP10	Priced by Style	
Base Style	Code	Price	
2-Stage Height-Adjustable			
Two Seats (BB)	TBT5	\$3,210	
Four Seats (BB)	TBT5	\$6,420	
Six Seats (BB)	TBT5	\$9,630	
Eight Seats (BB)	TBT5	\$12,840	
Ten Seats (BB)	TBT5	\$16,050	
Optional Base Components	Code	Price	
No End Panels	FEK00	+ \$0	
End Panel Set	FEK02	+ \$348	

BENCH BASE

TOPS AND BASES ARE SPECIFIED AND SOLD SEPARATELY.

2. Matching Tabletop

Tabletop Shape	Code	Price	
Rectangular	TZ	+ \$0	
Tabletop Size			
23" x 46"	2346	+ \$0	
23" x 58"	2358	+ \$0	
23" x 70"	2370	+ \$0	
29" x 46"	2946	+ \$0	
29" x 58"	2958	+ \$0	
29" x 70"	2970	+ \$0	

Bench bases require the specification of a bench top size. Bases take their size from their corresponding top size.

3. Hand Control

Hand Control Style	Code	Price	
Programmable Controller	HC02	+ \$0	

4. Cable Management

Cable Trough	Code	Price	
Cable Trough	CT00	+\$0	
No Cable Trough, Two Seats (BB)	CT01	- \$300	
No Cable Trough, Four Seats (BB)	CT01	- \$600	
No Cable Trough, Six Seats (BB)	CT01	- \$900	
No Cable Trough, Eight Seats (BB)	CT01	- \$1,200	
No Cable Trough, Ten Seats (BB)	CT01	- \$1,500	

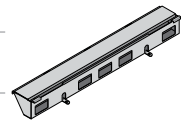

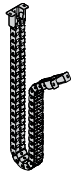
Vertical Wire Manager	Code	Price	
Vertical Wire Manager	VC01 VCC03	+ \$0	
No Vertical Cable Carrier, Two Seats (BB)	VC00	- \$210	
No Vertical Cable Carrier, Four Seats (BB)	VC00	- \$420	
No Vertical Cable Carrier, Six Seats (BB)	VC00	- \$630	
No Vertical Cable Carrier, Eight Seats (BB)	VC00	- \$840	
No Vertical Cable Carrier, Ten Seats (BB)	VC00	- \$1,050	

EFFECTIVE OCTOBER 17, 2022

4. Power

Power Infeed	Code	Price
No Power Infeed	NPIF	- \$147
72" Power Infeed, Conduit	PIC72	+ \$0
72" Power Infeed, Liquidtight	PIL72	+ \$12
144" Power Infeed, Conduit	PIC144	+ \$47
144" Power Infeed, Liquidtight	PIL144	+ \$59

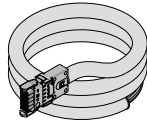

Vertical Cable Carrier	Code	Price
No Duplex		
No Duplex Receptacles, Two Seats (BB)	NDUP	- \$158
No Duplex Receptacles, Four Seats (BB)	NDUP	- \$316
No Duplex Receptacles, Six Seats (BB)	NDUP	- \$474
No Duplex Receptacles, Eight Seats (BB)	NDUP	- \$632
No Duplex Receptacles, Ten Seats (BB)	NDUP	- \$790

Double Duplex		
Double Duplex Receptacles	SDUP	+ \$0

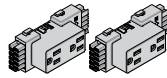

Triple Duplex		
Triple Duplex Receptacles, Two Seats (BB)	SDUP3	+ \$80
Triple Duplex Receptacles, Four Seats (BB)	SDUP3	+ \$160
Triple Duplex Receptacles, Six Seats (BB)	SDUP3	+ \$240
Triple Duplex Receptacles, Eight Seats (BB)	SDUP3	+ \$320
Triple Duplex Receptacles, Ten Seats (BB)	SDUP3	+ \$400

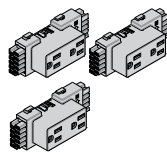

5. Base Finish

Paint Color	Code	Price
Silver	BF01	+ \$0
White	BF02	+ \$0
Black	BF03	+ \$0

SCREENS

1. Product

Product Type	Code	Price
HiQ Center Screen	3293	Priced By Screen Size

2. Matching Benching

Orientation	Code	Price
Back-to-Back	BB	Priced By Screen Size

Seated Positions	Code	Price
Back-to-Back		

Two Seats	SP2	Priced by Screen Size
Four Seats	SP4	Priced by Screen Size
Six Seats	SP6	Priced by Screen Size
Eight Seats	SP8	Priced by Screen Size
Ten Seats	SP10	Priced by Screen Size

Bench Top Size	Code	Price
None	TZ0	Priced by Screen Size
23" x 46"	TZ2346	Priced by Screen Size
23" x 58"	TZ2358	Priced by Screen Size
23" x 70"	TZ2370	Priced by Screen Size
29" x 46"	TZ2946	Priced by Screen Size
29" x 58"	TZ2958	Priced by Screen Size
29" x 70"	TZ2970	Priced by Screen Size

Screens require the specification of a bench top size.

4. Material

Material Type	Code	Price
Markerboard	DT301	Price Below
Fabric/Vinyl	DT701	Priced by Grade

Material Grade	Code	18" (H) Price	24" (H) Price	30" (H) Price	36" (H) Price
48" Wide Side Screens, Two-Seat Back-to-Back		18" x 48"	24" x 48"	30" x 48"	36" x 48"
Markerboard Price		\$316	\$421	\$509	\$636
Fabric/Vinyl Base Price		\$446	\$483	\$610	\$763
Fabric/Vinyl Grade 1	FG1/VG1	+ \$0	+ \$0	+ \$0	+ \$0
Fabric/Vinyl Grade 2	FG2/VG2	+ \$17	+ \$34	+ \$34	+ \$42
Fabric/Vinyl Grade 3	FG3/VG3	+ \$45	+ \$90	+ \$90	+ \$112
Fabric/Vinyl Grade 4	FG4/VG4	+ \$79	+ \$158	+ \$158	+ \$196
Fabric/Vinyl Grade 5	FG5/VG5	+ \$136	+ \$272	+ \$272	+ \$336

3. Size

Screen Size (H" x W")	Code	Price
Two-Seat Back-to-Back		
18" x 48"	DS1848	Priced by Material and Grade
24" x 48"	DS2448	Priced by Material and Grade
30" x 48"	DS3048	Priced by Material and Grade
36" x 48"	DS3648	Priced by Material and Grade
18" x 60"	DS1860	Priced by Material and Grade
24" x 60"	DS2460	Priced by Material and Grade
30" x 60"	DS3060	Priced by Material and Grade
36" x 60"	DS3660	Priced by Material and Grade
18" x 72"	DS1872	Priced by Material and Grade
24" x 72"	DS2472	Priced by Material and Grade
30" x 72"	DS3072	Priced by Material and Grade
36" x 72"	DS3672	Priced by Material and Grade

EFFECTIVE OCTOBER 17, 2022

4. Material (Cont.)

Material Grade	Code	18" (H) Price	24" (H) Price	30" (H) Price	36" (H) Price
48" Wide Side Screens, Four-Seat Back-to-Back		18" x 48"	24" x 48"	30" x 48"	36" x 48"
Markerboard Price		\$632	\$842	\$1,018	\$1,273
Fabric/Vinyl Base Price		\$892	\$966	\$1,220	\$1,525
Fabric/Vinyl Grade 1	FG1/VG1	+ \$0	+ \$0	+ \$0	+ \$0
Fabric/Vinyl Grade 2	FG2/VG2	+ \$34	+ \$68	+ \$68	+ \$84
Fabric/Vinyl Grade 3	FG3/VG3	+ \$90	+ \$180	+ \$180	+ \$224
Fabric/Vinyl Grade 4	FG4/VG4	+ \$158	+ \$316	+ \$316	+ \$392
Fabric/Vinyl Grade 5	FG5/VG5	+ \$272	+ \$544	+ \$544	+ \$672
48" Wide Side Screens, Six-Seat Back-to-Back		18" x 48"	24" x 48"	30" x 48"	36" x 48"
Markerboard Price		\$948	\$1,263	\$1,527	\$1,909
Fabric/Vinyl Base Price		\$1,338	\$1,449	\$1,830	\$2,288
Fabric/Vinyl Grade 1	FG1/VG1	+ \$0	+ \$0	+ \$0	+ \$0
Fabric/Vinyl Grade 2	FG2/VG2	+ \$51	+ \$102	+ \$102	+ \$126
Fabric/Vinyl Grade 3	FG3/VG3	+ \$135	+ \$270	+ \$270	+ \$336
Fabric/Vinyl Grade 4	FG4/VG4	+ \$237	+ \$474	+ \$474	+ \$588
Fabric/Vinyl Grade 5	FG5/VG5	+ \$408	+ \$816	+ \$816	+ \$1,008
48" Wide Side Screens, Eight-Seat Back-to-Back		18" x 48"	24" x 48"	30" x 48"	36" x 48"
Markerboard Price		\$1,264	\$1,684	\$2,036	\$2,545
Fabric/Vinyl Base Price		\$1,784	\$1,932	\$2,440	\$3,050
Fabric/Vinyl Grade 1	FG1/VG1	+ \$0	+ \$0	+ \$0	+ \$0
Fabric/Vinyl Grade 2	FG2/VG2	+ \$68	+ \$136	+ \$136	+ \$168
Fabric/Vinyl Grade 3	FG3/VG3	+ \$180	+ \$360	+ \$360	+ \$448
Fabric/Vinyl Grade 4	FG4/VG4	+ \$316	+ \$632	+ \$632	+ \$784
Fabric/Vinyl Grade 5	FG5/VG5	+ \$544	+ \$1,088	+ \$1,088	+ \$1,344
48" Wide Side Screens, Ten-Seat Back-to-Back		18" x 48"	24" x 48"	30" x 48"	36" x 48"
Markerboard Price		\$1,580	\$2,105	\$2,545	\$3,181
Fabric/Vinyl Base Price		\$2,230	\$2,415	\$3,050	\$3,813
Fabric/Vinyl Grade 1	FG1/VG1	+ \$0	+ \$0	+ \$0	+ \$0
Fabric/Vinyl Grade 2	FG2/VG2	+ \$85	+ \$170	+ \$170	+ \$210
Fabric/Vinyl Grade 3	FG3/VG3	+ \$225	+ \$450	+ \$450	+ \$560
Fabric/Vinyl Grade 4	FG4/VG4	+ \$395	+ \$790	+ \$790	+ \$980
Fabric/Vinyl Grade 5	FG5/VG5	+ \$680	+ \$1,360	+ \$1,360	+ \$5,493
60" Wide Screens, Two-Seat Back-to-Back		18" x 60"	24" x 60"	30" x 60"	36" x 60"
Markerboard Price		\$393	\$525	\$635	\$794
Fabric/Vinyl Base Price		\$502	\$593	\$717	\$896
Fabric/Vinyl Grade 1	FG1/VG1	+ \$0	+ \$0	+ \$0	+ \$0
Fabric/Vinyl Grade 2	FG2/VG2	+ \$21	+ \$42	+ \$50	+ \$50
Fabric/Vinyl Grade 3	FG3/VG3	+ \$56	+ \$112	+ \$133	+ \$133
Fabric/Vinyl Grade 4	FG4/VG4	+ \$98	+ \$196	+ \$233	+ \$233
Fabric/Vinyl Grade 5	FG5/VG5	+ \$168	+ \$336	+ \$400	+ \$400

EFFECTIVE OCTOBER 17, 2022

4. Material (Cont.)

Material Grade	Code	18" (H) Price	24" (H) Price	30" (H) Price	36" (H) Price
60" Wide Screens, Four-Seat Back-to-Back		18" x 60"	24" x 60"	30" x 60"	36" x 60"
Markerboard Price		\$786	\$1,050	\$1,270	\$1,588
Fabric/Vinyl Base Price		\$1,004	\$1,186	\$1,434	\$1,793
Fabric/Vinyl Grade 1	FG1/VG1	+ \$0	+ \$0	+ \$0	+ \$0
Fabric/Vinyl Grade 2	FG2/VG2	+ \$42	+ \$84	+ \$100	+ \$100
Fabric/Vinyl Grade 3	FG3/VG3	+ \$112	+ \$224	+ \$266	+ \$266
Fabric/Vinyl Grade 4	FG4/VG4	+ \$196	+ \$392	+ \$466	+ \$466
Fabric/Vinyl Grade 5	FG5/VG5	+ \$336	+ \$672	+ \$800	+ \$800
60" Wide Screens, Six-Seat Back-to-Back		18" x 60"	24" x 60"	30" x 60"	36" x 60"
Markerboard Price		\$1,179	\$1,575	\$1,905	\$2,381
Fabric/Vinyl Base Price		\$1,506	\$1,779	\$2,151	\$2,689
Fabric/Vinyl Grade 1	FG1/VG1	+ \$0	+ \$0	+ \$0	+ \$0
Fabric/Vinyl Grade 2	FG2/VG2	+ \$63	+ \$126	+ \$150	+ \$150
Fabric/Vinyl Grade 3	FG3/VG3	+ \$168	+ \$336	+ \$399	+ \$399
Fabric/Vinyl Grade 4	FG4/VG4	+ \$294	+ \$588	+ \$699	+ \$699
Fabric/Vinyl Grade 5	FG5/VG5	+ \$504	+ \$1,008	+ \$1,200	+ \$1,200
60" Wide Screens, Eight-Seat Back-to-Back		18" x 60"	24" x 60"	30" x 60"	36" x 60"
Markerboard Price		\$1,572	\$2,100	\$2,540	\$3,175
Fabric/Vinyl Base Price		\$2,008	\$2,372	\$2,868	\$3,585
Fabric/Vinyl Grade 1	FG1/VG1	+ \$0	+ \$0	+ \$0	+ \$0
Fabric/Vinyl Grade 2	FG2/VG2	+ \$84	+ \$168	+ \$200	+ \$200
Fabric/Vinyl Grade 3	FG3/VG3	+ \$224	+ \$448	+ \$532	+ \$532
Fabric/Vinyl Grade 4	FG4/VG4	+ \$392	+ \$784	+ \$932	+ \$932
Fabric/Vinyl Grade 5	FG5/VG5	+ \$672	+ \$1,344	+ \$1,600	+ \$1,600
60" Wide Screens, Ten-Seat Back-to-Back		18" x 60"	24" x 60"	30" x 60"	36" x 60"
Markerboard Price		\$1,965	\$2,625	\$3,175	\$3,969
Fabric/Vinyl Base Price		\$2,510	\$2,965	\$3,585	\$4,481
Fabric/Vinyl Grade 1	FG1/VG1	+ \$0	+ \$0	+ \$0	+ \$0
Fabric/Vinyl Grade 2	FG2/VG2	+ \$105	+ \$210	+ \$250	+ \$250
Fabric/Vinyl Grade 3	FG3/VG3	+ \$280	+ \$560	+ \$665	\$665
Fabric/Vinyl Grade 4	FG4/VG4	+ \$490	+ \$980	+ \$1,165	+ \$1,165
Fabric/Vinyl Grade 5	FG5/VG5	+ \$840	+ \$1,680	+ \$2,000	+ \$2,000
72" Wide Screens, Two-Seat Back-to-Back		18" x 72"	24" x 72"	30" x 72"	36" x 72"
Markerboard Price		\$475	\$629	\$761	\$951
Fabric/Vinyl Base Price		\$565	\$731	\$757	\$946
Fabric/Vinyl Grade 1	FG1/VG1	+ \$0	+ \$0	+ \$0	+ \$0
Fabric/Vinyl Grade 2	FG2/VG2	+ \$25	+ \$50	+ \$50	+ \$50
Fabric/Vinyl Grade 3	FG3/VG3	+ \$66	+ \$133	+ \$133	+ \$133
Fabric/Vinyl Grade 4	FG4/VG4	+ \$116	+ \$233	+ \$233	+ \$233
Fabric/Vinyl Grade 5	FG5/VG5	+ \$200	+ \$400	+ \$400	+ \$400

EFFECTIVE OCTOBER 17, 2022

4. Material (Cont.)

Material Grade	Code	18" (H) Price	24" (H) Price	30" (H) Price	36" (H) Price
72" Wide Screens, Four-Seat Back-to-Back		18" x 72"	24" x 72"	30" x 72"	36" x 72"
Markerboard Price		\$950	\$1,258	\$1,522	\$1,903
Fabric/Vinyl Base Price		\$1,130	\$1,462	\$1,514	\$1,893
Fabric/Vinyl Grade 1	FG1/VG1	+ \$0	+ \$0	+ \$0	+ \$0
Fabric/Vinyl Grade 2	FG2/VG2	+ \$50	+ \$100	+ \$100	+ \$100
Fabric/Vinyl Grade 3	FG3/VG3	+ \$132	+ \$266	+ \$266	+ \$266
Fabric/Vinyl Grade 4	FG4/VG4	+ \$232	+ \$466	+ \$466	+ \$466
Fabric/Vinyl Grade 5	FG5/VG5	+ \$400	+ \$800	+ \$800	+ \$800
72" Wide Screens, Six-Seat Back-to-Back		18" x 72"	24" x 72"	30" x 72"	36" x 72"
Markerboard Price		\$1,425	\$1,887	\$2,283	\$2,854
Fabric/Vinyl Base Price		\$1,695	\$2,193	\$2,271	\$2,839
Fabric/Vinyl Grade 1	FG1/VG1	+ \$0	+ \$0	+ \$0	+ \$0
Fabric/Vinyl Grade 2	FG2/VG2	+ \$75	+ \$150	+ \$150	+ \$150
Fabric/Vinyl Grade 3	FG3/VG3	+ \$198	+ \$399	+ \$399	+ \$399
Fabric/Vinyl Grade 4	FG4/VG4	+ \$348	+ \$699	+ \$699	+ \$699
Fabric/Vinyl Grade 5	FG5/VG5	+ \$600	+ \$1,200	+ \$1,200	+ \$1,200
72" Wide Screens, Eight-Seat Back-to-Back		18" x 72"	24" x 72"	30" x 72"	36" x 72"
Markerboard Price		\$1,900	\$2,516	\$3,044	\$3,805
Fabric/Vinyl Base Price		\$2,260	\$2,924	\$3,028	\$3,785
Fabric/Vinyl Grade 1	FG1/VG1	+ \$0	+ \$0	+ \$0	+ \$0
Fabric/Vinyl Grade 2	FG2/VG2	+ \$100	+ \$200	+ \$200	+ \$200
Fabric/Vinyl Grade 3	FG3/VG3	+ \$264	+ \$532	+ \$532	+ \$532
Fabric/Vinyl Grade 4	FG4/VG4	+ \$464	+ \$932	+ \$932	+ \$932
Fabric/Vinyl Grade 5	FG5/VG5	+ \$800	+ \$1,600	+ \$1,600	+ \$1,600
72" Wide Screens, Ten-Seat Back-to-Back		18" x 72"	24" x 72"	30" x 72"	36" x 72"
Markerboard Price		\$2,375	\$3,145	\$3,805	\$4,756
Fabric/Vinyl Base Price		\$2,825	\$3,655	\$3,785	\$4,731
Fabric/Vinyl Grade 1	FG1/VG1	+ \$0	+ \$0	+ \$0	+ \$0
Fabric/Vinyl Grade 2	FG2/VG2	+ \$125	+ \$250	+ \$250	+ \$250
Fabric/Vinyl Grade 3	FG3/VG3	+ \$330	+ \$665	+ \$665	+ \$665
Fabric/Vinyl Grade 4	FG4/VG4	+ \$580	+ \$1,165	+ \$1,165	+ \$1,165
Fabric/Vinyl Grade 5	FG5/VG5	+ \$1,000	+ \$2,000	+ \$2,000	+ \$2,000

Please reference the [Textile Reference Guide](#) for information on approved textiles for Motif products.

EFFECTIVE OCTOBER 17, 2022

1. Product

Product Category	Code	Price	
Stand-Alone HiQ Accessory	3299	Priced by Size	
Product Type	Code	Price	
Boundary Screen	ATC10	Priced by Size	

2. Size

Screen Size (H x W)	Code	Price	
For Benches Without Center Screens			
29" x 51"	BS2951	\$529	
29" x 63"	BS2963	\$615	
For Benches With 18" Center Screens			
42" x 51"	BS4251	\$675	
42" x 63"	BS4263	\$750	
For Benches With 24" Center Screens			
48" x 51"	BS4851	\$703	
48" x 63"	BS4863	\$825	
For Benches With 30" Center Screens			
54" x 51"	BS5451	\$827	
54" x 63"	BS5463	\$1,021	
For Benches With 36" Center Screens			
60" x 51"	BS6051	\$918	
60" x 63"	BS6063	\$1,134	

*Price is for a single boundary screen, not a pair.***BOUNDARY SCREENS****3. Material**

Screen Material Type	Code	Price	
Laminate	DT501	+ \$0	
Laminate Grade	Code	Price	
Grade 1	GR1	+ \$0	
Laminate Finish	Code	Price	
Ankara Cherry	TL18	+ \$0	
Black	TL19	+ \$0	
Brazilian Walnut	TL20	+ \$0	
Cabinet Maple	TL21	+ \$0	
Driftwood	TL23	+ \$0	
Folkstone Grey	TL24	+ \$0	
Libretti	TL25	+ \$0	
Queenston Oak	TL26	+ \$0	
Sandlewood	TL27	+ \$0	
Walnut Amati	TL28	+ \$0	
White	TL29	+ \$0	

4. Finish

Paint Color for Brackets	Code	Price	
Silver	BF01	+ \$0	
White	BF02	+ \$0	
Black	BF03	+ \$0	

Cable Trough

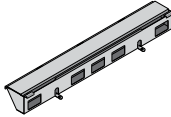
Product Category	Code	Price	Price
Stand-Alone HiQ Accessory	3299	Priced By Product Type	
Product Type	Code	Price	
Single Cable Trough	ATC09 CT01	\$150	
Tabletop Width	Code	Price	
46"	TRL46	+ \$0	
58"	TRL58	+ \$0	
70"	TRL70	+ \$0	
Product Color	Code		Price
Silver	BF01	+ \$0	
White	BF02	+ \$0	
Black	BF03	+ \$0	

Vertical Cable Carrier

Product Category	Code	Price	
Stand-Alone HiQ Accessory	3299	Priced By Product Type	
Product Type	Code	Price	
Vertical Wire Manager	ATC01 VC01	\$105	
Product Color	Code	Price	
Black	VCC03	+ \$0	

STAND-ALONE ACCESSORIES: POWER AND CABLE MANAGEMENT

Duplex Receptacle

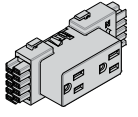
Product Category	Code	Price	
Stand-Alone HiQ Accessory	3299	Priced By Product Type	
Product Type	Code	Price	
Duplex Receptacle	ATC04	\$40	
Circuits	Code	Price	
Circuit 1 (3+1, 2+2)	DC1	+ \$0	
Circuit 2 (3+1, 2+2)	DC2	+ \$0	
Circuit 3 (3+1)	DC3	+ \$0	
Circuit 3 (2+2)	DC3D	+ \$0	
Circuit 4 (3+1, 2+2)	DC4	+ \$0	
Controlled			
Circuit 1 (3+1, 2+2)	DC1C	+ \$7	
Circuit 2 (3+1, 2+2)	DC2C	+ \$7	
Circuit 3 (3+1)	DC3C	+ \$7	
Circuit 3 (2+2)	DC3CD	+ \$7	
Circuit 4 (3+1, 2+2)	DC4C	+ \$7	

Power Infeed

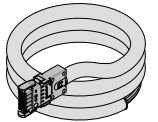
Product Category	Code	Price	
Stand-Alone HiQ Accessory	3299	Priced By Product Type	
Product Type	Code	Price	
Power Infeed	ATC05	Priced by Conduit Style	
Conduit Style	Code	Price	
72" Conduit	PIC72	\$147	
72" Liquidtight	PIL72	\$159	
144" Conduit	PIC144	\$194	
144" Liquidtight	PIL144	\$206	

Power Jumper

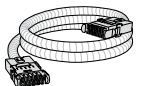
Product Category	Code	Price	
Stand-Alone HiQ Accessory	3299	Priced By Product Type	
Product Type	Code	Price	
Power Jumper	ATC12	Priced by Conduit Style	

Prise

BENCHING TYPICALS

One size really does fit all. Prise is the go-to solution for modular benching, allowing you to build and arrange to fit your workspace. Keep cords, electronics and more all together with standard integrated power trays and slide-out tabletops.



Private Office



Conference



Side-by-Side



Three-Seat



Three-Seat With Screens



Three-Seat With Returns



Six-Seat With Screens



Six-Seat With Returns

EFFECTIVE OCTOBER 17, 2022

1. Side-by-Side Typical

Category	Code	Quantity	Description	List Price	Ext. Price
Bench Top	3021 SS SP2 TZ2472 TL27 GP05 GC02	1	Set of Two Bench Tops: 24" x 72", Grade 1 Laminate, Left and Right Grommets	\$898	\$898
Bench Base	3022 SS SP2 TZ2472 PIW	1	2-Seat Base: Single-Sided, 8-Wire Wall Infeed (Pairs With 24" x 72" Bench Top)	\$2,761	\$2,761
Modesty Screen	3093 MT8 DT501 MPC27 DS1066	2	Modesty Screen: 10" x 66", Grade 1 Laminate	\$338	\$676
Wire Management	3152 WM05	2	Cable Caddy Basket Without Power	\$98	\$196
TOTAL:					\$4,531

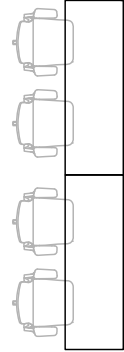

2. Private Office Typical

Category	Code	Quantity	Description	List Price	Ext. Price
Bench Top	3021 SS SP1 TZ3072 TL27 GP00	1	Bench Top: 30" x 72", Grade 1 Laminate, No Grommets	\$484	\$484
Tabletop	3000 TZ2448 TL27 GP00 TTMP1 STF00	1	Rectangular Tabletop: 24" x 48", Grade 1 Laminate, Mending Plate Kit, No Stiffener, No Grommets	\$335	\$335
Tabletop	3000 TZ2472 TL27 GP00 TTMP1 STF00	1	Rectangular Tabletop: 24" x 72", Grade 1 Laminate, Mending Plate Kit, No Stiffener, No Grommets	\$463	\$463
Bench Base	3022 SS SP1 TZ3072 NPOW	1	1-Seat Base: Single-Sided, No Power (Pairs With 30" x 72" Bench Top)	\$1,029	\$1,029
Bench Base	3022 SS SP1 TZ2472 NPOW	1	1-Seat Base: Single-Sided, No Power (Pairs With 24" x 72" Tabletop)	\$1,029	\$1,029
Modesty Screen	3093 MT8 DT501 MPC27 DS1066	1	Modesty Screen: 10" x 66", Grade 1 Laminate	\$338	\$338
Storage	3150 CPT01 PDC02	1	Mobile Pedestal With Upholstered Cushion, Grade 1 Textile	\$508	\$508
TOTAL:					\$4,186

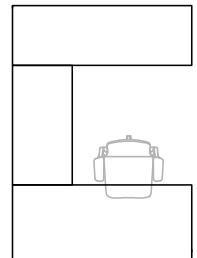

See page 109 to order tabletops.

EFFECTIVE OCTOBER 17, 2022

3. Conference Typical

Category	Code	Quantity	Description	List Price	Ext. Price
Tabletop	3000 TZ4896 TL27 GP00 TTMP0 STF00	1	Rectangular Tabletop: 48" x 96", Grade 1 Laminate, No Grommets, No Stiffener	\$1,152	\$1,152
Bench Base	3022 BB SP2 TZ3066 NPOW	1	2-Seat Base: Back-to-Back, No Power	\$1,617	\$1,617

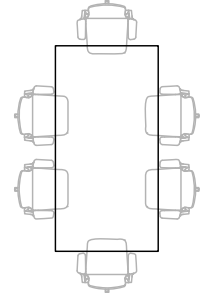

See page 109 to order oversized tabletops.

TOTAL: \$2,769

4. Three Seat Typical

Category	Code	Quantity	Description	List Price	Ext. Price
Bench Top	3021 SS SP3 TZ3060 TL27 GP05 GC02	1	Set of Three Bench Tops: 30" x 60", Grade 1 Laminate, Left and Right Grommets	\$1,392	\$1,392
Bench Base	3022 SS SP3 TZ3060 PIW	1	3-Seat Base: Single-Sided, 8-Wire Wall Infeed (Pairs With 30" x 60" Bench Top)	\$4,018	\$4,018
Modesty Screen	3093 MT8 DT501 MPC27 DS1054	3	Modesty Screen: 10" x 54", Grade 1 Laminate	\$289	\$867
Storage	3150 CPT01 PDC02	3	Mobile Pedestal With Upholstered Cushion, Grade 1 Textile	\$508	\$1,524
Wire Management	3152 WM05	3	Cable Caddy Basket Without Power	\$98	\$294

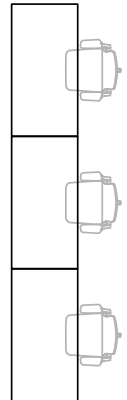

TOTAL: \$8,095

5. Three Seat Typical With Screens

Category	Code	Quantity	Description	List Price	Ext. Price
Bench Top	3021 SS SP3 TZ3060 TL27 GP05 GC02	1	Set of Three Bench Tops: 30" x 60", Grade 1 Laminate, Left and Right Grommets	\$1,392	\$1,392
Bench Base	3022 SS SP3 TZ3060 PIW	1	3-Seat Base: Single Sided, 8-Wire Wall Infeed (Pairs With 30" x 60" Bench Top)	\$4,018	\$4,018
Screen	3090 MT5 DT701 DS3060	3	30" x 60" Screen, Fabric, Grade 1 Textile, Midway Mounts	\$793	\$2,379
Storage	3150 CPT01 PDC02	3	Mobile Pedestal With Upholstered Cushion, Grade 1 Textile	\$508	\$1,524
Wire Management	3152 WM05	3	Cable Caddy Basket Without Power	\$98	\$294

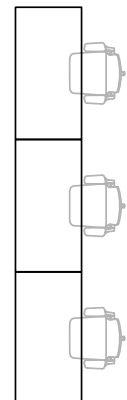

See the screens section starting page page 20 for midway mounts and other screen options

TOTAL: \$9,607

EFFECTIVE OCTOBER 17, 2022

6. Three-Seat Typical With Returns

Category	Code	Quantity	Description	List Price	Ext. Price
Bench Top	3021 SS SP3 TZ3072 TL27 GP05 GC02	1	Set of Three Bench Tops: 30" x 72", Grade 1 Laminate, Left and Right Grommets	\$1,632	\$1,632
Return Top	3024 SS SP3 RP3 TN2448 TL27 GPR00	1	Set of Three Returntops: 24" x 48", Grade 1 Laminate, No Grommets	\$783	\$783
Bench Base	3022 SS SP3 TZ3072 PIW	1	3-Seat Base: Single-Sided, 8-Wire Wall Infeed (Pairs With 30" x 72" Bench Tops)	\$4,018	\$4,018
Return Base	3025 SS SP3 RP3 TN2448	1	Set of Three Return Bases: Single-Sided (Pairs With 24" x 48" Returntops)	\$1,680	\$1,680
Modesty Screen	3093 MT8 DT501 MPC27 DS1066	3	Modesty Screen: 10" x 66", Laminate	\$338	\$1,014
Storage	3150 CPT01 PDC02	3	Mobile Pedestal With Upholstered Cushion, Grade 1 Textile	\$508	\$1,524
Wire Management	3152 WM05	3	Cable Caddy Basket Without Power	\$98	\$294

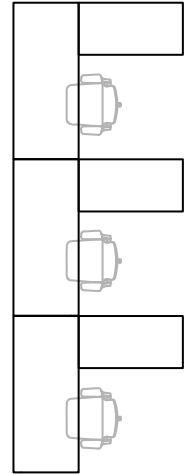

TOTAL: \$10,945

7. Six-Seat Typical With Screens

Category	Code	Quantity	Description	List Price	Ext. Price
Bench Top	3021 BB SP6 TZ3060 TL27 GP05 GC02	1	Set of Six Bench Tops: 30" x 60", Grade 1 Laminate, Left and Right Grommets	\$2,784	\$2,784
Bench Base	3022 BB SP6 TZ3060 PIW	1	6-Seat Base: Back-to-Back, 8-Wire Wall Infeed (Pairs With 30" x 60" Bench Tops)	\$6,068	\$6,068
Screen	3023 BB SP6 TZ3060 DT701 DS1860	1	Set of Three Screens: 18" x 60", Prise Mounts, Fabric, Grade 1 Textile	\$1,506	\$1,506
Storage	3150 CPT01 PDC02	6	Mobile Pedestal With Upholstered Cushion, Grade 1 Textile	\$508	\$3,048

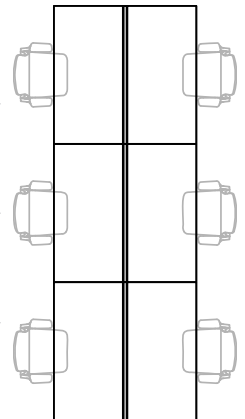

TOTAL: \$13,406

EFFECTIVE OCTOBER 17, 2022

8. Six-Seat Typical With Returns

Category	Code	Quantity	Description	List Price	Ext. Price	
Bench Top	3021 BB SP6 TZ3072 TL27 GP05 GC02	1	Set of Six Bench Tops: 30" x 72", Grade 1 Laminate, Left and Right Grommets	\$3,264	\$3,264	
Return Top	3024 BB SP6 RP6 TN2448 TL27 GPR00	1	Set of Six Returntops: 24" x 48", Grade 1 Laminate, No Grommets	\$1,566	\$1,566	
Bench Base	3022 BB SP6 TZ3072 PIW	1	6-Seat Base: Back-to-Back, 8-Wire Wall Infeed (Pairs With 30" x 72" Bench Tops)	\$6,068	\$6,068	
Return Base	3025 BB SP6 RP6 TN2448	1	Set of Six Return Bases (Pairs With 24" x 48" Returntops)	\$3,360	\$3,360	
Screen	3023 BB SP6 TZ3072 DT701 DS1872	1	Set of Three Screens: 18" x 72", Prise Mounts, Fabric, Grade 1 Textile	\$1,695	\$1,695	
Storage	3150 CPT01 PDC02	6	Mobile Pedestal With Upholstered Cushion, Grade 1 Textile	\$508	\$3,048	

TOTAL: \$19,001

Prise

BENCHING

One size really does fit all. Prise is the go-to solution for modular benching, allowing you to build and arrange to fit your workspace. Keep cords, electronics and more all together with standard integrated power trays and slide-out tabletops.



6-Seat

Chairs not included; see [page 119](#) for Novo.
Storage not included; see [page 40](#) for mobile pedestals.

EFFECTIVE OCTOBER 17, 2022

Featured Models

2-SEAT :: \$4,531

2-seat, single-sided,
24" x 72" bench tops, 10" x 66"
laminated modesty screens, and wire
basket wire management

6-SEAT :: \$13,406

6-seat, back-to-back, 30" x 60" bench
tops with grommets on the left and
right, 18" x 60" fabric screens, mobile
pedestals with upholstered pads

6-SEAT+RETURNS :: \$19,001

6-seat, back-to-back, 30" x 72"
bench tops with grommets on the left
and right, 18" x 72" fabric screens,
24" x 48" returns, mobile pedestals
with upholstered pads

Features

- Steel-frame-constructed bench with standard white base
- Mount screens easily with centered built-in extrusion on bench
- Manage wires with standard integrated power trays and slide-out function for tabletops
- Choose from 11 standard laminate tabletop finishes
- Pick grommets from two colors and specify in multiple locations
- Fixed glides are standard on all models
- Four power ports come standard per bench station; data add-on optional when specified with power
- Provide added convenience with a variety of additional wire management and power options



SPECIFICATIONS

	3021 SS Single-Sided Benching	3021 BB Back-to-Back Benching
Total Depth of Benches	24" 30"	51.44" (24" Top) 63.44" (30" Top)
Space Between Back-to-Back Benches	N/A	3.44"
Gap on Either Side of Center Rail	N/A	1.09"
Bench Top Thickness	1.125"	1.125"
Side-to-Side Gap (Mid Run)	0.125"	0.125"
Height With Bench Top	29.3"	29.3"
Height From Floor to Underside of Base	24.24"	24.24"
Distance Between Legs (Depth) at Base (Inside-Edge-to-Inside-Edge End)	17.52"	40.42"
Distance Between Legs (Depth) at Top	9"	32"
Distance Between Legs at Base (Outside-Edge-to-Outside-Edge)	23.96"	46.85"
Leg Depth	3.17"	3.17"
Leg Width	1.99"	1.99"
Weight Capacity (Per Seat or Return)	200 lb	200 lb

BENCH TOP

TOPS AND BASES ARE SPECIFIED AND SOLD SEPARATELY.

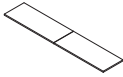
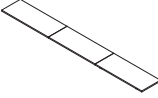
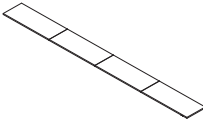
1. Product

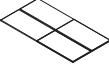
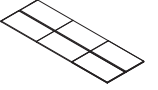
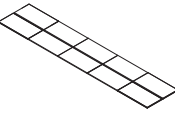
Product Type	Code	Price	
Bench Top	3021	Priced by Size	
Orientation	Code	Price	
Single-Sided	SS	Priced by Size	
Back-to-Back	BB	Priced by Size	
Seated Positions	Code	Price	
Single-Sided			
One Seat	SP1	Priced by Size	
Two Seats	SP2	Priced by Size	
Three Seats	SP3	Priced by Size	
Four Seats	SP4	Priced by Size	
Back-to-Back			
Two Seats	SP2	Priced by Size	
Four Seats	SP4	Priced by Size	
Six Seats	SP6	Priced by Size	
Eight Seats	SP8	Priced by Size	
Matching Base Style	Code	Price	
2-Stage T-Leg	TBT5	Priced by Size	

2. Finish

Laminate	Code	Price
Grade 1 Laminate		
Ankara Cherry	TL18	Priced by Size
Black	TL19	Priced by Size
Brazilian Walnut	TL20	Priced by Size
Cabinet Maple	TL21	Priced by Size
Driftwood	TL23	Priced by Size
Folkstone Grey	TL24	Priced by Size
Libretti	TL25	Priced by Size
Queenston Oak	TL26	Priced by Size
Sandalwood	TL27	Priced by Size
Walnut Amati	TL28	Priced by Size
White	TL29	Priced by Size
Grade 2 Laminate		
Classic Linen	TL17	Priced by Size
Colombian Walnut	TL55	Priced by Size
Crisp Linen	TL64	Priced by Size
Designer White	TL66	Priced by Size
Field Elm	TL13	Priced by Size
Frosty White	TL16	Priced by Size
Grey	TL62	Priced by Size
Grey Elm	TL51	Priced by Size
Kingswood Walnut	TL53	Priced by Size
Manitoba	TL56	Priced by Size
Neo Walnut	TL50	Priced by Size
Platinum	TL61	Priced by Size
Portico Teak	TL60	Priced by Size
Skyline Walnut	TL15	Priced by Size
Steel Mesh	TL59	Priced by Size
Tuscan Walnut	TL57	Priced by Size
Uptown Walnut	TL14	Priced by Size
Laminate Grade	Code	Price
Laminate Grade 1	GR1	Priced by Size
Laminate Grade 2	GR2	Priced by Size

BENCH TOP

TOPS AND BASES ARE SPECIFIED AND SOLD SEPARATELY.

3. Shape

Bench Top Shape	Code	Price
Rectangular Bench Top	TZ	Priced by Size

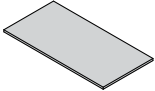

4. Size

Depth x Width	Code	Laminate Price	
One Seat (SS)		Grade 1	Grade 2
24" x 48"	2448	\$261	\$392
24" x 54"	2454	\$292	\$438
24" x 60"	2460	\$324	\$486
24" x 66"	2466	\$358	\$537
24" x 72"	2472	\$389	\$584
30" x 48"	3048	\$324	\$486
30" x 54"	3054	\$366	\$549
30" x 60"	3060	\$404	\$606
30" x 66"	3066	\$445	\$668
30" x 72"	3072	\$484	\$726
Two Seats (SS or BB)		Grade 1	Grade 2
24" x 48"	2448	\$522	\$784
24" x 54"	2454	\$584	\$876
24" x 60"	2460	\$648	\$972
24" x 66"	2466	\$716	\$1,074
24" x 72"	2472	\$778	\$1,168
30" x 48"	3048	\$648	\$972
30" x 54"	3054	\$732	\$1,098
30" x 60"	3060	\$808	\$1,212
30" x 66"	3066	\$890	\$1,336
30" x 72"	3072	\$968	\$1,452
Three Seats (SS)		Grade 1	Grade 2
24" x 48"	2448	\$783	\$1,176
24" x 54"	2454	\$876	\$1,314
24" x 60"	2460	\$972	\$1,458
24" x 66"	2466	\$1,074	\$1,611
24" x 72"	2472	\$1,167	\$1,752
30" x 48"	3048	\$972	\$1,458
30" x 54"	3054	\$1,098	\$1,647
30" x 60"	3060	\$1,212	\$1,818
30" x 66"	3066	\$1,335	\$2,004
30" x 72"	3072	\$1,452	\$2,178

4. Size (Cont.)

Depth x Width	Code	Laminate Price	
		Grade 1	Grade 2
Four Seats (SS or BB)			
24" x 48"	2448	\$1,044	\$1,568
24" x 54"	2454	\$1,168	\$1,752
24" x 60"	2460	\$1,296	\$1,944
24" x 66"	2466	\$1,432	\$2,148
24" x 72"	2472	\$1,556	\$2,336
30" x 48"	3048	\$1,296	\$1,944
30" x 54"	3054	\$1,464	\$2,196
30" x 60"	3060	\$1,616	\$2,424
30" x 66"	3066	\$1,780	\$2,672
30" x 72"	3072	\$1,936	\$2,904
Six Seats (BB)			
24" x 48"	2448	\$1,566	\$2,352
24" x 54"	2454	\$1,752	\$2,628
24" x 60"	2460	\$1,944	\$2,916
24" x 66"	2466	\$2,148	\$3,222
24" x 72"	2472	\$2,334	\$3,504
30" x 48"	3048	\$1,944	\$2,916
30" x 54"	3054	\$2,196	\$3,294
30" x 60"	3060	\$2,424	\$3,636
30" x 66"	3066	\$2,670	\$4,008
30" x 72"	3072	\$2,904	\$4,356
Eight Seats (BB)			
24" x 48"	2448	\$2,088	\$3,136
24" x 54"	2454	\$2,336	\$3,504
24" x 60"	2460	\$2,592	\$3,888
24" x 66"	2466	\$2,864	\$4,296
24" x 72"	2472	\$3,112	\$4,672
30" x 48"	3048	\$2,592	\$3,888
30" x 54"	3054	\$2,928	\$4,392
30" x 60"	3060	\$3,232	\$4,848
30" x 66"	3066	\$3,560	\$5,344
30" x 72"	3072	\$3,872	\$5,808

BENCH TOP





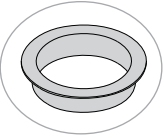

TOPS AND BASES ARE SPECIFIED AND SOLD SEPARATELY.

5. Grommets

Grommet Location	Code	Price	
None	GP00	+ \$0	
One Seat (SS)			
Left	GP01	+ \$30	
Right	GP03	+ \$30	
Left and Right	GP05	+ \$60	
Two Seats (SS or BB)			
Left	GP01	+ \$60	
Right	GP03	+ \$60	
Left and Right	GP05	+ \$120	
Three Seats (SS)			
Left	GP01	+ \$90	
Right	GP03	+ \$90	
Left and Right	GP05	+ \$180	
Four Seats (SS or BB)			
Left	GP01	+ \$120	
Right	GP03	+ \$120	
Left and Right	GP05	+ \$240	
Six Seats (BB)			
Left	GP01	+ \$180	
Right	GP03	+ \$180	
Left and Right	GP05	+ \$360	
Eight Seats (BB)			
Left	GP01	+ \$240	
Right	GP03	+ \$240	
Left and Right	GP05	+ \$480	
Grommet Color	Code	Price	
Black	GC01	+ \$0	
White	GC02	+ \$0	

EFFECTIVE OCTOBER 17, 2022

1. Product

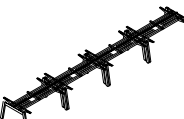
Product Type	Code	Price	
Bench Bases	3022	Priced by Seated Positions	
Product Style	Code	Price	
2-Stage T-Leg	TBT5	Priced by Seated Positions	
Orientation	Code	Price	
Single-Sided	SS	Priced by Seated Positions	
Back-to-Back	BB	Priced by Seated Positions	
Seated Postions	Code	Price	
Single-Sided			
1-Seat	SP1	\$1,029	
2-Seat	SP2	\$1,830	
3-Seat	SP3	\$2,631	
4- Seat	SP4	\$3,431	
Back-to-Back			
2-Seat	SP2	\$1,617	
4-Seat	SP4	\$2,773	
6-Seat	SP6	\$3,930	
8-Seat	SP8	\$5,086	

BENCH BASE

TOPS AND BASES ARE SPECIFIED AND SOLD SEPARATELY.

2. Matching Tabletop

Tabletop Shape	Code	Price	
Rectangular	TZ	+ \$0	
Tabletop Size			
No Top	0	+ \$0	
24" x 48"	2448	+ \$0	
24" x 54"	2454	+ \$0	
24" x 60"	2460	+ \$0	
24" x 66"	2466	+ \$0	
24" x 72"	2472	+ \$0	
30" x 48"	3048	+ \$0	
30" x 54"	3054	+ \$0	
30" x 60"	3060	+ \$0	
30" x 66"	3066	+ \$0	
30" x 72"	3072	+ \$0	

Bench bases require the specification of a bench top size. Bases take their size from their corresponding top size.

3. Power

Power Type	Code	Price	
No Power Pack	NPOW	+ \$0	
Single-Sided, 8-Wire Wall Infeed			
One Seat	PIW	+ \$477	
Two Seats	PIW	+ \$931	
Three Seats	PIW	+ \$1,387	
Four Seats	PIW	+ \$1,844	
Single-Sided, 8-Wire Ceiling Infeed			
One Seat	PIC	+ \$506	
Two Seats	PIC	+ \$962	
Three Seats	PIC	+ \$1,421	
Four Seats	PIC	+ \$1,876	
Back-to-Back, 8-Wire Wall Infeed			
Two Seats	PIW	+ \$725	
Four Seats	PIW	+ \$1,431	
Six Seats	PIW	+ \$2,138	
Eight Seats	PIW	+ \$2,845	
Back-to-Back, 8-Wire Ceiling Infeed			
Two Seats	PIC	+ \$759	
Four Seats	PIC	+ \$1,464	
Six Seats	PIC	+ \$2,170	
Eight Seats	PIC	+ \$2,878	

Infeeds come standard with one dual outlet power module per seat.

EFFECTIVE OCTOBER 17, 2022

1. Return Top

Product Type	Code	Price
Return Top	3024	Priced by Size
Orientation	Code	Price
Single-Sided	SS	Priced by Size
Back-to-Back	BB	Priced by Size
Seated Postions	Code	Price
Single-Sided		
One Seat	SP1	Priced by Size
Two Seats	SP2	Priced by Size
Three Seats	SP3	Priced by Size
Four Seats	SP4	Priced by Size
Back-to-Back		
Two Seats	SP2	Priced by Size
Four Seats	SP4	Priced by Size
Six Seats	SP6	Priced by Size
Eight Seats	SP8	Priced by Size
Return Quantity	Code	Price
One	RP1	Priced by Size
Two	RP2	Priced by Size
Three	RP3	Priced by Size
Four	RP4	Priced by Size
Five	RP5	Priced by Size
Six	RP6	Priced by Size
Seven	RP7	Priced by Size
Eight	RP8	Priced by Size

RETURN TOP

TOPS AND BASES ARE SPECIFIED AND SOLD SEPARATELY.

2. Finish

Laminate	Code	Price
Grade 1 Laminate		
Ankara Cherry	TL18	Priced by Size
Black	TL19	Priced by Size
Brazilian Walnut	TL20	Priced by Size
Cabinet Maple	TL21	Priced by Size
Driftwood	TL23	Priced by Size
Folkstone Grey	TL24	Priced by Size
Libretti	TL25	Priced by Size
Queenston Oak	TL26	Priced by Size
Sandalwood	TL27	Priced by Size
Walnut Amati	TL28	Priced by Size
White	TL29	Priced by Size
Grade 2 Laminate		
Classic Linen	TL17	Priced by Size
Colombian Walnut	TL55	Priced by Size
Crisp Linen	TL64	Priced by Size
Designer White	TL66	Priced by Size
Field Elm	TL13	Priced by Size
Frosty White	TL16	Priced by Size
Grey	TL62	Priced by Size
Grey Elm	TL51	Priced by Size
Kingswood Walnut	TL53	Priced by Size
Manitoba	TL56	Priced by Size
Neo Walnut	TL50	Priced by Size
Platinum	TL61	Priced by Size
Portico Teak	TL60	Priced by Size
Skyline Walnut	TL15	Priced by Size
Steel Mesh	TL59	Priced by Size
Tuscan Walnut	TL57	Priced by Size
Uptown Walnut	TL14	Priced by Size
Laminate Grade	Code	Price
Laminate Grade 1	GR1	Priced by Size
Laminate Grade 2	GR2	Priced by Size

3. Shape

Bench Top Shape	Code	Price
Rectangular Return Top	TN	Priced by Size

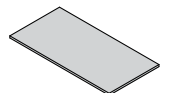

EFFECTIVE OCTOBER 17, 2022

4. Size

Returntop Size (D x W)	Code	Price	
One		Grade 1	Grade 2
24" x 36"	2436	\$196	\$294
24" x 42"	2442	\$229	\$344
24" x 48"	2448	\$261	\$392
30" x 30"	3030	\$205	\$308
30" x 36"	3036	\$244	\$366
30" x 42"	3042	\$285	\$428
Two		Grade 1	Grade 2
24" x 36"	2436	\$392	\$588
24" x 42"	2442	\$458	\$688
24" x 48"	2448	\$522	\$784
30" x 30"	3030	\$410	\$616
30" x 36"	3036	\$488	\$732
30" x 42"	3042	\$570	\$856
Three		Grade 1	Grade 2
24" x 36"	2436	\$588	\$882
24" x 42"	2442	\$687	\$1,032
24" x 48"	2448	\$783	\$1,176
30" x 30"	3030	\$615	\$924
30" x 36"	3036	\$732	\$1,098
30" x 42"	3042	\$855	\$1,284
Four		Grade 1	Grade 2
24" x 36"	2436	\$784	\$1,176
24" x 42"	2442	\$916	\$1,376
24" x 48"	2448	\$1,044	\$1,568
30" x 30"	3030	\$820	\$1,232
30" x 36"	3036	\$976	\$1,464
30" x 42"	3042	\$1,140	\$1,712
Five		Grade 1	Grade 2
24" x 36"	2436	\$980	\$1,470
24" x 42"	2442	\$1,145	\$1,720
24" x 48"	2448	\$1,305	\$1,960
30" x 30"	3030	\$1,025	\$1,540
30" x 36"	3036	\$1,220	\$1,830
30" x 42"	3042	\$1,425	\$2,140
Six		Grade 1	Grade 2
24" x 36"	2436	\$1,176	\$1,764
24" x 42"	2442	\$1,374	\$2,064
24" x 48"	2448	\$1,566	\$2,352
30" x 30"	3030	\$1,230	\$1,848
30" x 36"	3036	\$1,464	\$2,196
30" x 42"	3042	\$1,710	\$2,568

RETURN TOP

TOPS AND BASES ARE SPECIFIED AND SOLD SEPARATELY.

4. Size (Cont.)

Returntop Size (D x W)	Code	Price	
Seven		Grade 1	Grade 2
24" x 36"	2436	\$1,372	\$2,058
24" x 42"	2442	\$1,603	\$2,408
24" x 48"	2448	\$1,827	\$2,744
30" x 30"	3030	\$1,435	\$2,156
30" x 36"	3036	\$1,708	\$2,562
30" x 42"	3042	\$1,995	\$2,996
Eight		Grade 1	Grade 2
24" x 36"	2436	\$1,568	\$2,352
24" x 42"	2442	\$1,832	\$2,752
24" x 48"	2448	\$2,088	\$3,136
30" x 30"	3030	\$1,640	\$2,464
30" x 36"	3036	\$1,952	\$2,928
30" x 42"	3042	\$2,280	\$3,424

EFFECTIVE OCTOBER 17, 2022

5. Grommets

Grommet Location	Code	Price	
None	GPR00	+ \$0	
One Seat			
Left	GPR01	+ \$30	
Right	GPR03	+ \$30	
Left and Right	GPR05	+ \$60	
Two Seats			
Left	GPR01	+ \$60	
Right	GPR03	+ \$60	
Left and Right	GPR05	+ \$120	
Three Seats			
Left	GPR01	+ \$90	
Right	GPR03	+ \$90	
Left and Right	GPR05	+ \$180	
Four Seats			
Left	GPR01	+ \$120	
Right	GPR03	+ \$120	
Left and Right	GPR05	+ \$240	
Five Seats			
Left	GPR01	+ \$150	
Right	GPR03	+ \$150	
Left and Right	GPR05	+ \$300	
Six Seats			
Left	GPR01	+ \$180	
Right	GPR03	+ \$180	
Left and Right	GPR05	+ \$360	
Seven Seats			
Left	GPR01	+ \$210	
Right	GPR03	+ \$210	
Left and Right	GPR05	+ \$420	
Eight Seats			
Left	GPR01	+ \$240	
Right	GPR03	+ \$240	
Left and Right	GPR05	+ \$480	
Grommet Color	Code	Price	
Black	GC01	+ \$0	
White	GC02	+ \$0	

EFFECTIVE OCTOBER 17, 2022

1. Product

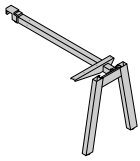
Product Type	Code	Price	
Return Base	3025	Priced by Quantity	

Orientation	Code	Price	
Single-Sided	SS	Priced by Quantity	
Back-to-Back	BB	Priced by Quantity	

Seated Postions	Code	Price	
-----------------	------	-------	--

Single-Sided

One Seat	SP1	Priced by Quantity	
Two Seats	SP2	Priced by Quantity	
Three Seats	SP3	Priced by Quantity	
Four Seats	SP4	Priced by Quantity	

Back-to-Back

Two Seats	SP2	Priced by Quantity	
Four Seats	SP4	Priced by Quantity	
Six Seats	SP6	Priced by Quantity	
Eight Seats	SP8	Priced By Quantity	

Return Quantity	Code	Price	
-----------------	------	-------	--

One	RP1	\$560	
Two	RP2	\$1,120	
Three	RP3	\$1,680	
Four	RP4	\$2,240	
Five	RP5	\$2,800	
Six	RP6	\$3,360	
Seven	RP7	\$3,920	
Eight	RP8	\$4,480	

Number of returns cannot exceed the number of seats.

RETURN BASE

TOPS AND BASES ARE SPECIFIED AND SOLD SEPARATELY.

2. Size

Returntop Size (D x W)	Code	Price	
No Return	TN0	+ \$0	
24" x 36"	TN2436	+ \$0	
24" x 42"	TN2442	+ \$0	
24" x 48"	TN2448	+ \$0	
30" x 30"	TN3030	+ \$0	
30" x 36"	TN3036	+ \$0	
30" x 42"	TN3042	+ \$0	

Return bases require the specification of a returntop size. Bases take their size from their corresponding top size.

1. Product

Product Type	Code	Price
Screen	3023	Priced By Screen Size

2. Matching Benching

Orientation	Code	Price
Single-Sided	SS	Priced By Screen Size
Back-to-Back	BB	Priced By Screen Size

Seated Positions	Code	Price
Single-Sided		

One Seat	SP1	Priced By Screen Size
Two Seats	SP2	Priced By Screen Size
Three Seats	SP3	Priced By Screen Size
Four Seats	SP4	Priced By Screen Size

Back-to-Back		
---------------------	--	--

Two Seats	SP2	Priced by Screen Size
Four Seats	SP4	Priced by Screen Size
Six Seats	SP6	Priced by Screen Size
Eight Seats	SP8	Priced by Screen Size

Bench Top Size	Code	Price
None	TZ0	Priced by Screen Size
24" x 48"	TZ2448	Priced by Screen Size
24" x 54"	TZ2454	Priced by Screen Size
24" x 60"	TZ2460	Priced by Screen Size
24" x 66"	TZ2466	Priced by Screen Size
24" x 72"	TZ2472	Priced by Screen Size
30" x 48"	TZ3048	Priced by Screen Size
30" x 54"	TZ3054	Priced by Screen Size
30" x 60"	TZ3060	Priced by Screen Size
30" x 66"	TZ3066	Priced by Screen Size
30" x 72"	TZ3072	Priced by Screen Size

Single-sided orientation comes standard with edge mounts. Back-to-back orientation includes the cost of Prize-specific screen mounts.

Screens require the specification of a bench top size. Screen length may not exceed bench top length.

3. Material

Screen Material	Code	Price
Frosted Acrylic	DT101	Priced by Screen Size
Fabric	DT701	Priced by Screen Size
Markerboard	DT301	Priced by Screen Size

4. Size

Screen Size (H x L)	Code	Price		
One Seat, Single-Sided		Acrylic	Fabric	Markerboard
12" x 48"	DS1248	\$346	\$408	\$301
12" x 54"	DS1254	\$380	\$428	\$327
12" x 60"	DS1260	\$455	\$491	\$396
12" x 66"	DS1266	\$487	\$513	\$422
12" x 72"	DS1272	\$519	\$537	\$448
18" x 48"	DS1848	\$475	\$534	\$404
18" x 54"	DS1854	\$522	\$564	\$444
18" x 60"	DS1860	\$615	\$634	\$525
18" x 66"	DS1866	\$617	\$666	\$565
18" x 72"	DS1872	\$659	\$697	\$607
24" x 48"	DS2448	\$544	\$571	\$509
24" x 54"	DS2454	\$616	\$623	\$563
24" x 60"	DS2460	\$701	\$725	\$657
24" x 66"	DS2466	\$757	\$789	\$709
24" x 72"	DS2472	\$815	\$863	\$761
Two Seat, Single-Sided		Acrylic	Fabric	Markerboard
12" x 48"	DS1248	\$692	\$816	\$602
12" x 54"	DS1254	\$760	\$856	\$654
12" x 60"	DS1260	\$910	\$982	\$792
12" x 66"	DS1266	\$974	\$1,026	\$844
12" x 72"	DS1272	\$1,038	\$1,074	\$896
18" x 48"	DS1848	\$950	\$1,068	\$808
18" x 54"	DS1854	\$1,044	\$1,128	\$888
18" x 60"	DS1860	\$1,230	\$1,268	\$1,050
18" x 66"	DS1866	\$1,234	\$1,332	\$1,130
18" x 72"	DS1872	\$1,318	\$1,394	\$1,214
24" x 48"	DS2448	\$1,088	\$1,142	\$1,018
24" x 54"	DS2454	\$1,232	\$1,246	\$1,126
24" x 60"	DS2460	\$1,402	\$1,450	\$1,314
24" x 66"	DS2466	\$1,514	\$1,578	\$1,418
24" x 72"	DS2472	\$1,630	\$1,726	\$1,522

4. Size (Cont.)

Screen Size (H x L)	Code	Price		
Three Seats, Single-Sided		Acrylic	Fabric	Markerboard
12" x 48"	DS1248	\$1,038	\$1,224	\$903
12" x 54"	DS1254	\$1,140	\$1,284	\$981
12" x 60"	DS1260	\$1,365	\$1,473	\$1,188
12" x 66"	DS1266	\$1,461	\$1,539	\$1,266
12" x 72"	DS1272	\$1,557	\$1,611	\$1,344
18" x 48"	DS1848	\$1,425	\$1,602	\$1,212
18" x 54"	DS1854	\$1,566	\$1,692	\$1,332
18" x 60"	DS1860	\$1,845	\$1,902	\$1,575
18" x 66"	DS1866	\$1,851	\$1,998	\$1,695
18" x 72"	DS1872	\$1,977	\$2,091	\$1,821
24" x 48"	DS2448	\$1,632	\$1,713	\$1,527
24" x 54"	DS2454	\$1,848	\$1,869	\$1,689
24" x 60"	DS2460	\$2,103	\$2,175	\$1,971
24" x 66"	DS2466	\$2,271	\$2,367	\$2,127
24" x 72"	DS2472	\$2,445	\$2,589	\$2,283
Four Seats, Single-Sided		Acrylic	Fabric	Markerboard
12" x 48"	DS1248	\$1,384	\$1,632	\$1,204
12" x 54"	DS1254	\$1,520	\$1,712	\$1,308
12" x 60"	DS1260	\$1,820	\$1,964	\$1,584
12" x 66"	DS1266	\$1,948	\$2,052	\$1,688
12" x 72"	DS1272	\$2,076	\$2,148	\$1,792
18" x 48"	DS1848	\$1,900	\$2,136	\$1,616
18" x 54"	DS1854	\$2,088	\$2,256	\$1,776
18" x 60"	DS1860	\$2,460	\$2,536	\$2,100
18" x 66"	DS1866	\$2,468	\$2,664	\$2,260
18" x 72"	DS1872	\$2,636	\$2,788	\$2,428
24" x 48"	DS2448	\$2,176	\$2,284	\$2,036
24" x 54"	DS2454	\$2,464	\$2,492	\$2,252
24" x 60"	DS2460	\$2,804	\$2,900	\$2,628
24" x 66"	DS2466	\$3,028	\$3,156	\$2,836
24" x 72"	DS2472	\$3,260	\$3,452	\$3,044

4. Size (Cont.)

Screen Size (H x L)	Code	Price		
Two Seats, Back-to-Back		Acrylic	Fabric	Markerboard
12" x 48"	DS1248	\$258	\$320	\$213
12" x 54"	DS1254	\$292	\$340	\$239
12" x 60"	DS1260	\$323	\$359	\$264
12" x 66"	DS1266	\$355	\$381	\$290
12" x 72"	DS1272	\$387	\$405	\$316
18" x 48"	DS1848	\$387	\$446	\$316
18" x 54"	DS1854	\$434	\$476	\$356
18" x 60"	DS1860	\$483	\$502	\$393
18" x 66"	DS1866	\$485	\$534	\$433
18" x 72"	DS1872	\$527	\$565	\$475
24" x 48"	DS2448	\$456	\$483	\$421
24" x 54"	DS2454	\$528	\$535	\$475
24" x 60"	DS2460	\$569	\$593	\$525
24" x 66"	DS2466	\$625	\$657	\$577
24" x 72"	DS2472	\$683	\$731	\$629
Four Seats, Back-to-Back		Acrylic	Fabric	Markerboard
12" x 48"	DS1248	\$516	\$640	\$426
12" x 54"	DS1254	\$584	\$680	\$478
12" x 60"	DS1260	\$646	\$718	\$528
12" x 66"	DS1266	\$710	\$762	\$580
12" x 72"	DS1272	\$774	\$810	\$632
18" x 48"	DS1848	\$774	\$892	\$632
18" x 54"	DS1854	\$868	\$952	\$712
18" x 60"	DS1860	\$966	\$1,004	\$786
18" x 66"	DS1866	\$970	\$1,068	\$866
18" x 72"	DS1872	\$1,054	\$1,130	\$950
24" x 48"	DS2448	\$912	\$966	\$842
24" x 54"	DS2454	\$1,056	\$1,070	\$950
24" x 60"	DS2460	\$1,138	\$1,186	\$1,050
24" x 66"	DS2466	\$1,250	\$1,314	\$1,154
24" x 72"	DS2472	\$1,366	\$1,462	\$1,258

EFFECTIVE OCTOBER 17, 2022

4. Size (Cont.)

Screen Size (H x L)	Code	Price		
Six Seats, Back-to-Back		Acrylic	Fabric	Markerboard
12" x 48"	DS1248	\$774	\$960	\$639
12" x 54"	DS1254	\$876	\$1,020	\$717
12" x 60"	DS1260	\$969	\$1,077	\$792
12" x 66"	DS1266	\$1,065	\$1,143	\$870
12" x 72"	DS1272	\$1,161	\$1,215	\$948
18" x 48"	DS1848	\$1,161	\$1,338	\$948
18" x 54"	DS1854	\$1,302	\$1,428	\$1,068
18" x 60"	DS1860	\$1,449	\$1,506	\$1,179
18" x 66"	DS1866	\$1,455	\$1,602	\$1,299
18" x 72"	DS1872	\$1,581	\$1,695	\$1,425
24" x 48"	DS2448	\$1,368	\$1,449	\$1,263
24" x 54"	DS2454	\$1,584	\$1,605	\$1,425
24" x 60"	DS2460	\$1,707	\$1,779	\$1,575
24" x 66"	DS2466	\$1,875	\$1,971	\$1,731
24" x 72"	DS2472	\$2,049	\$2,193	\$1,887
Eight Seats, Back-to-Back		Acrylic	Fabric	Markerboard
12" x 48"	DS1248	\$1,032	\$1,280	\$852
12" x 54"	DS1254	\$1,168	\$1,360	\$956
12" x 60"	DS1260	\$1,292	\$1,436	\$1,056
12" x 66"	DS1266	\$1,420	\$1,524	\$1,160
12" x 72"	DS1272	\$1,548	\$1,620	\$1,264
18" x 48"	DS1848	\$1,548	\$1,784	\$1,264
18" x 54"	DS1854	\$1,736	\$1,904	\$1,424
18" x 60"	DS1860	\$1,932	\$2,008	\$1,572
18" x 66"	DS1866	\$1,940	\$2,136	\$1,732
18" x 72"	DS1872	\$2,108	\$2,260	\$1,900
24" x 48"	DS2448	\$1,824	\$1,932	\$1,684
24" x 54"	DS2454	\$2,112	\$2,140	\$1,900
24" x 60"	DS2460	\$2,276	\$2,372	\$2,100
24" x 66"	DS2466	\$2,500	\$2,628	\$2,308
24" x 72"	DS2472	\$2,732	\$2,924	\$2,516

1. Power

Product Type	Code	Price
Data Pack	3029 PDP	+ \$55

Power Beam

SINGLE-SIDED | BACK-TO-BACK
INFEEED COVER | WIRE MANAGEMENT
POWER | DATA | DUPLEXES

eBEAM

POWER + DATA BEAM

Power innovation.

eBEAM is a straightforward, streamlined solution for adding power to your workstations. With adaptable legs, multiple beam lengths and cable management options that make it practically mess-free, eBEAM is simply powerful (and powerfully simple).

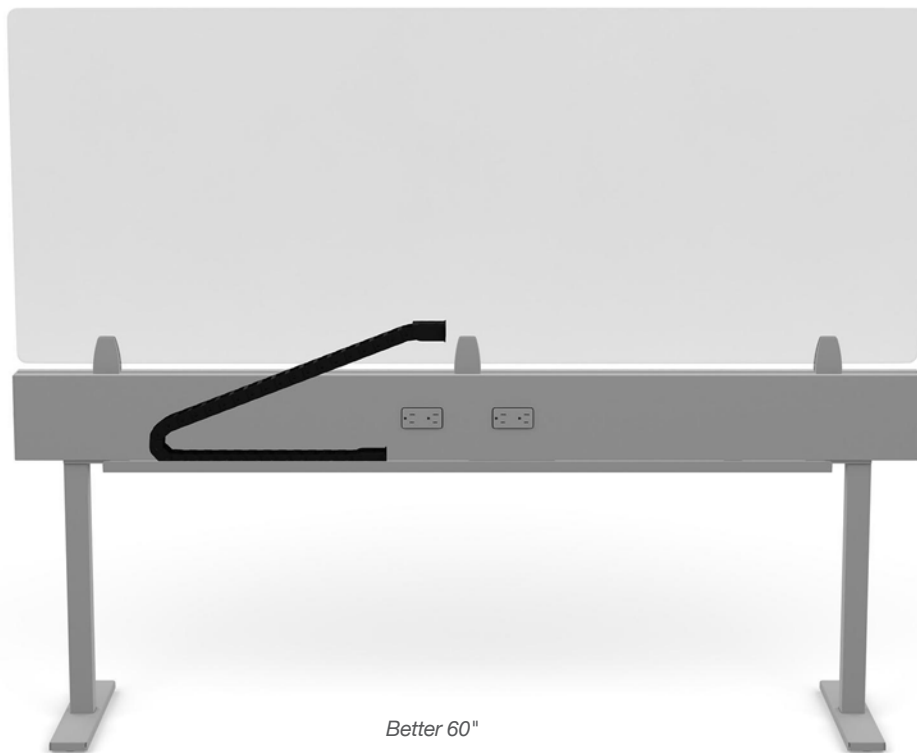

EFFECTIVE OCTOBER 17, 2022

Featured Models

60" 2-SEAT WITH NO ACCESSORIES :: \$1,225

60" beam, back to back, 2-seat, 72" conduit infeed, four duplex receptacles, no accessories

60" 2-SEAT WITH ACCESSORIES :: \$2,298

60" beam, back to back, 2-seat, 72" conduit infeed, four duplex receptacles, horizontal wire trays, vertical wire manager, 24" x 60" frosted acrylic screen

60" 4-SEAT WITH ACCESSORIES :: \$4,343

60" beam, back to back, 4-seat, 72" conduit infeed, four duplex receptacles, horizontal wire tray, vertical wire manager, infeed cover, 24" x 60" grade 1 fabric screen

Features

- Quick and easy installation in less than 10 minutes
- Cable management accessories ensure an uncluttered look
- Responsive, adaptable design includes moveable leg positions
- Fits perfectly with any static or height-adjustable tabletop
- Seamless screen integration for providing privacy
- Beam sizes: 48," 60" and 72" (W) x 24 inches (H)
- Screen height options: 12", 18", 24" and 30"
- Screen material options: Clear acrylic, frosted acrylic, fabric and whiteboard
- 10 standard configurations.
Single-sided: 1-seat, 2-seat, 3-seat, 4-seat and 5-seat.
Back-to-back: 2-seat, 4-seat, 6-seat, 8-seat and 10-seat with adjustable leg positions
- 4-circuit, 8-wire power system included with standard or optional controlled duplex receptacles
- Power system is UL183 Listed
- Toolless power installation
- Optional horizontal, vertical and infeed wire management
- Data adapter kit included
- Data modules not included. See page 134 for a list of compatible modules.
- Tabletops that are 2" undersized are available and strongly recommended for use with eBEAM

1. Product

Product Type	Code	Price
Power Beam	3242	Priced by Seated Positions



Beam Length	Code	Price
48" W Power Beam	TW48	Priced by Seated Positions
60" W Power Beam	TW60	Priced by Seated Positions
72" W Power Beam	TW72	Priced by Seated Positions

POWER BEAM

1. Product (Cont.)

Orientation	Code	Price
Single-Sided	SS	Priced by Seated Positions
Back-to-Back	BB	Priced by Seated Positions

Seated Position	Code	Price
Single-Sided		
1-Seat, 48"	SP1	\$1,105
1-Seat, 60"	SP1	\$1,148
1-Seat, 72"	SP1	\$1,189
2-Seat, 48"	SP2	\$1,855
2-Seat, 60"	SP2	\$1,932
2-Seat, 72"	SP2	\$2,008
3-Seat, 48"	SP3	\$2,708
3-Seat, 60"	SP3	\$2,822
3-Seat, 72"	SP3	\$2,938
4-Seat, 48"	SP4	\$3,560
4-Seat, 60"	SP4	\$3,713
4-Seat, 72"	SP4	\$3,866
5-Seat, 48"	SP5	\$4,413
5-Seat, 60"	SP5	\$4,605
5-Seat, 72"	SP5	\$4,796
Back-to-Back		
2-Seat, 48"	SP2	\$1,182
2-Seat, 60"	SP2	\$1,225
2-Seat, 72"	SP2	\$1,266
4-Seat, 48"	SP4	\$2,009
4-Seat, 60"	SP4	\$2,086
4-Seat, 72"	SP4	\$2,162
6-Seat, 48"	SP6	\$2,939
6-Seat, 60"	SP6	\$3,053
6-Seat, 72"	SP6	\$3,169
8-Seat, 48"	SP8	\$3,869
8-Seat, 60"	SP8	\$4,022
8-Seat, 72"	SP8	\$4,175
10-Seat, 48"	SP10	\$4,798
10-Seat, 60"	SP10	\$4,990
10-Seat, 72"	SP10	\$5,183

Beams come standard with a standard 72" power infeed.

2. Finish

Paint Color	Code	Price
Silver	BF01	+ \$0
White	BF02	+ \$0
Black	BF03	+ \$0

3. Wire Management

Wire Management Type	Code	Price
No Wire Management	WM00	+ \$0

Horizontal Wire Tray

1-Seat	WM01	+ \$105
2-Seat	WM01	+ \$210
3-Seat	WM01	+ \$315
4-Seat	WM01	+ \$420
5-Seat	WM01	+ \$525
6-Seat	WM01	+ \$630
8-Seat	WM01	+ \$840
10-Seat	WM01	+ \$1,050

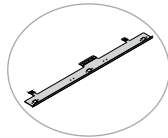

Horizontal Wire Tray And Vertical Wire Manager

1-Seat	WM06	+ \$210
2-Seat	WM06	+ \$420
3-Seat	WM06	+ \$630
4-Seat	WM06	+ \$840
5-Seat	WM06	+ \$1,050
6-Seat	WM06	+ \$1,260
8-Seat	WM06	+ \$1,680
10-Seat	WM06	+ \$2,100

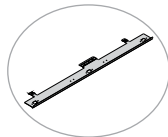

Infeed Cover	Code	Price
No Power Infeed Cover	VLC0	\$0

Power Infeed Cover	VLC1	+ \$63
--------------------	------	--------

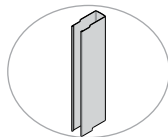

POWER BEAM

4. Electrical

Type and Length	Code	Price
Power Infeed		

No Infeed	NPIF	- \$147
72" Conduit	PIC72	+ \$0
72" Liquidtight	PIL72	+ \$12
144" Conduit	PIC144	+ \$47
144" Liquidtight	PIL144	+ \$59

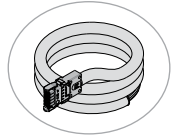

Type and Length	Code	Price
No Power, Single-Sided		

1-Seat	NPOW	- \$283
2-Seat	NPOW	- \$507
3-Seat	NPOW	- \$730
4-Seat	NPOW	- \$954
5-Seat	NPOW	- \$1,177

No Power, Back-to-Back

2-Seat	NPOW	- \$283
4-Seat	NPOW	- \$507
6-Seat	NPOW	- \$730
8-Seat	NPOW	- \$954
10-Seat	NPOW	- \$1,177

Duplexes	Code	Price
----------	------	-------

Standard Duplex Receptacles, Two Per Seat	SDUP	+ \$0
---	------	-------

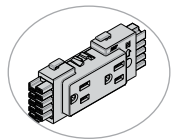

No Duplexes

1-Seat	NDUP	- \$79
2-Seat	NDUP	- \$158
3-Seat	NDUP	- \$237
4-Seat	NDUP	- \$316
5-Seat	NDUP	- \$395
6-Seat	NDUP	- \$474
8-Seat	NDUP	- \$632
10-Seat	NDUP	- \$790

Duplex receptacle color will match beam color. When power is specified in beam, it includes duplexes for circuits 1, 2, 3, and 4. For other combinations of duplexes and controlled duplexes, specify "no duplexes" and order as standalone components.

1. Product

Product Type	Code	Price
Screen for EBEAM	3243	Priced by Size
Beam	Code	Price
48"	TW48	Priced by Size
60"	TW60	Priced by Size
72"	TW72	Priced by Size
Beam Orientation	Code	Price
Single-Sided	SS	Priced by Size
Back-to-Back	BB	Priced by Size
Seated Positions	Code	Price
Single-Sided		
1-Seat	SP1	Priced by Size
2-Seat	SP2	Priced by Size
3-Seat	SP3	Priced by Size
4-Seat	SP4	Priced by Size
5-Seat	SP5	Priced by Size
Back-to-Back		
2-Seat	SP2	Priced by Size
4-Seat	SP4	Priced by Size
6-Seat	SP6	Priced by Size
8-Seat	SP8	Priced by Size
10-Seat	SP10	Priced by Size

2. Material

Material Type	Code	Price
Motif Fabric	DT701	Priced by Size
Sector Frosted Acrylic	DT101	Priced by Size
Sector Clear Acrylic	DT101C	Priced by Size
Doodle Markerboard	DT301	Priced by Size
Grade	Code	Price
Fabric/Vinyl Grade 1	FG1/VG1	Priced by Size
Fabric/Vinyl Grade 2	FG2/VG2	Priced by Size
Fabric/Vinyl Grade 3	FG3/VG3	Priced by Size
Fabric/Vinyl Grade 4	FG4/VG4	Priced by Size
Fabric/Vinyl Grade 5	FG5/VG5	Priced by Size

The following prices are for grade 1 fabrics/vinyls only. For higher grade pricing, add the appropriate upcharge from the Motif price list.

POWER BEAM SCREENS

3. Size

Screen Size (H x L)	Code	Grade 1 Price		
1-Seat, Single-Sided		Acrylic	Fabric	Markerboard
12" x 48"	DS1248	\$314	\$376	\$269
18" x 48"	DS1848	\$443	\$502	\$372
24" x 48"	DS2448	\$512	\$539	\$477
30" x 48"	DS3048	N/A	\$666	\$565
12" x 60"	DS1260	\$407	\$443	\$348
18" x 60"	DS1860	\$567	\$586	\$477
24" x 60"	DS2460	\$653	\$677	\$609
30" x 60"	DS3060	N/A	\$801	\$719
12" x 72"	DS1272	\$471	\$489	\$400
18" x 72"	DS1872	\$611	\$649	\$559
24" x 72"	DS2472	\$767	\$815	\$713
30" x 72"	DS3072	N/A	\$841	\$845
2-Seat, Single-Sided		Acrylic	Fabric	Markerboard
12" x 48"	DS1248	\$628	\$752	\$538
18" x 48"	DS1848	\$886	\$1,004	\$744
24" x 48"	DS2448	\$1,024	\$1,078	\$954
30" x 48"	DS3048	N/A	\$1,332	\$1,130
12" x 60"	DS1260	\$814	\$886	\$696
18" x 60"	DS1860	\$1,134	\$1,172	\$954
24" x 60"	DS2460	\$1,306	\$1,354	\$1,218
30" x 60"	DS3060	N/A	\$1,602	\$1,438
12" x 72"	DS1272	\$942	\$978	\$800
18" x 72"	DS1872	\$1,222	\$1,298	\$1,118
24" x 72"	DS2472	\$1,534	\$1,630	\$1,426
30" x 72"	DS3072	N/A	\$1,682	\$1,690
3-Seat, Single-Sided		Acrylic	Fabric	Markerboard
12" x 48"	DS1248	\$942	\$1,128	\$807
18" x 48"	DS1848	\$1,329	\$1,506	\$1,116
24" x 48"	DS2448	\$1,536	\$1,617	\$1,431
30" x 48"	DS3048	N/A	\$1,998	\$1,695
12" x 60"	DS1260	\$1,221	\$1,329	\$1,044
18" x 60"	DS1860	\$1,701	\$1,758	\$1,431
24" x 60"	DS2460	\$1,959	\$2,031	\$1,827
30" x 60"	DS3060	N/A	\$2,403	\$2,157
12" x 72"	DS1272	\$1,413	\$1,467	\$1,200
18" x 72"	DS1872	\$1,833	\$1,947	\$1,677
24" x 72"	DS2472	\$2,301	\$2,445	\$2,139
30" x 72"	DS3072	N/A	\$2,523	\$2,535

4. Size (Cont.)

Screen Size (H x L)	Code	Grade 1 Price		
4-Seat, Single-Sided		Acrylic	Fabric	Markerboard
12" x 48"	DS1248	\$1,256	\$1,504	\$1,076
18" x 48"	DS1848	\$1,772	\$2,008	\$1,488
24" x 48"	DS2448	\$2,048	\$2,156	\$1,908
30" x 48"	DS3048	N/A	\$2,664	\$2,260
12" x 60"	DS1260	\$1,628	\$1,772	\$1,392
18" x 60"	DS1860	\$2,268	\$2,344	\$1,908
24" x 60"	DS2460	\$2,612	\$2,708	\$2,436
30" x 60"	DS3060	N/A	\$3,204	\$2,876
12" x 72"	DS1272	\$1,884	\$1,956	\$1,600
18" x 72"	DS1872	\$2,444	\$2,596	\$2,236
24" x 72"	DS2472	\$3,068	\$3,260	\$2,852
30" x 72"	DS3072	N/A	\$3,364	\$3,380
5-Seat, Single-Sided		Acrylic	Fabric	Markerboard
12" x 48"	DS1248	\$1,570	\$1,880	\$1,345
18" x 48"	DS1848	\$2,215	\$2,510	\$1,860
24" x 48"	DS2448	\$2,560	\$2,695	\$2,385
30" x 48"	DS3048	N/A	\$3,330	\$2,825
12" x 60"	DS1260	\$2,035	\$2,215	\$1,740
18" x 60"	DS1860	\$2,835	\$2,930	\$2,385
24" x 60"	DS2460	\$3,265	\$3,385	\$3,045
30" x 60"	DS3060	N/A	\$4,005	\$3,595
12" x 72"	DS1272	\$2,355	\$2,445	\$2,000
18" x 72"	DS1872	\$3,055	\$3,245	\$2,795
24" x 72"	DS2472	\$3,835	\$4,075	\$3,565
30" x 72"	DS3072	N/A	\$4,205	\$4,225
2-Seat, Back-to-Back		Acrylic	Fabric	Markerboard
12" x 48"	DS1248	\$314	\$376	\$269
18" x 48"	DS1848	\$443	\$502	\$372
24" x 48"	DS2448	\$512	\$539	\$477
30" x 48"	DS3048	N/A	\$666	\$565
12" x 60"	DS1260	\$407	\$443	\$348
18" x 60"	DS1860	\$567	\$586	\$477
24" x 60"	DS2460	\$653	\$677	\$609
30" x 60"	DS3060	N/A	\$801	\$719
12" x 72"	DS1272	\$471	\$489	\$400
18" x 72"	DS1872	\$611	\$649	\$559
24" x 72"	DS2472	\$767	\$815	\$713
30" x 72"	DS3072	N/A	\$841	\$845

4. Size (Cont.)

Screen Size (H x L)	Code	Grade 1 Price		
4-Seat, Back-to-Back		Acrylic	Fabric	Markerboard
12" x 48"	DS1248	\$628	\$752	\$538
18" x 48"	DS1848	\$886	\$1,004	\$744
24" x 48"	DS2448	\$1,024	\$1,078	\$954
30" x 48"	DS3048	N/A	\$1,332	\$1,130
12" x 60"	DS1260	\$814	\$886	\$696
18" x 60"	DS1860	\$1,134	\$1,172	\$954
24" x 60"	DS2460	\$1,306	\$1,354	\$1,218
30" x 60"	DS3060	N/A	\$1,602	\$1,438
12" x 72"	DS1272	\$942	\$978	\$800
18" x 72"	DS1872	\$1,222	\$1,298	\$1,118
24" x 72"	DS2472	\$1,534	\$1,630	\$1,426
30" x 72"	DS3072	N/A	\$1,682	\$1,690
6-Seat, Back-to-Back		Acrylic	Fabric	Markerboard
12" x 48"	DS1248	\$942	\$1,128	\$807
18" x 48"	DS1848	\$1,329	\$1,506	\$1,116
24" x 48"	DS2448	\$1,536	\$1,617	\$1,431
30" x 48"	DS3048	N/A	\$1,998	\$1,695
12" x 60"	DS1260	\$1,221	\$1,329	\$1,044
18" x 60"	DS1860	\$1,701	\$1,758	\$1,431
24" x 60"	DS2460	\$1,959	\$2,031	\$1,827
30" x 60"	DS3060	N/A	\$2,403	\$2,157
12" x 72"	DS1272	\$1,413	\$1,467	\$1,200
18" x 72"	DS1872	\$1,833	\$1,947	\$1,677
24" x 72"	DS2472	\$2,301	\$2,445	\$2,139
30" x 72"	DS3072	N/A	\$2,523	\$2,535
8-Seat, Back-to-Back		Acrylic	Fabric	Markerboard
12" x 48"	DS1248	\$1,256	\$1,504	\$1,076
18" x 48"	DS1848	\$1,772	\$2,008	\$1,488
24" x 48"	DS2448	\$2,048	\$2,156	\$1,908
30" x 48"	DS3048	N/A	\$2,664	\$2,260
12" x 60"	DS1260	\$1,628	\$1,772	\$1,392
18" x 60"	DS1860	\$2,268	\$2,344	\$1,908
24" x 60"	DS2460	\$2,612	\$2,708	\$2,436
30" x 60"	DS3060	N/A	\$3,204	\$2,876
12" x 72"	DS1272	\$1,884	\$1,956	\$1,600
18" x 72"	DS1872	\$2,444	\$2,596	\$2,236
24" x 72"	DS2472	\$3,068	\$3,260	\$2,852
30" x 72"	DS3072	N/A	\$3,364	\$3,380

EFFECTIVE OCTOBER 17, 2022

4. Size (Cont.)

Screen Size (H x L)	Code	Grade 1 Price		
		Acrylic	Fabric	Markerboard
10-Seat, Back-to-Back				
12" x 48"	DS1248	\$1,570	\$1,880	\$1,345
18" x 48"	DS1848	\$2,215	\$2,510	\$1,860
24" x 48"	DS2448	\$2,560	\$2,695	\$2,385
30" x 48"	DS3048	N/A	\$3,330	\$2,825
12" x 60"	DS1260	\$2,035	\$2,215	\$1,740
18" x 60"	DS1860	\$2,835	\$2,930	\$2,385
24" x 60"	DS2460	\$3,265	\$3,385	\$3,045
30" x 60"	DS3060	N/A	\$4,005	\$3,595
12" x 72"	DS1272	\$2,355	\$2,445	\$2,000
18" x 72"	DS1872	\$3,055	\$3,245	\$2,795
24" x 72"	DS2472	\$3,835	\$4,075	\$3,565
30" x 72"	DS3072	N/A	\$4,205	\$4,225

SPECIFICATIONS

	3242 TW42 42" Beam	3242 TW60 60" Beam	3242 TW72 72" Beam
Dimensions			
Beam Length (With End Cap)	48.75"	60.75"	72.75"
Beam Height	5.8"	5.8"	5.8"
Beam Width	2.5"	2.5"	2.5"
Overall Height	24.1"	24.1"	24.1"
Height From Floor to Beam	18.3"	18.3"	18.3"
Leg Width	2.5"	2.5"	2.5"
Foot Width	1.6"	1.6"	1.6"
Foot Length	14.5"	14.5"	14.5"
Length From End to Duplex	19.7"	25.7"	31.7"

5. Clamp Color

Paint Color	Code	Price
Silver	BF01	+ \$0
White	BF02	+ \$0
Black	BF03	+ \$0

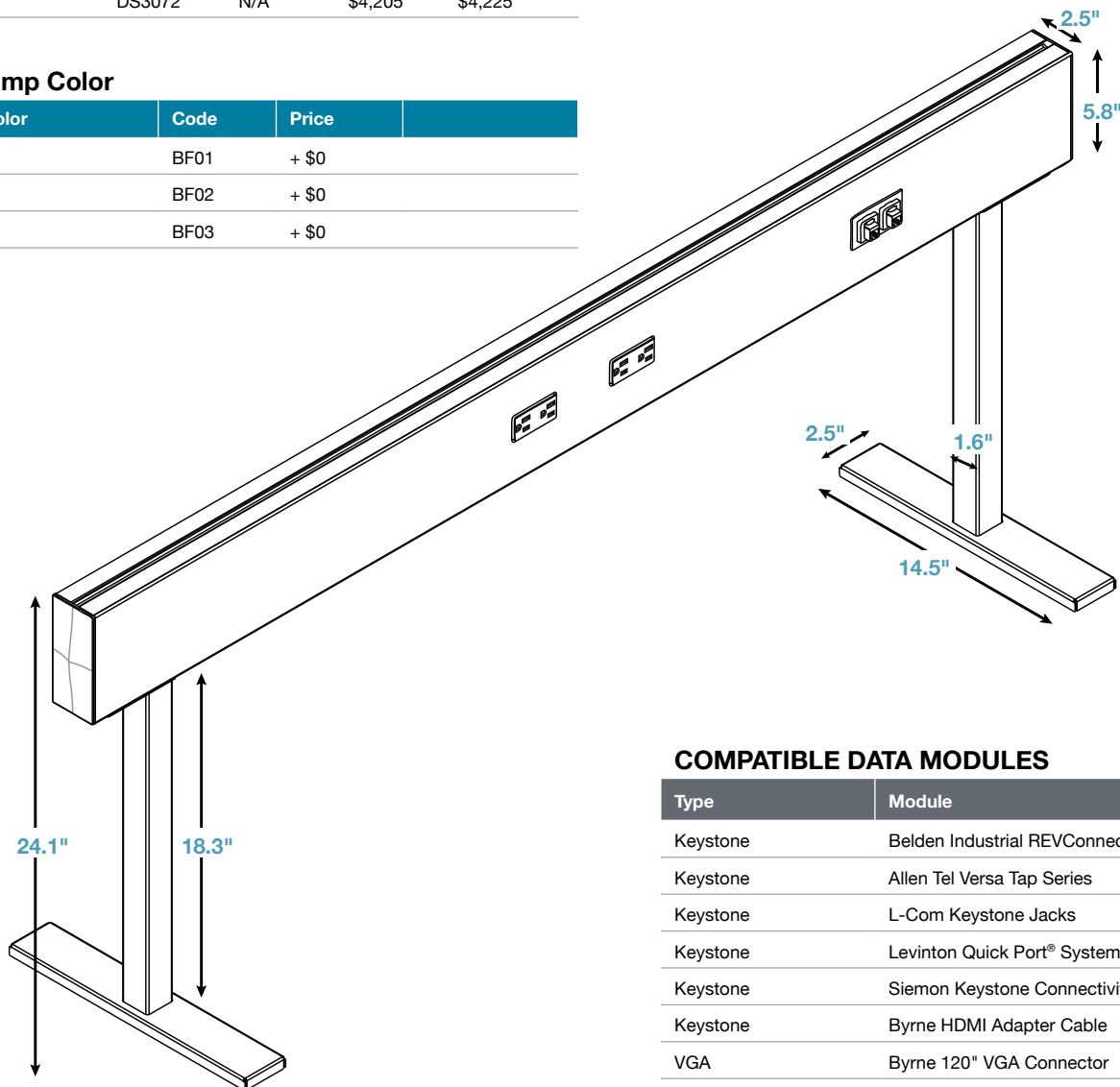

COMPATIBLE DATA MODULES

Type	Module
Keystone	Belden Industrial REVConnect
Keystone	Allen Tel Versa Tap Series
Keystone	L-Com Keystone Jacks
Keystone	Levinton Quick Port® System Adapters and Jacks
Keystone	Siemon Keystone Connectivity Solutions
Keystone	Byrne HDMI Adapter Cable
VGA	Byrne 120" VGA Connector

EFFECTIVE OCTOBER 17, 2022

1. Product

Category	Code	Price
Stand-Alone Components for Power Beams	3249	Priced by Type
Type	Code	Price
Electrical		

Duplex Receptacle	ATC04	\$40	
-------------------	-------	------	---

Wire Management

Horizontal Wire Tray	ATC01 WM01	+ \$105	
----------------------	---------------	---------	---

Horizontal Wire Tray and Vertical Wire Manager	ATC01 WM06	+ \$210	
--	---------------	---------	--

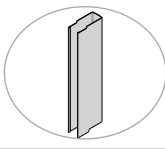
Power Infeed Cover	ATC02 VLC1	+ \$63	
--------------------	---------------	--------	---

2. Circuit (For Duplexes Only)

Circuit Number	Code	Price
Circuit 1	DC1	+ \$0
Circuit 2	DC2	+ \$0
Circuit 3	DC3	+ \$0
Circuit 4	DC4	+ \$0

Title 24 (Controlled)

Circuit 1	DC1C	+ \$7
Circuit 2	DC2C	+ \$7
Circuit 3	DC3C	+ \$7
Circuit 4	DC4C	+ \$7

3. Color

Wire Management Color	Code	Price
Silver	BF01	+ \$0
White	BF02	+ \$0
Black	BF03	+ \$0

Vertical wire managers are only available in black. Color will apply to the horizontal wire tray only.

Appendix

HELPFUL REFERENCE MATERIAL

STAND-ALONE TABLETOPS

GSA SIN #: 33721

1. Table or Desk Top

Product Type	Code	Price
Tabletop or Desktop	3000	Priced by Size

2. Finish

Laminate	Code	Price
Grade 1 Laminate		
Ankara Cherry	TL18	Priced by Size
Black	TL19	Priced by Size
Brazilian Walnut	TL20	Priced by Size
Cabinet Maple	TL21	Priced by Size
Driftwood	TL23	Priced by Size
Folkstone Grey	TL24	Priced by Size
Libretti	TL25	Priced by Size
Queenston Oak	TL26	Priced by Size
Sandalwood	TL27	Priced by Size
Walnut Amati	TL28	Priced by Size
White	TL29	Priced by Size
Grade 2 Laminate		
Classic Linen	TL17	Priced by Size
Colombian Walnut	TL55	Priced by Size
Crisp Linen	TL64	Priced by Size
Designer White	TL66	Priced by Size
Field Elm	TL13	Priced by Size
Frosty White	TL16	Priced by Size
Grey	TL62	Priced by Size
Grey Elm	TL51	Priced by Size
Kingswood Walnut	TL53	Priced by Size
Manitoba	TL56	Priced by Size
Neo Walnut	TL50	Priced by Size
Platinum	TL61	Priced by Size
Portico Teak	TL60	Priced by Size
Skyline Walnut	TL15	Priced by Size
Steel Mesh	TL59	Priced by Size
Tuscan Walnut	TL57	Priced by Size
Uptown Walnut	TL14	Priced by Size
Laminate Grade	Code	Price
Laminate Grade 1	GR1	Priced by Size
Laminate Grade 2	GR2	Priced by Size

3. Shape

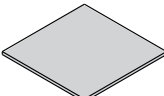
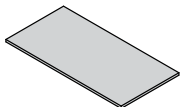
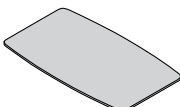
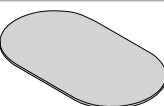
Tabletop Shape	Code	Price	
Café and Occasional			
Round	TR	Priced by Size	
Square	TS	Priced by Size	
Multipurpose and Training			
Rectangular	TZ	Priced by Size	
Meeting			
Wide Boat	TB	Priced by Size	
Wide Racetrack	TK	Priced by Size	

STAND-ALONE TABLETOPS

GSA SIN #: 33721

3. Shape (Cont.)

Tabletop Shape	Code	Price	
For 3-Leg Bases			
Right 90-Degree Tabletop	TBCR	Priced by Size	
Left 90-Degree Tabletop	TBCL	Priced by Size	
120-Degree Top	TA	Priced by Size	
Right Extended Corner	TXR	Priced by Size	
Left Extended Corner	TXL	Priced by Size	
Right Extended Offset Corner	OR	Priced by Size	
Left Extended Offset Corner	OL	Priced by Size	

4. Size

Top Size	Code	Price		
Round (D x W)		Grade 1	Grade 2 Flat Edge	Grade 2 Knife Edge
24"	2424	\$287	\$431	\$494
30"	3030	\$331	\$497	\$536
36"	3636	\$383	\$575	\$622
42"	4242	\$385	\$578	\$694
48"	4848	\$458	\$687	\$825
54"	5454	\$800	\$1,200	\$1,440
60"	6060	\$1,200	\$1,800	\$2,160

Actual size of 30" x 30" tabletop is 30.75" x 30.75"

4. Size (Cont.)

Top Size	Code	Price		
Square (D x W)		Grade 1	Grade 2 Flat Edge	Grade 2 Knife Edge
24"	2424	\$274	\$411	\$494
30"	3030	\$297	\$446	\$536
36"	3636	\$345	\$518	\$622
42"	4242	\$385	\$578	\$694
48"	4848	\$458	\$687	\$825
54"	5454	\$800	\$1,200	\$1,440
60"	6060	\$1,200	\$1,800	\$2,160
Standard Rectangular (D x W)		Grade 1	Grade 2 Flat Edge	Grade 2 Knife Edge
18" x 42"	1842	\$176	\$264	\$317
18" x 48"	1848	\$200	\$300	\$360
18" x 54"	1854	\$225	\$338	\$406
18" x 60"	1860	\$248	\$372	\$447
18" x 66"	1866	\$275	\$413	\$496
18" x 72"	1872	\$300	\$450	\$540
20" x 36"	2036	\$164	\$246	
20" x 42"	2042	\$190	\$285	
20" x 48"	2048	\$218	\$327	
20" x 54"	2054	\$255	\$383	
20" x 60"	2060	\$270	\$405	
20" x 66"	2066	\$299	\$449	
20" x 72"	2072	\$324	\$486	
24" x 36"	2436	\$196	\$294	
24" x 42"	2442	\$229	\$344	\$413
24" x 48"	2448	\$261	\$392	\$471
24" x 54"	2454	\$292	\$438	\$526
24" x 60"	2460	\$324	\$486	\$584
24" x 66"	2466	\$358	\$537	\$645
24" x 72"	2472	\$389	\$584	\$701
24" x 78"	2478	\$421	\$632	
24" x 84"	2484	\$453	\$680	
30" x 36"	3036	\$244	\$366	
30" x 42"	3042	\$285	\$428	\$514
30" x 48"	3048	\$324	\$486	\$584
30" x 54"	3054	\$366	\$549	\$659
30" x 60"	3060	\$404	\$606	\$694
30" x 66"	3066	\$445	\$668	\$802
30" x 72"	3072	\$484	\$726	\$810
30" x 78"	3078	\$526	\$789	
30" x 84"	3084	\$565	\$848	

STAND-ALONE TABLETOPS

4. Size (Cont.)

Top Size	Code	Price		
Standard Rectangular (D x W)		Grade 1	Grade 2 Flat Edge	Grade 2 Knife Edge
36" x 42"	3642	\$540	\$810	\$972
36" x 48"	3648	\$570	\$855	\$1,026
36" x 54"	3654	\$625	\$938	\$1,126
36" x 60"	3660	\$700	\$1,050	\$1,260
36" x 66"	3666	\$790	\$1,185	\$1,422
36" x 72"	3672	\$800	\$1,200	\$1,440
42" x 78"	4278	\$821	\$1,232	
42" x 84"	4284	\$885	\$1,328	
42" x 90"	4290	\$964	\$1,446	
42" x 96"	4296	\$1,008	\$1,512	
48" x 78"	4878	\$939	\$1,409	
48" x 84"	4884	\$1,008	\$1,512	
48" x 90"	4890	\$1,108	\$1,662	
48" x 96"	4896	\$1,152	\$1,728	
Rectangular for Use with eBEAM (D x W)		Grade 1	Grade 2 Flat Edge	Grade 2 Knife Edge
24" x 46"	2446	\$261	\$392	
24" x 58"	2458	\$324	\$486	
24" x 70"	2470	\$389	\$584	
30" x 46"	3046	\$324	\$486	
30" x 58"	3058	\$404	\$606	
30" x 70"	3070	\$484	\$726	
Wide Boat (D x W)		Grade 1	Grade 2 Flat Edge	Grade 2 Knife Edge
42" x 78"	4278	\$821	\$1,232	
42" x 84"	4284	\$885	\$1,328	
42" x 90"	4290	\$964	\$1,446	
42" x 96"	4296	\$1,008	\$1,512	
48" x 78"	4878	\$939	\$1,409	
48" x 84"	4884	\$1,008	\$1,512	
48" x 90"	4890	\$1,108	\$1,662	
48" x 96"	4896	\$1,152	\$1,728	

4. Size (Cont.)

Top Size	Code	Price		
Racetrack (D x W)		Grade 1	Grade 2 Flat Edge	Grade 2 Knife Edge
24" x 60"	2460	\$324	\$486	\$584
30" x 72"	3072	\$450	\$675	\$810
30" x 84"	3084	\$565	\$848	\$1,018
30" x 96"	3096	\$850	\$1,275	\$1,530
36" x 72"	3672	\$800	\$1,200	\$1,440
36" x 84"	3684	\$875	\$1,313	\$1,576
36" x 96"	3696	\$950	\$1,425	\$1,710
42" x 78"	4278	\$821	\$1,232	
42" x 84"	4284	\$885	\$1,328	
42" x 90"	4290	\$964	\$1,446	
42" x 96"	4296	\$1,008	\$1,512	
48" x 78"	4878	\$939	\$1,409	
48" x 84"	4884	\$1,008	\$1,512	
48" x 90"	4890	\$1,108	\$1,662	
48" x 96"	4896	\$1,152	\$1,728	
Right 90-Degree Top (D x W)		Grade 1	Grade 2 Flat Edge	Grade 2 Knife Edge
24" x 48"	2448	\$517	\$776	
24" x 54"	2454	\$582	\$873	
24" x 60"	2460	\$645	\$968	
30" x 48"	3048	\$645	\$968	
30" x 54"	3054	\$729	\$1,094	
30" x 60"	3060	\$805	\$1,208	
Left 90-Degree Top (D x W)		Grade 1	Grade 2 Flat Edge	Grade 2 Knife Edge
24" x 48"	2448	\$517	\$776	
24" x 54"	2454	\$582	\$873	
24" x 60"	2460	\$645	\$968	
30" x 48"	3048	\$645	\$968	
30" x 54"	3054	\$729	\$1,094	
30" x 60"	3060	\$805	\$1,208	
120-Degree Top (D x W)		Grade 1	Grade 2 Flat Edge	Grade 2 Knife Edge
24" x 42"	2442	\$705	\$1,058	
24" x 48"	2448	\$908	\$1,362	
30" x 42"	3042	\$736	\$1,104	
30" x 48"	3048	\$917	\$1,376	

STAND-ALONE TABLETOPS

4. Size (Cont.)

Top Size	Code	Price		
Right Extended Corner (A x B x C)		Grade 1	Grade 2 Flat Edge	Grade 2 Knife Edge
24" x 36" x 60"	243660	\$485	\$728	
24" x 36" x 66"	243666	\$547	\$821	
24" x 36" x 72"	243672	\$618	\$927	
24" x 42" x 60"	244260	\$557	\$836	
24" x 42" x 66"	244266	\$629	\$944	
24" x 42" x 72"	244272	\$710	\$1,065	
24" x 48" x 60"	244860	\$613	\$920	
24" x 48" x 66"	244866	\$692	\$1,038	
24" x 48" x 72"	244872	\$781	\$1,172	
30" x 36" x 60"	303660	\$557	\$836	
30" x 36" x 66"	303666	\$629	\$944	
30" x 36" x 72"	303672	\$760	\$1,140	
30" x 42" x 60"	304260	\$640	\$960	
30" x 42" x 66"	304266	\$723	\$1,085	
30" x 42" x 72"	304272	\$817	\$1,226	
30" x 48" x 60"	304860	\$672	\$1,008	
30" x 48" x 66"	304866	\$760	\$1,140	
30" x 48" x 72"	304872	\$860	\$1,290	
Left Extended Corner (A x B x C)		Grade 1	Grade 2	
24" x 60" x 36"	246036	\$485	\$728	
24" x 66" x 36"	246636	\$547	\$821	
24" x 72" x 36"	247236	\$618	\$927	
24" x 60" x 42"	246042	\$557	\$836	
24" x 66" x 42"	246642	\$629	\$944	
24" x 72" x 42"	247242	\$710	\$1,065	
24" x 60" x 48"	246048	\$613	\$920	
24" x 66" x 48"	246648	\$692	\$1,038	
24" x 72" x 48"	247248	\$781	\$1,172	
30" x 60" x 36"	306036	\$557	\$836	
30" x 66" x 36"	306636	\$629	\$944	
30" x 72" x 36"	307236	\$760	\$1,140	
30" x 60" x 42"	306042	\$640	\$960	
30" x 66" x 42"	306642	\$723	\$1,085	
30" x 72" x 42"	307242	\$817	\$1,226	
30" x 60" x 48"	306048	\$672	\$1,008	
30" x 66" x 48"	306648	\$760	\$1,140	
30" x 72" x 48"	307248	\$860	\$1,290	

4. Size (Cont.)

Top Size	Code	Price		
Right Extended Offset Corner (A x B x C x D)		Grade 1	Grade 2	
24" x 36" x 60" x 30"	24366030	\$531	\$797	
24" x 36" x 66" x 30"	24366630	\$604	\$906	
24" x 36" x 72" x 30"	24367230	\$685	\$1,028	
24" x 42" x 60" x 30"	24426030	\$616	\$924	
24" x 42" x 66" x 30"	24426630	\$697	\$1,046	
24" x 42" x 72" x 30"	24427230	\$793	\$1,190	
24" x 48" x 60" x 30"	24486030	\$648	\$972	
24" x 48" x 66" x 30"	24486630	\$735	\$1,103	
24" x 48" x 72" x 30"	24487230	\$835	\$1,253	
Left Extended Offset Corner (A x B x C x D)		Grade 1	Grade 2	
30" x 60" x 36" x 24"	30603624	\$531	\$797	
30" x 66" x 36" x 24"	30663624	\$604	\$906	
30" x 72" x 36" x 24"	30723624	\$685	\$1,028	
30" x 60" x 42" x 24"	30604224	\$616	\$924	
30" x 66" x 42" x 24"	30664224	\$697	\$1,046	
30" x 72" x 42" x 24"	30724224	\$793	\$1,190	
30" x 60" x 48" x 24"	30604824	\$648	\$972	
30" x 66" x 48" x 24"	30664824	\$735	\$1,103	
30" x 72" x 48" x 24"	30724824	\$835	\$1,253	

5. Grommets

Grommet Location	Code	Price	
No Grommets	GP00	+ \$0	
Left Only	GP01	+ \$30	
Center Only	GP02	+ \$30	
Right Only	GP03	+ \$30	
Left and Center	GP04	+ \$60	
Left and Right	GP05	+ \$60	
Right and Center	GP06	+ \$60	
Left, Right and Center	GP07	+ \$90	
Grommet Color	Code	Price	
Black	GC01	+ \$0	
White	GC02	+ \$0	

Left grommets (GP01/GP04/GP05/GP07) are not available on right extended corners or right extended offset corners.

Right grommets (GP03/GP05/GP06/GP07) are not available on left extended corners or right extended offset corners.

STAND-ALONE TABLETOPS

5. Add-Ons

Mending Plate	Code	Price
None	TTMP0	+ \$0

Mending Plate Kit	TTMP1	+ \$74
-------------------	-------	--------

Stiffener	Code	Price
No Stiffener	STF00	+ \$0
54" Stiffener (1 Each)	STF01	+ \$80
54" Stiffeners (2 Each)	STF02	+ \$160

Mending plate kits are available with tabletops that have a depth of 20", 24" or 30".

Stiffeners are available with and recommended for tabletops that have a depth of 42" or more and/or a width of 66" or more.

Table Weights

Top Size	Grade 1 Laminate	Grade 2 Laminate
Round (D x W)		
24" x 24"	14 lb	15 lb
30" x 30"	21 lb	23 lb
36" x 36"	31 lb	34 lb
42" x 42"	42 lb	46 lb
48" x 48"	54 lb	60 lb
Square (D x W)		
24" x 24"	17 lb	19 lb
30" x 30"	27 lb	30 lb
36" x 36"	39 lb	43 lb
42" x 42"	53 lb	58 lb
48" x 48"	69 lb	76 lb
Wide Boat (D x W)		
42" x 78"	89 lb	96 lb
42" x 84"	96 lb	104 lb
42" x 90"	103 lb	112 lb
42" x 96"	109 lb	121 lb
48" x 78"	103 lb	107 lb
48" x 84"	111 lb	117 lb
48" x 90"	119 lb	126 lb
48" x 96"	127 lb	136 lb

Table Weights (Cont.)

Top Size	Grade 1 Laminate	Grade 2 Laminate
Wide Racetrack (D x W)		
42" x 78"	87 lb	98 lb
42" x 84"	94 lb	105 lb
42" x 90"	102 lb	113 lb
42" x 96"	110 lb	120 lb
48" x 78"	97 lb	113 lb
48" x 84"	106 lb	122 lb
48" x 90"	115 lb	131 lb
48" x 96"	123 lb	139 lb
Rectangular for Use with eBEAM (-2") (D x W)		
24" x 46"	33 lb	36 lb
24" x 58"	42 lb	46 lb
24" x 70"	50 lb	55 lb
30" x 46"	41 lb	46 lb
30" x 58"	52 lb	57 lb
30" x 70"		

Actual size of 30" x 30" tabletop is 30.75" x 30.75"

STAND-ALONE TABLETOPS

Table Weights (Cont.)

Top Size	Grade 1 Laminate	Grade 2 Laminate
Standard Rectangular (D x W)		
18" x 42"	23 lb	25 lb
18" x 48"	26 lb	29 lb
18" x 54"	29 lb	32 lb
18" x 60"	32 lb	36 lb
18" x 66"	36 lb	39 lb
18" x 72"	39 lb	43 lb
20" x 36"	22 lb	24 lb
20" x 42"	25 lb	28 lb
20" x 48"	29 lb	32 lb
20" x 54"	32 lb	36 lb
20" x 60"	36 lb	40 lb
20" x 66"	40 lb	44 lb
20" x 72"	43 lb	48 lb
24" x 36"	26 lb	29 lb
24" x 42"	30 lb	33 lb
24" x 48"	35 lb	38 lb
24" x 54"	39 lb	43 lb
24" x 60"	43 lb	48 lb
24" x 66"	48 lb	52 lb
24" x 72"	52 lb	57 lb
24" x 78"	56 lb	62 lb
24" x 84"	60 lb	67 lb
30" x 36"	32 lb	36 lb
30" x 42"	38 lb	42 lb
30" x 48"	43 lb	48 lb
30" x 54"	49 lb	53 lb
30" x 60"	54 lb	59 lb
30" x 66"	59 lb	65 lb
30" x 72"	65 lb	71 lb
30" x 78"	70 lb	77 lb
30" x 84"	76 lb	83 lb
42" x 78"	98 lb	108 lb
42" x 84"	106 lb	116 lb
42" x 90"	113 lb	125 lb
42" x 96"	121 lb	133 lb
48" x 78"	112 lb	124 lb
48" x 84"	121 lb	133 lb
48" x 90"	130 lb	143 lb
48" x 96"	138 lb	152 lb

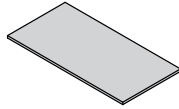
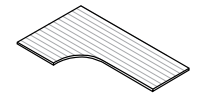
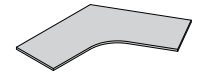
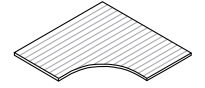
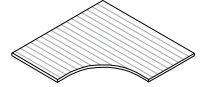

Table Weights (Cont.)

Top Size	Grade 1 Laminate	Grade 2 Laminate
Right 90-Degree Top (D x W)		
24" x 48"	54 lb	59 lb
24" x 54"	63 lb	69 lb
24" x 60"	71 lb	78 lb
30" x 48"	61 lb	68 lb
30" x 54"	72 lb	79 lb
30" x 60"	83 lb	91 lb
Left 90-Degree Top (D x W)		
24" x 48"	54 lb	59 lb
24" x 54"	63 lb	69 lb
24" x 60"	71 lb	78 lb
30" x 48"	61 lb	68 lb
30" x 54"	72 lb	79 lb
30" x 60"	83 lb	91 lb
120-Degree Top (D x W)		
24" x 42"	51 lb	56 lb
24" x 48"	60 lb	66 lb
30" x 42"	61 lb	67 lb
30" x 48"	71 lb	78 lb
Right Extended Corner (A x B x C)		
24" x 36" x 60"	52 lb	58 lb
24" x 36" x 66"	57 lb	62 lb
24" x 36" x 72"	61 lb	67 lb
24" x 42" x 60"	58 lb	63 lb
24" x 42" x 66"	62 lb	68 lb
24" x 42" x 72"	66 lb	73 lb
24" x 48" x 60"	63 lb	69 lb
24" x 48" x 66"	67 lb	74 lb
24" x 48" x 72"	71 lb	78 lb
30" x 36" x 60"	60 lb	66 lb
30" x 36" x 66"	65 lb	71 lb
30" x 36" x 72"	70 lb	77 lb
30" x 42" x 60"	65 lb	72 lb
30" x 42" x 66"	71 lb	78 lb
30" x 42" x 72"	76 lb	84 lb
30" x 48" x 60"	72 lb	79 lb
30" x 48" x 66"	77 lb	85 lb
30" x 48" x 72"	82 lb	91 lb



STAND-ALONE TABLETOPS

Table Weights (Cont.)

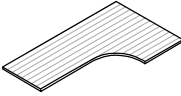
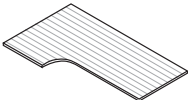
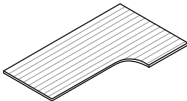
Top Size	Grade 1 Laminate	Grade 2 Laminate		
Left Extended Corner (A x B x C)				
24" x 60" x 36"	52 lb	58 lb		
24" x 66" x 36"	57 lb	62 lb		
24" x 72" x 36"	61 lb	67 lb		
24" x 60" x 42"	58 lb	63 lb		
24" x 66" x 42"	62 lb	68 lb		
24" x 72" x 42"	66 lb	73 lb		
24" x 60" x 48"	63 lb	69 lb		
24" x 66" x 48"	67 lb	74 lb		
24" x 72" x 48"	71 lb	78 lb		
30" x 60" x 36"	60 lb	66 lb		
30" x 66" x 36"	65 lb	71 lb		
30" x 72" x 36"	70 lb	77 lb		
30" x 60" x 42"	65 lb	72 lb		
30" x 66" x 42"	71 lb	78 lb		
30" x 72" x 42"	76 lb	84 lb		
30" x 60" x 48"	72 lb	79 lb		
30" x 66" x 48"	77 lb	85 lb		
30" x 72" x 48"	82 lb	91 lb		
A x B x C x D				
Right Extended Offset Corner				
24" x 36" x 60" x 30"	58 lb	64 lb		
24" x 36" x 66" x 30"	64 lb	70 lb		
24" x 36" x 72" x 30"	69 lb	76 lb		
24" x 42" x 60" x 30"	63 lb	69 lb		
24" x 42" x 66" x 30"	69 lb	75 lb		
24" x 42" x 72" x 30"	74 lb	81 lb		
24" x 48" x 60" x 30"	68 lb	75 lb		
24" x 48" x 66" x 30"	74 lb	81 lb		
24" x 48" x 72" x 30"	79 lb	87 lb		
A x B x C x D				
Left Extended Offset Corner				
30" x 60" x 36" x 24"	58 lb	64 lb		
30" x 66" x 36" x 24"	64 lb	70 lb		
30" x 72" x 36" x 24"	69 lb	76 lb		
30" x 60" x 42" x 24"	63 lb	69 lb		
30" x 66" x 42" x 24"	69 lb	75 lb		
30" x 72" x 42" x 24"	74 lb	81 lb		
30" x 60" x 48" x 24"	68 lb	75 lb		
30" x 66" x 48" x 24"	74 lb	81 lb		
30" x 72" x 48" x 24"	79 lb	87 lb		

LAMINATE COLOR PROGRAM

The following collections are available in the laminate color program: Cameo, Nano, Ocala, Parallon, Paséa, Switchback, Tensor and Uni. No minimum orders or additional costs apply.

Laminates

	Aviera	Composium	Envoi	Gobi	Mezzanine	Visit Modular
Grade 1						
Amber Mahogany	FCW3	FCW3				FCW3
Clear Maple	FCW1	FCW1				FCW1
Columbian	—	—				—
Espresso	FCW4	FCW4				FCW4
Medium Cherry	FCW2	FCW2				FCW2
Skyline	—	—				—
Uptown	—	—				—

LAMINATE COLOR PROGRAM

The following collections are available in the laminate color program: Cameo, Nano, Ocala, Parallon, Paséa, Switchback, Tensor and Uni. No minimum orders or additional costs apply.

Laminates









	Cameo	Nano	Ocala	Parallon	Paséa	Switchback	Tensor	Uni
Grade 1								
Ankara Cherry	—	—	TL18	TL18	—	TL18	TL18	—
Black	—	—	TL19	TL19	—	TL19	TL19	—
Brazilian Walnut	—	—	TL20	TL20	—	TL20	TL20	—
Cabinet Maple	—	—	TL21	TL21	—	TL21	TL21	—
Driftwood	—	—	TL23	TL23	—	TL23	TL23	—
Folkstone Grey	—	—	TL24	TL24	—	TL24	TL24	—
Libretti	—	—	TL25	TL25	—	TL25	TL25	—
Queenston Oak	—	—	TL26	TL26	—	TL26	TL26	—
Sandalwood	—	—	TL27	TL27	—	TL27	TL27	—
Walnut Amati	—	—	TL28	TL28	—	TL28	TL28	—
White	—	—	TL29	TL29	—	TL29	TL29	—
Grade 2								
Classic Linen	TL17	TL17	TL17	TL17	TL17	TL17	TL17	—
Colombian Walnut	TL55	—	TL55	TL55	—	TL55	TL55	—
Crisp Linen	TL64	—	TL64	TL64	—	TL64	TL64	—
Designer White	TL66	—	TL66	TL66	—	TL66	TL66	—
Field Elm	TL13	TL13	TL13	TL13	TL13	TL13	TL13	TL13
Frosty White	TL16	TL16	TL16	TL16	TL16	TL16	TL16	TL16
Grey	TL62	—	TL62	TL62	—	TL62	TL62	—
Grey Elm	TL51	—	TL51	TL51	—	TL51	TL51	—
Kingswood Walnut	TL53	—	TL53	TL53	—	TL53	TL53	—
Manitoba	TL56	—	TL56	TL56	—	TL56	TL56	—
Neo Walnut	TL50	—	TL50	TL50	—	TL50	TL50	—
Platinum	TL61	—	TL61	TL61	—	TL61	TL61	—
Portico Teak	TL60	—	TL60	TL60	—	TL60	TL60	—
Skyline Walnut	TL15	TL15	TL15	TL15	TL15	TL15	TL15	TL15
Steel Mesh	TL59	—	TL59	TL59	—	TL59	TL59	—
Tuscan Walnut	TL57	—	TL57	TL57	—	TL57	TL57	—
Uptown Walnut	TL14	TL14	TL14	TL14	TL14	TL14	TL14	TL14

LAMINATE COLOR PROGRAM

Laminate

Color	Code	
Grade 1		
Ankara Cherry	TL18	
Black	TL19	
Brazilian Walnut	TL20	
Cabinet Maple	TL21	
Driftwood	TL23	
Folkstone Grey	TL24	
Libretti	TL25	
Queenston Oak	TL26	
Sandalwood	TL27	
Walnut Amati	TL28	
White	TL29	

Laminate (Cont.)

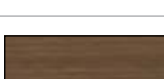
Color	Code	
Grade 2		
Classic Linen	TL17	
Colombian Walnut	TL55	
Crisp Linen	TL64	
Designer White	TL66	
Field Elm	TL13	
Frosty White	TL16	
Grey	TL62	
Grey Elm	TL51	
Kingswood Walnut	TL53	
Manitoba Maple	TL56	
Neo Walnut	MC3	

Laminate (Cont.)

Color	Code	
Grade 2		
Platinum	MC28	
Portico Teak	MC16	
Skyline Walnut	MC15	
Tuscan Walnut	MC37	
Uptown Walnut	MC33	

CARE AND CLEANING

Safety First

To ensure proper cleaning and/or disinfecting, it's important to consult with facilities or safety personnel and follow the manufacturer's instructions—including detailed dilution requirements, safe application instructions, dwell time for effective disinfecting and more.

Per CDC instructions, always read and follow the directions on the label to ensure safe and effective use.

- Wear skin protection and consider eye protection for potential splash hazards
- Ensure adequate ventilation
- Use no more than the amount recommended on the label
- Use water at room temperature for dilution (unless stated otherwise on the label)
- Avoid mixing chemical products
- Label diluted cleaning solutions
- Store and use chemicals out of the reach of children and pets

Always read and follow the directions on the cleaner/disinfectant labels to ensure safe and effective use.

Clean + Disinfect

Cleaning and disinfecting are two distinct actions, and knowing the difference between the two can help promote safety in any space. This comprehensive, 2-step process requires cleaning before disinfecting.

Clean

CLEANING REMOVES GERMS

- The act of removing visible dirt and debris from objects or surfaces
- Cleaning works by using soap/detergent with water to remove impurities from surfaces either manually or mechanically
- Cleaning does not kill germs, but by removing them, it lowers their numbers and risk of spreading infection

Clean (Cont.)

CLEANING GUIDELINES AND TIPS

- Start by lightly dusting with a soft, grit-free cloth or chamois (no wiping)
- After dusting, dampen cloth or chamois with a solution of mild, non-abrasive liquid soap and water
- Wipe clean and dry with a soft, grit-free cloth, sponge or chamois
- Avoid using abrasive cleaners and steel wool to prevent scratching
- Test any cleaning method or agent in an inconspicuous area of the surface

Disinfect

DISINFECTING KILLS GERMS

- This process comes after a surface is cleaned
- Disinfecting kills germs on objects or surfaces with the use of chemicals
- Most common disinfectants include one of the following active ingredients: Quaternary Ammonium (Quats), Sodium Hypochlorite (Bleach), Hydrogen Peroxide, or 70% Isopropyl Alcohol
- EPA-registered disinfectants List N: Disinfectants for Use Against SARS-CoV-2

DISINFECTING GUIDELINES AND TIPS

- Follow the disinfectant manufacturer's instructions when applying the agent
- Once finished, remove all disinfecting agents from the surface with water and a grit-free cloth, then dry
- If not properly removed, disinfectant residue could degrade product life and appearance

Cleaning + Disinfecting efforts should be part of an organization's comprehensive systems-based approach to provide a safe and sustainable workspace.

CARE AND CLEANING

Cleaning Our Hard Surfaces

Over 95% of the hard surfaces on our products can be cleaned/disinfected using any one of the four primary ingredients listed below.

- Bleach (Sodium Hypochlorite)
- Hydrogen Peroxide
- Quaternary Ammonium Compounds (Quats)
- 70% Isopropyl Alcohol

EXAMPLES OF HARD SURFACES THAT CAN BE DISINFECTED:

- Plastics (i.e. polyurethane and acrylic)
- Solid Surface
- Metals
- Painted Surfaces
- Laminate

EXCEPTIONS:

- Markerboard
- Veneer
- Wood Surfaces

Clean + Disinfect

Cleaning and disinfecting are two distinct actions, and knowing the difference between the two can help promote safety in any space. This comprehensive, 2-step process requires cleaning before disinfecting.

Cleaning Our Soft Surfaces

Our textiles and meshes offer a performance and cleaning story unmatched in the industry.

Our Carded Textile Program offers over 700 bleach-cleanable fabrics through our SitOnIt Seating private label and partnership textile program.

MESH:

- All of our mesh materials are bleach-cleanable. This determination is supported by 3rd-party results from completing AATCC 188 Colorfastness to Bleach testing where the subject material is submersed, and friction stirred in a diluted sodium hypochlorite solution.
- Cleaning of our mesh materials varies. Check out the [Mesh Spec + Care Guide](#) on our website for more information.

SEATING FABRICS:

- Soft surfaces on seating can vary widely from woven, knits and leather to coated textiles such as vinyl and polyurethane. Woven and knits tend to be more permeable than vinyl or polyurethane.
- Cleaning of our seating fabric materials varies. For a list of our textile spec + care guides, see the [Materials Downloads](#) on our website.
- For a list of bleach-cleanable materials, see our [Carded Library](#) and select "Bleach Cleanable" under performance.

SCREEN FABRICS:

- Cleaning of screen materials varies. For a list of our textile spec + care guides, see the [Materials Downloads](#) on our website.
- For a list of bleach-cleanable materials, see our [Carded Library](#) and select "Bleach Cleanable" under performance.