

SitOnIt • Seating®

2018 Price Guide



SitOnIt • Seating®

CALIFORNIA BORN AND BRED

We're a leading manufacturer of commercial solutions in the U.S.—and #1 in task chairs. From tables and lounge to screens and more, we've been the go-to destination for comprehensive, build-to-order solutions for almost 25 years.

We combine award-winning design with the fastest lead times around (choose from 2-, 5- or 10-day shipping). We can build almost any specification you want, deliver it when you need it and offer a price no one can match. It's all part of our indie California spirit and drive to help you do more.

DESIGN THAT GETS YOU

Discover seating engineered around you. Experience responsive design, supreme comfort and hyper-customizable features—all at value-driven prices.

OUR BUILD-TO-ORDER PROMISE

Custom-designed chairs, no waiting. Our nimble size and lean manufacturing operation means we can ship build-to-order chairs in just two days.

FASTEST SHIPPING IN THE INDUSTRY

Choose from two, five, or 10 day shipping. We cut lead time, sync orders and avoid off-schedule shipments at a rate our competitors just can't match.

WORLD-CLASS SERVICE

We're proud to announce that the Office Furniture Dealer Alliance voted for us as "Best Customer Service" three times in the past five years.

TABLE OF CONTENTS

Intro

Table of Contents	2
Sustainable Design.....	8
Warranty	9
Ordering Information	12
CAL 133.....	15
Fabric	17
COM/COL.....	18
COM/COL Test Request Form	19
Custom Upholstery Form	20
COM Calculation	21
COM/COL Tardage: Task and Conference.....	22
COM/COL Yardage: Multipurpose and Side	26
COM/COL Yardage: Lounge	29
Custom Finish Program.....	32
Care and Cleaning.....	33
Glide Guide.....	35
Stacking Guide.....	36
Heavy Duty Series	38

Task, Light Task, Executive and Conference Chairs and Stools

Amplify

Mesh Back Task Chair.....	44
Mesh Back Task Stool.....	48
Upholstered Back Task Chair.....	52
Upholstered Back Task Stool.....	56

Anytime

Light Task Chair and Task Stool.....	59
--------------------------------------	----

Focus

Mesh Back Task Chair.....	62
Mesh Back Task Stool.....	67
Upholstered Back Task Chair.....	71
Upholstered Back Task Stool.....	76

Focus 2.0

Mesh Back Task Chair.....	80
---------------------------	----

Glove Active

Conference Chair	84
------------------------	----

Glove Executive

Conference Chair	88
------------------------	----

InFlex

Light Task Chair and Task Stool.....	91
--------------------------------------	----

Ioniq

Collaborative Chair.....	95
--------------------------	----

TABLE OF CONTENTS

Task, Light Task, Executive and Conference Chairs and Stools

Knack

Task Chair.....	98
Task Stool.....	102

Lumin

Light Task Chair and Task Stool.....	105
--------------------------------------	-----

Mavic

Collaborative Chair.....	109
--------------------------	-----

Movi

Light Task Chair and Stool.....	112
---------------------------------	-----

Non-Stop

Heavy Duty Task Chair.....	115
Heavy Duty Task Stool.....	118

Novo

Mesh Back Task Chair.....	121
Mesh Back Task Stool.....	126

OnCall

Light Task Chair and Task Stool.....	130
--------------------------------------	-----

Prava

Conference Chair.....	134
-----------------------	-----

ReAlign

Task Chair.....	138
Task Stool.....	142

Relay

Light Task Chair and Task Stool.....	145
--------------------------------------	-----

Rio

Light Task Chair and Task Stool.....	149
--------------------------------------	-----

Sona

Conference Chair.....	153
-----------------------	-----

Torsa

Task Chair.....	157
-----------------	-----

TR2

Task and Executive Chair.....	161
Task Stool.....	165

Vectra

Mesh Back Task Chair.....	169
---------------------------	-----

Wit

Mesh Back Task Chair.....	173
Mesh Back Task Stool.....	177
Thintex Back Task Chair.....	181
Thintex Back Task Stool.....	185

TABLE OF CONTENTS

Multipurpose, Side and Guest Chairs ; Counter and Bar Stools

Achieve

Multipurpose Chair.....	193
-------------------------	-----

Anytime

Multipurpose Chair and Bar Stool.....	196
---------------------------------------	-----

Baja

Multipurpose Chair and Bar Stool.....	199
---------------------------------------	-----

Focus Side

Multipurpose Chair, Counter and Bar Stool	203
---	-----

Freelance

Multipurpose Chair, Counter Stool and Bar Stool.....	208
--	-----

Bariatric Chair	213
-----------------------	-----

InFlex

Multipurpose Chair, Counter Stool and Bar Stool.....	216
--	-----

Ioniq

Guest Chair	220
-------------------	-----

Multipurpose Chair.....	222
-------------------------	-----

Kickstand

Stool	224
-------------	-----

Lumin

Multipurpose Chair, Counter Stool and Bar Stool.....	226
--	-----

Mika

Multipurpose Chair and Bar Stool.....	230
---------------------------------------	-----

Movi

Nester Chair	233
--------------------	-----

OnCall

Multipurpose Chair and Bar Stool.....	236
---------------------------------------	-----

Qwiz

Nester Chair	239
--------------------	-----

Relay

Multipurpose Chair.....	243
-------------------------	-----

Relay

Nester Chair	246
--------------------	-----

Rio

Multipurpose Chair, Counter and Bar Stool	249
---	-----

Rowdy

Multipurpose Chair.....	253
-------------------------	-----

Wit Side

Mesh Back Multipurpose Chair.....	256
-----------------------------------	-----

Thintex Back Multipurpose Chair.....	260
--------------------------------------	-----

TABLE OF CONTENTS

Lounge

Aviera

Guest and Bariatric Seating	270
Hip Chair	275
Patient Seating	279
Freespan Multiseating	284
Preconfigured Tandem Multiseating.....	289
Start/Center/End Tandem Multiseating.....	294
Linking Tables.....	299

Cameo

Seating and Benches	302
Inline and Coffee Tables	307

Composium

Curve Club Chair, Settee and Sofa	309
Flair Club Chair, Settee and Sofa	314
Sharp Club Chair, Settee and Sofa	319
Ottoman and Benches	324

Envoi

Lounge Seating	329
----------------------	-----

Gobi

Lounge Seating	333
----------------------	-----

Nano

Modular Lounge Typicals	336
Modular Lounge	342

Paséa

Modular Lounge Typicals	346
Modular Lounge	351
Tables and Ottomans	359
Inline Tables.....	363

Visit Modular

Lounge Seating	366
----------------------	-----

TABLE OF CONTENTS

Tables and Desks

Mezzanine

Cube End Table, Coffee Table and Corner Table	374
Occasional Table	377

Ocala

Flip-Top Tables	380
-----------------------	-----

Switchback

2-Leg Height-Adjustable Table Bundle	383
2-Leg Height-Adjustable Table.....	388
3-Leg Height-Adjustable Table Typical.....	392
3-Leg Height-Adjustable Table.....	395

Tensor

Café, Classroom, and Office Typical.....	404
Café Table	407
Multipurpose Table.....	410
Desking	413

Voyager

2-Leg Height-Adjustable Table.....	420
3-Leg Height-Adjustable Table.....	424

Benching

Prise

Benching Typical.....	430
-----------------------	-----

Prise

Benching	435
----------------	-----

Screens

Doodle

Markerboard Worksurface Screen	447
--------------------------------------	-----

Modesty

Worksurface Screen	450
--------------------------	-----

Motif

Fabric Worksurface Screen.....	452
Mobile + Freestanding Fabric Screens	458

Sector

Acrylic Worksurface Screens	461
Scrylic Café Screens	464
Acrylic Seating Screens	466
Acrylic Transaction Screen.....	469
Tri-Fold Acrylic Meeting and Single-Table Screen	471

TABLE OF CONTENTS

Monitor Arms

King Cobra

Monitor Arm	476
-------------------	-----

Mobio

Monitor Arm	478
-------------------	-----

Unity G2

Monitor Arm	481
-------------------	-----

Accessories

Anti-Fatigue Mat	484
CPU Storage	485
Keyboard Tray	486
Laptop Storage	487
Lighting: Rhythm	488
Mobile Pedestal	489
Pencil Storage	491
Power: Current	492
Sit-to-Stand: High Tide	493
Wire Management	494

Appendix

Stand-Alone Tabletops	495
Color Program	498
Arm Adjustments	500
Mechanism Functions	504
Executive and Conference Chair Options	507
Task Chair Options	508
Task Stool Options	512
Multipurpose Chair Options	514
Multipurpose Stool Options	516
Heavy Duty (350 lb) Options	517
Large and Tall Option and Extra Large Options	518
Extra Large and Bariatric Side Options	519

SUSTAINABLE DESIGN

We make it easy to go green. Design an eco-friendly room from the ground up or upgrade an existing space to meet the latest environmental standards.



ANSI/BIFMA Certified

SitOnIt Seating is a member of the Business and Institutional Furniture Manufacturer's Association (BIFMA). Tests developed by BIFMA are approved by the American National Standards Institute (ANSI) to determine the strength and durability of seating. Although testing is not a warranty or guarantee, our task, side and lounge products meet or exceed BIFMA and ANSI standards.



Leed Certified

Earn points toward LEED certification thanks to our U.S. manufacturing location and our use of recycled materials where possible.



GREENGUARD Certification

All SitOnIt Seating lounge and seating products met the rigorous criteria required by GREENGUARD Gold in accordance with the Collaborative for High Performance Schools.



Level Certified

Sustainability matters. That's why we've worked to achieve BIFMA level® certification for all task chairs, side chairs and lounge products.



The Take Back Program

SitOnIt Seating helps minimize product waste by connecting our customers and dealers with third-party groups who redirect materials that would be headed for the landfill to local nonprofits and public agencies.



We Did Our Homework

Download detailed documents that break down the percentage of recycled content, manufacturing processes and indoor air emissions for every chair we make.

WARRANTY

Product Warranty Periods

Exemplis LLC, d.b.a. SitOnIt Seating (hereafter referred to as the Company), warrants to the original end user that this product will be free from defects in its material and workmanship when used in a single shift (standard eight-hour day, five days per week) for the following warranty periods:

LIFETIME WARRANTY COVERAGE:

- All SitOnIt Seating products, except where noted below
- Structural Components: Prise, Switchback and Voyager

12-YEAR WARRANTY COVERAGE:

- Amplify, Torsa, Wit and Novo used in multi-shift (24/7) applications
- Lounge seating and occasional/lounge tables
- Bases: Ocala, Tensor
- Laminate tops
- Monitor arms¹: King Cobra, Mobio series, Unity G2
- Plastic shells

10-YEAR WARRANTY COVERAGE:

- Non-Stop Heavy Duty, Freelance Bariatric and chairs purchased with a Heavy Duty (HD) or Large and Tall (LT) option used in multi-shift (24/7) applications
- Electrical Components²: Prise

SEVEN-YEAR WARRANTY COVERAGE:

- Electrical Components²: Switchback and Voyager

FIVE-YEAR WARRANTY COVERAGE:

- Fabric, foam, knit back, mesh and mesh
- All filing products³
- CPU holders
- Screens⁴
- High Tide
- Keyboard trays
- Lighting fixtures
- Power components⁵: EON, Current, Power Strips
- Wire management

TWO-YEAR WARRANTY COVERAGE:

- Fabric and foam cushioning for Non-Stop Heavy Duty, Freelance Heavy Duty and chairs purchased with an HD or LT option
- Multipurpose felt glides
- Half-Moon Pencil Drawer

ONE-YEAR WARRANTY COVERAGE:

- Lighting power supplies
- Mouse pads
- Wrist rests

1. Weight capacity of the monitor arms must be followed. If an arm is not functioning properly because of the weight of the monitor is outside of the advertised weight capacity, the monitor arm will not be considered defective under the warranty.

2. Please note that electrical components on a height-adjustable table include: hand controls, motors, control boxes and electrical cables.

3. This warranty does not cover damage from ordinary wear and tear, including paint finish changes and/or discoloration resulting from aging or exposure to light.

4. Warranty limited to finishes, tacking surface of tack boards and writing surface of whiteboards. Standard textiles limited to original manufacturer's warranty.

5. Power components are defined as any power unit with electrical outlets and/or USB/data connections, connector jumper cables for daisy chain and infeeds for hardwire applications.

WARRANTY

Freight Warranty

At SitOnIt Seating™, we take pride in crafting one-of-a-kind pieces. Products are thoughtfully inspected prior to being carefully wrapped and packed for shipment. Upon receiving your order, should your order be less than perfect, please follow these steps for an expedited resolution:

IF DAMAGE IS VISIBLE:

- Please accept shipment and report damages on the freight bill.
- Contact SitOnIt Seating Customer Experience to report the issue **within 10 days** after delivery.

IF DAMAGE IS CONCEALED:

- Save merchandise and packaging.
- Take a photo to document the damage.
- Contact SitOnIt Seating Customer Experience to report the issue **within 60 days** after delivery.

Either way, we are here to help! SitOnIt Seating Customer Experience Team is on standby to assist Monday through Friday, 5:00 a.m. to 5:00 p.m. PST. Call (888) 274-8664 or email sitonit@exemplis.com.

The Company Does Not Warranty

- COM/COL textiles
- Product abuse or misuse
- Failure resulting from normal wear and tear
- User modification of or attachments to the product
- Products or parts not used, maintained or installed in accordance with the Company's installation, maintenance and/or applicable guidelines
- Products that are exposed to extreme environmental conditions and/or have been subject to improper storage
- Floor samples or display models
- The substitution or use of non-SitOnIt Seating components with SitOnIt Seating products
- Products purchased "as is" and/or secondhand
- Products sold by unauthorized dealers
- Creasing and/or gathering of textiles during upholstery application process
- Minor irregularities of color, surface, grain and texture
- Minor variations of color in textiles
- Variations of texture and natural markings such as neck wrinkles, scratches, backbone marks and stretch marks in leather
- Color matching of textiles exactly to samples, swatches or prior purchases

WARRANTY

Applicable Provisions To All Products And Services

The Company will repair or replace with a comparable product, at its option, without charge to the original purchaser, only defective products or parts found defective during the Warranty Period. If requested by the Company, the original purchaser must return the part or product with freight or other shipping charges prepaid.

This warranty shall be effective for the applicable time period beginning from date of purchase as shown on original purchaser's original receipt or other proof of purchase.

For products purchased on or after August 1, 2012, the Company shall pay for all labor costs pre-approved by the Company. The payment of such pre-approved labor costs will be in the form of a credit to an active Company account.

There are no other warranties, expressed or implied, other than those specifically described, including, without limitations, any implied warranty or merchantability or of fitness for a particular purpose. The Company will not be responsible for incidental or consequential damages. Some states do not allow the exclusion or limitation of incidental or consequential damages, so the above limitations or exclusions may not apply to you. This warranty gives you specific legal rights and you may have other rights which vary from state to state.

Warranty claims must be reported within 60 days of any concealed damage. The Company will advise you of the procedure to follow when making warranty claims. Call the Company at the number below to explain the defect. Give your name, address and telephone number. Please be prepared with the model number and sales order number found under the seat of the chair.

SitOnIt Seating: (888) 274-8664

ORDERING INFORMATION

Pricing

All prices are suggested retail and are subject to change without notice. Visit our websites or contact Customer Experience for the latest pricing. Prices in effect at the time of shipment will prevail. We reserve the right to make changes in prices, models, fabrics, finishes, materials and specifications and also discontinue models and options at any time without notice.

Orders

Specify model number, quantity, desired delivery date and all other applicable information. Order templates can be found in the applicable Price Guide. Orders will be accepted with an acknowledgment form governing the transaction. In the event an error is made in the manufacture of the product, the acknowledgment will be used as the resolution document. Submit orders by email or fax:

SITONIT SEATING:

Email: purchaseorder@exemplis.com

Fax: (714) 995-4855

Minimums

TASK AND SIDE CHAIRS

There is no minimum requirement. Standard transportation freight costs are included in the price of the product.

LOUNGE

The freight program is designed to be delivered freight prepaid to the designated consignee, based upon a minimum of three or more items. If the shipment does not meet the minimum unit requirement, a surcharge of \$95 net per shipment will be assessed.

TABLE SURFACES

Any order containing surfaces must have a minimum quantity of four or order will incur a \$95 freight fee.

Quantity Discounts

Quantity discounts for CAL 133 textiles and some shipping methods are available. See the appropriate Price Guide or contact Customer Experience for more information.

Change Orders

Orders that have been scheduled for production may not be changed. All changes on customer orders previously acknowledged must be requested in writing and are subject to approval. Requests for changes are not deemed accepted until acknowledged. In the event a revision is accepted, change fees may apply.

Lead Time

We have thousands of carded textiles—including vinyl and leather—that ship in two, five or 10 days. For a complete listing of textile lead times, see the Carded Textile Program section of the Textile Reference Guide or visit the Materials tab on our websites. Graded-in, COM and COL orders start production when the textile arrives from the manufacturer. Because of this the lead time on Motif screens or upholstered chairs is two, five or 10 days based on the textile selection.

TWO-DAY

- Anti-Fatigue Mat
- Corner Sleeve
- CPU Holders
- Current power
- High Tide
- Keyboard Mechanisms (Lift and Lock, Premium Lift and Lock, Sit-to-Stand)
- Keyboard Trays (Longboard, Crescent Board, Mini Platform, Laptop Tray, Adapter)
- Laptop Drawer
- Mobile Pedestals
- Monitor Arms
- Ocala Bases
- Pencil Storage
- Plastic Shells
- Switchback Bases
- Tensor Bases
- Value Lighting
- Voyager 2-Stage/3-Leg Bases
- Wire Management

THREE-DAY

- Doodle Screens
- Mobile Pedestal Cushions
- Modesty Screens
- Motif Screens
- Prise Benching
- Sector Screens
- Standard Worksurfaces

10-DAY

- Lounge

15-DAY

- Stain-to-Match

21-DAY

- Tablet Arm

30-DAY

- Custom Laminates

ORDERING INFORMATION

Lead Time

Large orders may require additional lead time:

25 UNITS

- Cameo
- Compositum
- Envoi
- Gobi
- Nano
- Paséa
- Visit Modular

50 UNITS

- Aviera
- Benching
- Screens
- Tabletops
- Tensor Bases

150 UNITS

- Accessories
- Height-Adjustable Table Bases
- Lighting
- Monitor Arms
- Ocala Bases
- Power
- Sit-Stand (Desktop)

250 UNITS

- Task Chairs/Stools
- Side Chairs/Stools

Orders received by 10 a.m. PST begin assembly the next day. Orders that are “On Hold” will begin production only when all holds are released. Types of holds include:

- Credit Hold for issues related to billing and invoicing.
- Incomplete Hold if the purchase order is incomplete or illegible.
- Pricing Hold if the price on the purchase order does not match the pricing shown in the Price Guide or in our computer system.
- New Fabric Hold for nonstandard textile orders without an inventory part number.
- Graded Hold is placed by the Purchasing Department while confirming delivery of graded fabric from the vendor.

Customer Experience will notify you of any holds placed on your order.

Product Modification

Special requests are available and additional charges will be determined per quotation. Up to five working days are required after the special request is received to prepare a quotation. Contact Customer Experience for details.

Orders for Parts

Multiple shipments may occur for orders that include parts. Hardware such as casters or cylinders will ship separately from items requiring upholstery or manufacturing labor. Components such as casters or cylinders will ship separately from new chairs.

Product and Design Changes

We reserve the right to discontinue product lines, models and parts at any time. We also reserve the right to make changes in design and material when such action is deemed to be an improvement in design, function and/or construction.

Cancellation and Returns

Orders that have entered any stage of production cannot be canceled. Request for cancellations are not accepted until acknowledged. In the event a cancellation is accepted, canceled charges may be imposed for the entire amount of the order. Authorization for return must be requested from and approved by Customer Experience prior to the return of the merchandise. Returns may be subject to a restocking charge equivalent to 40% of the net order plus freight. Unauthorized returns will not be accepted.

Shipping

Standard shipments are made via common carrier, unless otherwise specified. Special routing requests made by the customer or the consignee may result in additional charges.

Standard deliveries are dock-to-dock and are scheduled to occur Monday through Friday between 8 a.m. and 5 p.m., based on our published transit times. We will not be held responsible for issues or costs arising from carrier transit delays, missed delivery appointments, etc.

We reserve the right to charge for nonstandard customer delivery requirements that may include order deliveries, inside deliveries, etc. For information concerning these charges, contact Customer Experience.

ORDERING INFORMATION

Freight Terms

Freight terms apply to the continental U.S. only. This excludes Alaska and Hawaii. All standard transportation services and freight costs are included in the price of our products. We ship freight prepaid and allowed, FOB and origin.

Shipments outside the contiguous U.S. are shipped to the point of embarkation free of charge, if the shipment meets the minimum requirement. All subsequent freight charges will be at the customer's expense, shipped collect.

Because of the fluctuation of fuel prices, we reserve the right to impose fuel surcharges for any shipments.

Freight Damage

We are not responsible for product damage occurring in transit or during storage. Before accepting a shipment from the carrier, carefully review the packing list and inspect the quantity and condition of the items. Promptly document all visible damage on the Bill of Lading and request a carrier inspection of the product. In the event of damage, accept the order and contact Customer Experience for issue resolution. Concealed damage must be reported in writing within 60 days of accepting delivery. We will take all reasonable steps to assist customers in resolving claims for loss or damage.

Smart Delivery

Smart Delivery provides precise order delivery within a customer-specified date and time window. This special service is available in the contiguous U.S. and includes inside delivery, non-dock delivery, weekend delivery and residential delivery.

Requests must be made prior to an order being scheduled for production. A Smart Delivery fee will be added to the original order invoice. Any changes to a submitted Smart Delivery order will require a new Smart Delivery quote request. Not all change requests can be honored. Changes to an order will result in delays and/or additional costs once the order is in transit.

The Smart Delivery fee will be refunded if the shipment does not arrive within the specified delivery window. We will not be held responsible for costs or damages associated with delayed deliveries.

Please contact Customer Experience to request a Smart Delivery quote or for more information.

Will Call

Customers with Will Call orders will be notified once orders are ready to be picked up. Customers will have three business days from notification to pick up the order. If the order is not picked up within this time frame, storage charges will start at a rate of \$30 per business day until the order has been claimed.

Invoicing

Invoicing is triggered when the product ships.

Fire safety is a top priority for us. SitOnIt Seating strongly supports CAL 133 standards and makes it easy for designers and buyers to specify CAL 133 chairs.

TB 117

Under California law, all upholstered furniture must meet TB 117-2013 by January 1, 2015. At a minimum, all SitOnIt Seating fabrics, vinyl, leathers and resilient filling material (i.e., foam and Dacron) meet TB 117-2013. Unlike TB 117-2013, which tests only the inner upholstery components, with CAL 133 the entire piece of furniture must withstand ignition from a gas burner inside a testing chamber.

What is CAL 133?

CAL 133 is a standard of furniture flammability started by the California Bureau of Home Furnishings and Thermal Insulation for furniture used in public buildings such as healthcare facilities, convalescent homes, public assembly areas of hotels and motels, hospitals, board and care homes, stadiums, licensed child care facilities, prisons and jails.

Notice: Starting January 1, 2020, the State of California changed regulations to ban flame retardants in upholstered furniture sold in California. We anticipate further regulatory changes in other states. The TB-133 barrier material used in our products is a flame-retardant fabric designed to pass open-flame testing protocols. The cotton/fiberglass knit is infused with a phosphorus flame retardant and coated with a chemical that expands in heat to create a physical flame barrier. The TB-133 barrier material that we use in our products is free of halogenated flame retardants, polybrominated diphenyl ethers (PBDE), formaldehyde, and antimony.

Choosing CAL 133 Textiles

Consult the individual SitOnIt Seating fabric cards to review the specifications for each fabric offered. Because we offer such a vast array of fabrics with varying degrees of flame retardancy, we suggest you consult the published technical data of the fabric supplier when making your fabric selection.

Specify CAL 133 textiles in the Material section of the Final Price Calculation worksheet or on your purchase order.

SitOnIt Seating assumes no responsibility for the flame retardancy of any customer-provided textile.

CAL 133 Testing

CAL 133 is a full-scale fire test for furniture manufactured for use in public buildings. The standards do not specify how to construct furniture, but only how it should perform when tested. To pass this fire standard test, a fire blocking liner is sandwiched between the foam and the fabric of our chairs. This liner acts as a fire extinguisher by smothering the flame.

COM/COL compliance for the CAL 133 models listed on the following page can be determined by specifying upholstery with the exact characteristics as approved SitOnIt Seating fabrics and leathers or by conducting a full chair burn test. The nondiscountable test fee for each chair-textile combination is listed below. The lead time for testing is four weeks.

Task and Side Chairs/Stools: \$600
Lounge: \$800

For more information on TB 117-2013 and CAL 133, visit the [State of California Department of Consumer Affairs](#) website.

To Order CAL 133

Allow a 10-day lead time. Clearly specify CAL 133 on your order. For each chair, add the appropriate additional charge.

CAL 133 Materials

- **CAL 133 LEATHER:** All carded leather is CAL 133 approved.
- **CAL 133 PLASTIC:** All our plastic chairs are CAL 133 approved except for our Achieve and Baja collections.
- **CAL 133 TEXTILES:** Over a thousand CAL 133 approved textiles in all grades, colors and styles are listed on the SitOnIt Seating website. Visit sitonit.net and search textiles by CAL 133 compliance, manufacturer, grade, lead time and other attributes.

To Check Seating for CAL 133

To determine whether your current SitOnIt Seating chair meets CAL 133, or to check an order you have recently received, check the bottom of the chair seat pan for the label shown below. If your chair does not have this tag, your chair does not meet CAL 133.

NOTICE

This Article is manufactured for use in public occupancies and meets the flammability requirement of California Bureau of Home Furnishings technical bulletin 133. Care should be exercised near open flame or with burning cigarettes.

CAL 133 Approved Models

The following models, when combined with approved textiles and blocker, meet the CAL 133 standard.

MULTIPURPOSE CHAIRS AND STOOLS

- Achieve: Upholstered
- Anytime: Upholstered and all plastic colors - A48, A49 (arm and armless)
- Focus Side: Upholstered and all mesh colors - A130 (arm and armless)
- Freelance: Upholstered and all plastic colors (arm and armless)
- InFlex: Upholstered and all plastic colors: A121, A122 (arm and armless)
- Lumin: Upholstered and all plastic colors
- Mika: All models
- Movi: All mesh colors
- Non-Stop Heavy Duty: A67, A68, A69, A70, A71, A72 (arm and armless)
- OnCall: Upholstered and all plastic colors - A37FR, A42FR (arm and armless)
- Qwiz: All models
- ReAlign: A73, A74, A75, A76, A77 (arm and armless)
- Relay: Upholstered and all plastic colors - A60, A61 (arm and armless)
- Rio: Upholstered and all plastic colors (arm and armless)
- Rowdy: Upholstered and all plastic colors - A47 (arm and armless)
- Wit Side: All mesh colors (arm and armless)

CAL 133 Approved Models

TASK CHAIRS AND STOOLS

- Amplify: Upholstered and all mesh colors
- Focus: A91, A92, A93, A94, A95 (arm and armless)
- Glove Executive: A26FR
- Glove Active: A26FR, A27FR, A27LFR, A28FR, A28LFR
- Knack: A77, A80, A81 (arm and armless)
- Mavic: All models
- Novo: All mesh colors (arm and armless)
- Prava: A105, A106, A108, A109, A111, A112 (arm and armless)
- Sona: A101, A102, A105, A106, A108, A109 and all knit colors (arm and armless)
- Torsa: All mesh colors (arm and armless)
- TR2: A12FR, A15FR, A17FR, A43FR, A44FR (arm and armless)
- Wit: All mesh colors (arm and armless)

LOUNGE SEATING

- Aviera: Metal and Wood
- Cameo
- Composium
- Envoi
- Gobi
- Nano
- Paséa
- Visit Modular

Unmatched Matching®

Textiles can be everything. With the right fabrics, you can provide atmosphere, create cohesiveness and offer an unforgettable experience across many spaces and places.

Fabric color, alignment, texture, orientation and pattern all play a part—and need to line up or match perfectly (especially with field-replaceable parts). With PatternMatch and pattern orientation, you can rest assured that every part of every chair can be traded out easily without disrupting design.

PatternMatch®

We ensure that design elements of the back, seat and arms match and/or align between seat and back. The patterns or lines also match unit-to-unit.

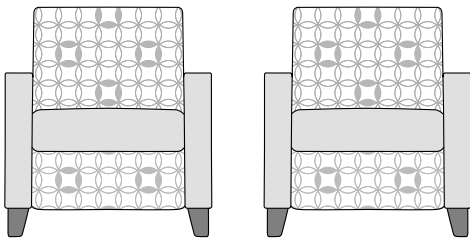

Pattern Orientation

All fabric (vertical, horizontal or bi-directional pattern) will be applied in the direction shown on the fabric manufacturer's website, unless otherwise specified.

To ensure desired fabric direction, use the Custom Upholstery Order Form on page 20 and check the appropriate box under the "Pattern Orientation" section.

When we apply a textile pattern with lines at a 90-degree angle (vertically and/or horizontally) to the back and seat of a chair, we strive to achieve full alignment. Some small variations can occur due to the shape and size of the product. Pattern Orientation is standard for SitOnIt Seating.

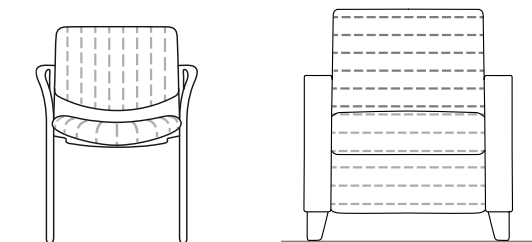

Multi-Upholstery

The multi-upholstery option allows one fabric to be selected for the back and a different fabric for the seat. Multi-upholstery lounge pricing is different than multi-upholstery pricing for task and side seating.

TASK AND SIDE

- Upholstery pricing is based on both seat and back being the same textile. Otherwise:

If two fabrics of the same grade are chosen,

one grade level will be added to the upholstery price.

Example: grade 4 for the seat and a different grade 4 for the back, the upholstery price will be grade 5 for both.

If two fabrics of different grades are chosen,

the final upholstery price will be based on the highest grade. Example: grade 2 for the seat and grade 3 for the back, the upholstery price will be grade 3 for both.

LOUNGE

- A standard upcharge applies to all multi-upholstery orders. Different fabrics and grades may be combined because each back, seat, arm and valance are separately priced.
- Add the single multi-upholstery upcharge to the cost of the components. Example: upcharge + any grade price for the seat + any grade price for the back + any grade price for the arm.

Moisture Barrier

Accidents happen. To help protect your investment, moisture barrier for seats and backs is an option on all lounge seating products.

Specify moisture barrier seats and/or backs in the Material section of the Final Price Calculation worksheet or on your purchase order. Note that specification and pricing are separate for seat and back and apply to each single seat or back position.

COM/COL Warranty

Any textiles applied to furniture orders through the COM/COL process will not be covered under warranty by SitOnIt Seating. Any warranty claims for these upholstery materials will fall to the original vendor of the fabric. With a broad spectrum of harsh cleaning agents used by facilities, SitOnIt Seating recommends that the owner test each fabric selection with their specific cleaning methods before using. Additionally, SitOnIt Seating is not held responsible for receipt of defective fabrics, as we apply all COM as first-quality goods.

CAL 117 Policy

SitOnIt Seating assumes no responsibility for the fire retardancy of any COM/COL. Customers are solely responsible for making sure that their COM/COL complies with all applicable codes and regulations. For information on CAL 133, refer to page .

COM/COL Excess Yardage

SitOnIt Seating is not responsible for yardage submitted to us beyond the required amount. Excess COM/COL materials will be discarded at the discretion of SitOnIt Seating unless otherwise instructed by the customer at the time the order is placed. If a customer requires the COM/COL excess yardage returned, they must contact Customer Experience to make arrangements. The customer will be responsible for delivery charges.

COM/COL Process

1. Visit the **SitOnIt Seating Textile Compatibility** tab on our website to see if your COM/COL textile has already been approved.

(If your textile is already approved, skip to step 3. If it hasn't been previously approved, go to step 2.)

2. Send a 12" x 12" textile swatch to be tested for approval along with a completed COM/COL Test Request Form found on the next page.

Note: Freelance back, InFlex back, Focus Side back and Achieve back require 0.75 yards of fabric to be sent for testing.

Allow two business days once your textile is received for the test results to be available on the **SitOnIt Seating Textile Compatibility** tab on our website.

Send the textile swatch and form to:

SITONIT SEATING

Attn: COM Engineer
6280 Artesia Blvd.
Buena Park, CA 90620

3. If the COM/COL swatch is approved, fill out the Customer Upholstery Form located on page page 20. and attach with your order.
4. Ship the necessary amount of COM or COL material and the purchase order number to:

SITONIT SEATING

Attn: COM Engineer
6280 Artesia Blvd.
Buena Park, CA 90620

COM/COL TEST REQUEST FORM

Please complete one form for each model and/or textile that needs to be tested.

Contact Information

Dealer _____ Contact Name _____

Address _____ City _____ State _____ Zip _____

Phone _____ Fax _____ Email _____

Product Information

Product Name _____ Model Number _____

Textile Information

Manufacturer _____ Pattern _____ Colorway _____

Shipping Information

The 12" x 12" textile swatch and this form can be sent to:

SITONIT SEATING
Attention: COM Engineer
6280 Artesia Blvd.
Buena Park, CA 90620

Please allow five business days once the fabric is delivered for your test results to be available on the **SitOnIt Seating Textile Compatibility** tab of our website. If you need further assistance, please contact Customer Experience at (888) 274-8664.

Note: Freelance back, InFlex back, Focus Side back and Achieve back require 0.75 yards of fabric to be sent for testing.

CUSTOM UPHOLSTERY FORM

For all COM/COL orders or standard orders with custom textile upholstery directions, please complete one form for each model and/or textile.

Contact Information

Dealer _____ Contact Name _____
 Address _____ City _____ State _____ Zip _____
 Phone _____ Fax _____ Email _____

Order Information

Purchase Order Number _____ Sales Order Number _____

Product Information

Product Name _____ Model Number _____ Quantity _____

Textile Information

Manufacturer _____ Pattern _____ Colorway _____

Total Yardage Shipped (for COM/COL) _____

(To calculate, reference COM Calculation and COM Yardage Requirement beginning on page 21.)

Contains flame retardants: Yes No **Prop 65 compliant:** Yes No

Per California Proposition 65, we are required to note that select textiles may contain chemicals known to cause cancer or reproductive toxicity. To learn more, please visit the Prop 65 web page.

Fabric Direction

To avoid confusion, you may wish to attach a sample textile with the desired face and direction indicated. Is there a desired top and bottom to the fabric application?

Yes No

Is the fabric either a stripe or two-color plaid?

Yes No

Please refer to our standard and rotated fabric directions to the right. Indicate the desired fabric direction for each applicable component below.

Seat (Ottoman Chassis):	Vertical	Horizontal
Back (Ottoman Top):	Vertical	Horizontal
Arm:	Vertical	Horizontal
Valance:	Vertical	Horizontal

Please attach this form with your order submission.
 If you are submitting a COM/COL order, make sure to include your PO# with the textile that you mail to our factory:

SITONIT SEATING

Attn: COM Engineer
 6280 Artesia Blvd.,
 Buena Park, CA 90620

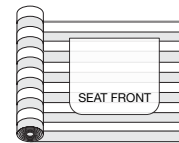
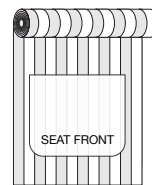

Vertical or Off the Roll

Horizontal or Railroaded

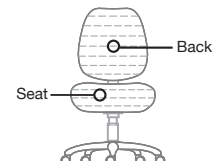
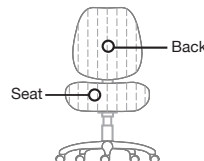
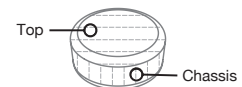
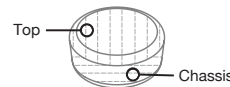
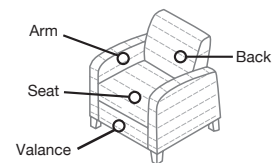
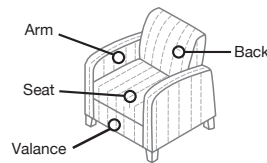

Steps to Calculate COM Yardage.

1. Determine which products are being ordered as COM.
2. Find the yardage needed to upholster those products from the COM Yardage Requirement charts.
3. Adjust the yardage requirement total based on the repeat of the fabric roll using the COM Repeat Calculation table.
4. Take the final calculation and round up to the nearest half-yard to get final yardage.

For orders of 10 or more seats, contact Customer Experience for further quoting.

COM Repeat Calculation.

Use the guide below to calculate the percentage of extra upholstery required to cover large repeats.

Repeat	Railroaded/Horizontal OR Vertical/Off The Roll
5.1"– 7"	10%
7.1"–10"	15%
10.1"–14"	20%
14.1"–20"	30%
20.1"–27"	45%

Yardage requirements listed in this document are based on textile bolts/rolls that are 54" wide. Please contact Customer Experience if goods are a width other than 54".

COM Calculation Example

Below is a hypothetical scenario for how total COM yardage should be determined. This example is for a patterned textile that has a repeat.

STEP 1: DETERMINE WHICH PRODUCTS ARE BEING ORDERED AS COM

For this example order, we'll assume we need to order: 20 units of Freelance 4-leg—backs only.

STEP 2: DETERMINE THE COM YARDAGE REQUIREMENT

Looking at the COM Yardage Requirements chart that begins on page 22, we see that the following yardage amounts are needed for each product:

Freelance 4-leg chair back = 0.94 yards.

Now we multiply 0.94 yards by the 20 chair backs and we get a total of 18.8 yards.

STEP 3: ADJUST THE YARDAGE REQUIREMENT TOTAL BASED ON REPEAT

Since the textile we've chosen is a pattern with a repeat, we should look at the COM Repeat Calculation table to determine our multiplier. For this example, let's assume our repeat is 11" and we're upholstering the fabric vertical/off-the-roll. Based on the table, the multiplier is 20%. Now, we need to take the 18.8 yards from step two and increase it by 20%. An easy way to calculate this is by multiplying 18.8 by 1.2, which gives us 22.6 yards.

STEP 4: ROUND TO GET THE FINAL AMOUNT NEEDED

To determine how much yardage is needed to complete this order, we take the amount from step three and round it to the nearest half-yard. In this case, that means the customer needs to send SitOnIt Seating 23 yards to complete this order.

COM/COL TARDAGE: TASK AND CONFERENCE

Combining upholstery is an option on all SitOnIt Seating upholstered products. Below are tables outlining the fabric or vinyl requirements for the entire chair as well as individual pieces. All yardage requirements are quoted in terms of yards for fabric or vinyl and square feet for leather. Please contact Customer Experience for order quantities greater than 10 seats.

	Fabric or Vinyl (In Yardage)			Leather (In Square Feet)		
	Seat and Back	Seat Only	Back Only	Seat and Back	Seat Only	Back Only
Amplify						
Midback Mesh	—	1	—	—	17	—
Highback Mesh	—	1	—	—	17	—
Highback Mesh Large and Tall	—	1.15	—	—	18	—
Highback Upholstered	1.25	1	0.9	23	17	15
Highback Upholstered Large and Tall	1.25	1.15	—	20	18	—
Midback Mesh Task Stool	—	1	—	—	17	—
Highback Upholstered Task Stool	1.25	1	0.9	23	17	15

Anytime						
Light Task and Task Stool	1	0.8	0.75	15	10	8

Focus						
Midback Mesh	—	1	—	—	17	—
Highback Mesh	—	1	—	—	17	—
Midback Upholstered	1.15	1	0.75	23	17	15
Highback Upholstered	1.25	1	0.9	25	17	15
Highback Upholstered Large and Tall	1.25	1.15	—	31	25	—
Midback and Highback Mesh Task Stool	—	1	—	—	17	—
Midback and Highback Upholstered Task Stool	1.15	1	0.75	23	17	15

Focus 2.0						
High Back Mesh	—	1	—	—	14	—

COM/COL YARDAGE: TASK AND CONFERENCE

	Fabric or Vinyl (In Yardage)			Leather (In Square Feet)		
	Seat and Back	Seat Only	Back Only	Seat and Back	Seat Only	Back Only
Glove						
Active Midback	2.4	1.16	1.18	50	20	25
Active Midback Ballistic Nylon	1.25	1.1	1.15	36	20	20
Active Highback	2.5	1.22	1.28	55	22	32
Active Highback Ballistic Nylon	1.4	1.15	1.2	42	21	22
Executive Midback	3.25	—	—	56	—	—
Executive Midback Ballistic Nylon	2.15	—	—	44	—	—
Executive Highback	3.5	—	—	70	—	—
Executive Highback Ballistic Nylon	2.35	—	—	57	—	—
Inflex						
Light Task and Task Stool	1	0.85	0.65	15	10	7
Ioniq						
Light Task	—	0.75	—	—	7	—
Knack						
Midback	1.85	1	1.1	32	21	23
Midback Ballistic Nylon	1.55	1	1	27	21	15
Midback Task Stool	1.85	1	1.1	32	21	23
Midback Task Stool Ballistic Nylon	1.55	1	1	27	21	15
Lumin						
Light Task and Task Stool	1	0.85	0.65	15	10	7
Mavic						
Midback Mesh	—	0.8	—	—	14	—
Movi						
Light Task and Task Stool	—	0.75	—	—	10	—

COM/COL YARDAGE: TASK AND CONFERENCE

Fabric or Vinyl (In Yardage)

Leather (In Square Feet)

	Seat and Back	Seat Only	Back Only	Seat and Back	Seat Only	Back Only
--	---------------	-----------	-----------	---------------	-----------	-----------

Non-Stop Heavy Duty

Size 1 Stool	1.75	1	1	30	18	20
Size 1 Stool Ballistic Nylon	1.3	1	1	22	18	12
Size 3	2.5	1	1.75	44	17	29
Size 3 Ballistic Nylon	2	1	1.25	35	17	20

Novo

Midback and Highback Mesh	—	1	—	—	17	—
Highback Mesh Large and Tall	—	1.15	—	—	18	—
Midback and Highback Mesh Stool	—	1	—	—	17	—

OnCall

Light Task and Task Stool	0.85	0.8	0.6	14	10	8
---------------------------	------	-----	-----	----	----	---

Prava

Midback	2	0.75	1.5	35	17	28
Highback	2.25	0.75	1.75	40	17	30

ReAlign

Midback	2	1	1.6	34	17	28
Midback Ballistic Nylon	1.7	1	1.25	30	17	21
Highback	2.2	1	1.65	40	17	25
Highback Ballistic Nylon	1.75	1	1.35	32	17	25
Midback Task Stool	2	1	1.6	34	17	28
Midback Task Stool Ballistic Nylon	1.7	1	1.25	30	17	21
Highback Task Stool	2.2	1	1.65	40	17	25
Highback Task Stool Ballistic Nylon	1.75	1	1.35	32	17	25

Relay

Light Task and Task Stool	1	0.75	0.6	15	12	10
---------------------------	---	------	-----	----	----	----

COM/COL YARDAGE: TASK AND CONFERENCE

	Fabric or Vinyl (In Yardage)			Leather (In Square Feet)		
	Seat and Back	Seat Only	Back Only	Seat and Back	Seat Only	Back Only
Rio						
Light Task and Task Stool	1	0.85	0.65	15	10	7
Sona						
Midback Knit	—	1	—	—	17	—
Midback Upholstered	1.75	1	1.25	32	17	21
Torsa						
Highback Mesh	—	1	—	—	17	—
TR2						
Midback	1.5	1	0.9	25	18	18
Midback Ballistic Nylon	1.25	1	0.9	20	18	10
Executive	2	1.25	1.1	36	20	20
Executive Ballistic Nylon	1.7	1.25	1	30	20	15
Midback Task Stool	1.5	1	0.9	25	18	18
Midback Task Stool Ballistic Nylon	1.25	1	0.9	20	18	10
Vectra						
Highback Mesh	—	1.1	—	—	20	—
Wit						
Midback/Highback	N/A	1	N/A	N/A	17	N/A
Midback/Highback Task Stool	N/A	1	N/A	N/A	17	N/A

COM/COL YARDAGE: MULTIPURPOSE AND SIDE

Combining upholstery is an option on all SitOnIt Seating upholstered products. Below are tables outlining the fabric or vinyl requirements for the entire chair as well as individual pieces. All yardage requirements are quoted in terms of yards for fabric or vinyl and square feet for leather. Please contact Customer Experience for order quantities greater than 10 seats.

	Fabric or Vinyl (In Yardage)			Leather (In Square Feet)		
	Seat and Back	Seat Only	Back Only	Seat and Back	Seat Only	Back Only
Achieve						
Plastic Back	–	1	–	–	17	–
Upholstered Back	1.75	1	1	30	17	15
Anytime						
Multipurpose	1	0.8	0.75	15	10	8
Bar Stool	1	0.8	0.75	15	10	8
Baja						
Multipurpose	1	0.75	–	–	–	–
Bar Stool (Standard Back)	1	0.75	–	–	–	–
Bar Stool (Low Back)	0.75	0.75	–	–	–	–
Focus Side						
Multipurpose Mesh/Wood	–	1	–	–	17	–
Multipurpose Upholstered	1.25	1	0.75	20	12	10
Counter and Bar Stool Mesh/Wood	–	1	–	–	17	–
Counter and Bar Stool Upholstered	1.25	1	0.75	20	12	10
Freelance						
Multipurpose/Sled	1.25	0.99	1	25	15	–
Multipurpose/Sled Ballistic Nylon	1.15	0.99	0.9	21	15	–
Bariatric (30")	2.25	1	1.35	40	20	–
Bariatric (30") Ballistic Nylon	1.67	1	1	30	20	–
Bariatric (42")	2.5	1.25	1.5	42	25	–
Bariatric (42") Ballistic Nylon	1.75	1.25	1.25	40	25	–
Counter and Bar Stool	1.25	0.99	1	25	15	–
Counter and Bar Stool Ballistic Nylon	1.15	0.9	1	21	15	–

COM/COL YARDAGE: MULTIPURPOSE AND SIDE

	Fabric or Vinyl (In Yardage)			Leather (In Square Feet)		
	Seat and Back	Seat Only	Back Only	Seat and Back	Seat Only	Back Only
Inflex						
Multipurpose	1	0.85	0.65	15	10	7
Counter and Bar Stool	1	0.85	0.65	15	10	7
Ioniq						
Multipurpose Chair	—	0.75	—	—	7	—
Guest Chair	—	0.75	—	—	7	—
Lumin						
Multipurpose	1	0.85	0.65	15	10	7
Wire Rod	1	0.85	0.65	15	10	7
Counter and Bar Stool	1	0.85	0.65	15	10	7
Mika						
4-Leg	—	0.85	—	—	—	—
Wire Rod	—	0.85	—	—	—	—
Movi						
Nester	—	0.75	—	—	10	—
OnCall						
Multipurpose	0.85	0.8	0.6	14	10	8
Bar Stool	0.85	0.8	0.6	14	10	8
Qwiz						
Nester	1	0.75	—	—	—	—
Relay						
Multipurpose	1	0.75	0.6	15	12	10
Nester	1	0.75	0.6	15	12	10

COM/COL YARDAGE: MULTIPURPOSE AND SIDE

Fabric or Vinyl (In Yardage)

Leather (In Square Feet)

	Seat and Back	Seat Only	Back Only	Seat and Back	Seat Only	Back Only
Rio						
Multipurpose	1	0.85	0.65	15	10	7
Wire Rod	1	0.85	0.65	15	10	7
Counter and Bar Stool	1	0.85	0.65	15	10	7

Rowdy

Wire Rod	–	0.75	–	–	13	–
----------	---	------	---	---	----	---

Wit Side

Multipurpose	–	0.75	–	–	10	–
--------------	---	------	---	---	----	---

COM/COL YARDAGE: LOUNGE

Combining upholstery is an option on all SitOnIt Seating upholstered products. Below are tables outlining the fabric or vinyl requirements for the entire chair as well as individual pieces. All yardage requirements are quoted in terms of yards for fabric or vinyl and feet for leather. Please contact Customer Experience for order quantities greater than 10 seats.

	Fabric or Vinyl (In Yardage)			Leather (In Square Feet)		
	Fully Upholstered	Seat Only	Back Only	Fully Upholstered	Seat Only	Back Only
Aviera						
Guest 21"	1.9	1.2	1.1	—	—	29.4
Guest 24"	1.9	1.2	1.6	—	—	43.4
Guest 30"	3.1	1.2	1.9	—	—	47.6
Guest 44"	3.4	1.6	1.9	—	—	50.4
Hip Chair	1.9	1.2	1.1	—	—	29.4
Patient 21"	2.8	1.2	1.9	—	—	35
Patient 24"	2.8	1.2	2.2	—	—	43.4
Patient 30"	3.8	1.2	2.5	—	—	50
Freespan 2-Seat 21"	3.8	1.9	2.1	—	—	58
Freespan 2-Seat 24"	4.3	2.2	3.1	—	—	86
Freespan 3-Seat 21"	5.6	3	3.1	—	—	88.2
Freespan 3-Seat 24"	5.9	3	4.7	—	—	93
Pre-Configured 2-Seat 21"	3.8	1.9	2.1	—	—	58
Pre-Configured 2-Seat 24"	4.3	2.2	3.1	—	—	86
Pre-Configured 3-Seat 21"	5.6	3	3.1	—	—	88.2
Pre-Configured 3-Seat 24"	5.9	3	4.7	—	—	93
Start/Center/End 21"	2.8	1.2	1.9	—	—	35
Start/Center/End 24"	2.8	1.2	2.2	—	—	43.4
Start/Center/End 30"	3.8	1.2	2.5	—	—	47.6
Start/Center/End 44"	3.4	1.6	1.9	—	—	50.4

COM/COL YARDAGE: LOUNGE

	Fabric or Vinyl (In Yardage)			Leather (In Square Feet)		
	Fully Upholstered	Seat Only	Back Only	Fully Upholstered	Seat Only	Back Only
Cameo						
Single Seat, Dual Arms	5	1.75	1.6	2.25	—	99
Single Seat, Right or Left Arm	4	1.75	1.6	1.25	—	78
Single Seat, Armless	3.25	1.75	1.6	—	—	63
Single Seat, Bench	2	2	—	—	—	36
2-Seater, Dual Arms	7.5	3.25	3	2.25	—	147
2-Seater, Right or Left Arm	6.5	3.25	3	1.25	—	126
2-Seater, Armless	5.75	3.25	3	—	—	115
2-Seater, Bench	3.75	3.75	—	—	—	68
3-Seater, Dual Arms	10.5	5	4.75	2.25	—	170
3-Seater, Right or Left Arm	9	5	4.75	1.25	—	150
3-Seater, Armless	8	5	4.75	—	—	130
3-Seater, Bench	5	5	—	—	—	84

Composium						
Club Chair	5.3	1.9	2.2	3.8	1	83.3
Settee	7.9	3.2	4.1	3.8	1.3	122.5
Sofa	10.5	3.8	5.8	3.8	1.3	163.7
Ottoman	3.2	1.9	—	—	1.9	49
Bench, Single Seat	3.2	1.9	—	—	1.9	49
Bench, Double Seat	3.8	2.9	—	—	2.9	58.8
Bench, Triple Seat	4.4	2.9	—	—	2.9	68.6

Envoi						
Midback Club Chair	3	1	2.5	—	—	50
Highback Club Chair	3.25	1	2.75	—	—	55

Envoi back yardage includes yardage for arms.

Gobi						
Club Chair	3.5	2.8	1	—	—	55

Gobi back yardage includes yardage for arms.

COM/COL YARDAGE: LOUNGE

Fabric or Vinyl (In Yardage)

Leather (In Square Feet)

	Fully Upholstered	Seat Only	Back Only	Fully Upholstered	Seat Only	Back Only
Nano						
Triangle	2	1	—	—	2	—
Diamond	3	1.5	—	—	2	—
Trapezoid	3.5	1.5	—	—	3	—
Boomerang	6.5	3	—	—	4	—

Paréa

Seat, Single	3	2	1.56	—		
Seat, 1½	4	2.5	1.75	—		
Seat, 90-Degree	5.25	2.75	3	—		
Seat, 120-Degree Inner or Outer	4.38	2.75	2.5	—		
Bench, Single	2	2	—	—		
Bench, 1½	2.5	2.5	—	—		
Bench, Right-Angled or Left-Angled	2.5	2.5	—	—		
Bench, 90° Corner	2.5	2.5	—	—		
Bench, 120° Bench	2.5	2.5	—	—		
Ottoman, Mini Round	1.75	1	—	—		
Ottoman, Mini Square	1.88	1	—	—		
Ottoman, Mini With Table Top	1.25	—	—	—		
Ottoman, Large Round	3.35	1.56	—	—		
Ottoman, Large Square	3.44	1.56	—	—		
Ottoman, Large With Table Top	2	—	—	—		

Visit Modular

Ottoman	1.88	1.88	—	—	0.94	29.4
Club Chair, Armless	3.5	1.9	2.2	—	—	54.5
Club Chair, Upholstered Left or Right Arm	4.4	1.9	2.2	1.88	—	83.3
Club Chair, Upholstered Left and Right Arms	5.4	1.9	2.2	2.9	—	83.3
Club Chair, Wood Left or Right Arm	3.5	1.9	2.2	—	—	54.5
Club Chair, Wood Left and Right Arms	3.5	1.9	2.2	—	—	54.5

Pricing

First-time custom stains must be approved before acceptance of an order. A one-time net fee applies if stains are not in our library. Thereafter, a stain-to-match upcharge is applied to each chair.

TASK AND SIDE CHAIRS

Stain not in our library: \$350 Net

Stain-to-match upcharge: \$55 List

LOUNGE

Stain not in our library: \$275 Net

Stain-to-match upcharge: \$70 List

Ordering

When ordering, enter the approved STAIN ID# in the Material section of the Final Price Calculation worksheet or on your purchase order.

Custom Finish Terms and Conditions

Wood is inherently beautiful because of natural variations in color, grain and texture. There may be minor differences from one chair to the next, even though they are finished at the same time. We cannot guarantee exact matches of grain or natural wood color.

Approval Process

Since all new stains must be approved before they can be applied to seating or tables, allow extra time for custom finishes. Custom finishes generally require at least one to two weeks to create a matched sample. We will need a signed Approval Form before we can accept your order. We reserve the right to decline the opportunity to match a finish color.

1. Send a 3" x 4" or 4" x 6" sample of the stain, along with the model numbers and options to which the finish will be applied, to:

Customer Experience
Custom Finish Program
6415 Katella Avenue
Cypress, CA 90630

Include dealer name, contact and project reference.

2. Once approved, we will send a finish sample to you along with any caveats that may apply. We will keep an identical sample in our files for future orders. Custom finishes generally require at least a week to create a matched sample.
3. Carefully review the sample. Note the STAIN ID# (example: SM#070214-1); this will be needed for your order. Return the signed approval form to Customer Experience along with your order. We need your approval before we can accept the order, schedule it for production or acknowledge a ship date.
4. Lounge orders using our stain-to-match program will have a lead time of 15 days.

Safety First

To ensure proper cleaning and/or disinfecting, it's important to consult with facilities or safety personnel and follow the manufacturer's instructions—including detailed dilution requirements, safe application instructions, dwell time for effective disinfecting and more.

Per CDC instructions, always read and follow the directions on the label to ensure safe and effective use.

- Wear skin protection and consider eye protection for potential splash hazards
- Ensure adequate ventilation
- Use no more than the amount recommended on the label
- Use water at room temperature for dilution (unless stated otherwise on the label)
- Avoid mixing chemical products
- Label diluted cleaning solutions
- Store and use chemicals out of the reach of children and pets

Always read and follow the directions on the cleaner/disinfectant labels to ensure safe and effective use.

Clean + Disinfect

Cleaning and disinfecting are two distinct actions, and knowing the difference between the two can help promote safety in any space. This comprehensive, 2-step process requires cleaning before disinfecting.

Clean

CLEANING REMOVES GERMS

- The act of removing visible dirt and debris from objects or surfaces
- Cleaning works by using soap/detergent with water to remove impurities from surfaces either manually or mechanically
- Cleaning does not kill germs, but by removing them, it lowers their numbers and risk of spreading infection

Clean (Cont.)

CLEANING GUIDELINES AND TIPS

- Start by lightly dusting with a soft, grit-free cloth or chamois (no wiping)
- After dusting, dampen cloth or chamois with a solution of mild, non-abrasive liquid soap and water
- Wipe clean and dry with a soft, grit-free cloth, sponge or chamois
- Avoid using abrasive cleaners and steel wool to prevent scratching
- Test any cleaning method or agent in an inconspicuous area of the surface

Disinfect

DISINFECTING KILLS GERMS

- This process comes after a surface is cleaned
- Disinfecting kills germs on objects or surfaces with the use of chemicals
- Most common disinfectants include one of the following active ingredients: Quaternary Ammonium (Quats), Sodium Hypochlorite (Bleach), Hydrogen Peroxide, or 70% Isopropyl Alcohol
- EPA-registered disinfectants List N: Disinfectants for Use Against SARS-CoV-2

DISINFECTING GUIDELINES AND TIPS

- Follow the disinfectant manufacturer's instructions when applying the agent
- Once finished, remove all disinfecting agents from the surface with water and a grit-free cloth, then dry
- If not properly removed, disinfectant residue could degrade product life and appearance

Cleaning + Disinfecting efforts should be part of an organization's comprehensive systems-based approach to provide a safe and sustainable workspace.

Cleaning Our Hard Surfaces

Over 95% of the hard surfaces on our products can be cleaned/disinfected using any one of the four primary ingredients listed below.

- Bleach (Sodium Hypochlorite)
- Hydrogen Peroxide
- Quaternary Ammonium Compounds (Quats)
- 70% Isopropyl Alcohol

EXAMPLES OF HARD SURFACES THAT CAN BE DISINFECTED:

- Plastics (i.e. polyurethane and acrylic)
- Solid Surface
- Metals
- Painted Surfaces
- Laminate

EXCEPTIONS:

- Markerboard
- Veneer
- Wood Surfaces

Clean + Disinfect

Cleaning and disinfecting are two distinct actions, and knowing the difference between the two can help promote safety in any space. This comprehensive, 2-step process requires cleaning before disinfecting.

Cleaning Our Soft Surfaces

Our textiles and meshes offer a performance and cleaning story unmatched in the industry.

Our Carded Textile Program offers over 700 bleach-cleanable fabrics through our SitOnIt Seating private label and partnership textile program.

MESH:

- All of our mesh materials are bleach-cleanable. This determination is supported by 3rd-party results from completing AATCC 188 Colorfastness to Bleach testing where the subject material is submerged, and friction stirred in a diluted sodium hypochlorite solution.
- Cleaning of our mesh materials varies. Check out the [Mesh Spec + Care Guide](#) on our website for more information.

SEATING FABRICS:

- Soft surfaces on seating can vary widely from woven, knits and leather to coated textiles such as vinyl and polyurethane. Woven and knits tend to be more permeable than vinyl or polyurethane.
- Cleaning of our seating fabric materials varies. For a list of our textile spec + care guides, see the [Materials Downloads](#) on our website.
- For a list of bleach-cleanable materials, see our [Carded Library](#) and select "Bleach Cleanable" under performance.

SCREEN FABRICS:

- Cleaning of screen materials varies. For a list of our textile spec + care guides, see the [Materials Downloads](#) on our website.
- For a list of bleach-cleanable materials, see our [Carded Library](#) and select "Bleach Cleanable" under performance.

GLIDE GUIDE

For almost 25 years, SitOnIt Seating products have been expertly designed to provide the best comfort and support in the industry.

Glides are an often overlooked element in the seating specification process, but they play a crucial role in ensuring proper interface between the chair and the floor.

This application guide offers general guidelines to assist customers with choosing the best glide for their needs. The guide is based on extensive lab testing and hands-on experience with selling chairs in a variety of environments, as well as review and consultations with glide experts.

Application Guide

Material		Surfaces						
Glide Type (4-Leg)		Carpet	VCT	Vinyl	Laminate	Ceramic Tile	Hardwood	Concrete
Standard Multi-Surface Glides	Applies to Anytime, Baja, Freelance, Focus Side, InFlex, Lumin, Rio and Wit Side	Acceptable	Acceptable	Acceptable	Better	Better	NR	Better
Performance Multi-Surface Glides		Best	Better	Better	Better	Best	Better	Better
Floor Saver Glides		NR	Best	Best	Best	NR	Best	Best
Steel Glides (Carpet Only)		Better	NR	NR	NR	NR	NR	NR

Material		Surfaces						
Glide Type (Wire Rod)		Carpet	VCT	Vinyl	Laminate	Ceramic Tile	Hardwood	Concrete
No Glides	Applies to Baja, Lumin, Mika, OnCall, Rio and Rowdy	Best	NR	NR	NR	NR	NR	NR
Clear Glides		NR	NR	Acceptable	Better	Better	NR	Acceptable
Clear Glides With Felt		NR	Better	Better	Best	NR	Better	NR

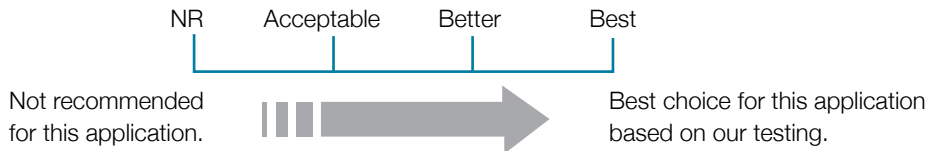

- **BEST:** Best choice for this application based on our testing.
- **BETTER:** Better choice for this application based on our testing.
- **ACCEPTABLE:** Acceptable choice for this application based on our testing but consider BETTER or BEST options.
- **NR:** Not recommended for this application based on our testing.

This Application Guide is provided for informational purposes only. Always follow the manufacturer's instructions for care and maintenance of your flooring. Periodic inspection and maintenance of glides is critical to minimize the risk of damage to your flooring, especially when using glides with floors that are prone to scratching and marring. Testing was performed under simulated conditions. Because a wide range of factors impact actual performance, including how your chairs are used; the state of the glides and flooring; and dirt, moisture and other environmental factors, Exemplis does not warrant you will achieve any specific result. Actual results may vary.

STACKING GUIDE

Discover stacking compatibility with Sitonit Seating's multipurpose products—including a list of SitOnIt models with a wall-saver frame.

4-Leg

Collection	Plastic Seat and Back	Upholstered Seat With Plastic Back	Upholstered Seat and Back	Wall-Saver Frame
On Cart				
Achieve (Glides Only)	—	5	5	•
Anytime (Glides Only)	8	8	8	
Baja (Glides Only)	10	8	8	
Freelance (Glides Only)	6	6	6	•
InFlex (Glides Only)	12	Arms NR, 10 Armless	Arms NR, 10 Armless	
Lumin (Glides Only)	8	6	6	
Mika (Glides Only)	12	12	—	
Relay (Glides Only)	5	5	5	•
Rio (Glides Only)	8	7	7	
On Floor				
Achieve (Casters and Glides)	—	4	4	•
Anytime (Glides Only)	6	6	6	
Baja (Casters and Glides)	6	4	4	
Freelance (Casters and Glides)	4	4	4	•
InFlex (Casters and Glides)	5	Arms NR, 5 Armless	Arms NR, 5 Armless	
Lumin (Casters and Glides)	6	4	4	
Mika (Casters and Glides)	3	9	—	
Relay (Glides Only)	5	5	5	•
Rio (Casters and Glides)	4	3	3	

Freelance sled base and bariatric models are not stackable. Relay nester stacks three on the floor: vertical. Ioniq and Qwiz do not stack.

4-Leg Mesh

Collection	Plastic Seat Mesh Back	Upholstered Seat With Mesh Back	Fully Upholstered Seat and Back	Wall-Saver Frame
On Cart				
Focus Side (Glides Only)	—	5	3	•
Wit Side (Glides Only)	4	4	4	•
On Floor				
Focus Side (Glides or Casters)	—	4	3	•
Wit Side (Glides or Casters)	4	NR	NR	•

Focus Side wood back models are not stackable.

Please note that chairs with a tablet arm do not stack. Chairs with casters do not stack on a cart.

Please use caution when stacking models with casters to prevent frame damage. SitOnIt Seating does not warrant scratched frames.

NR — Not recommended.

STACKING GUIDE

Wire Rod

Collection	Plastic Seat and Back	Upholstered Seat With Plastic Back	Upholstered Seat and Back	Wall-Saver Frame
On Cart				
Baja (Glides Only)	6	4	4	
Lumin (Glides Only)	15	6	6	
Mika	30	12	—	
OnCall (Glides Only)	20 With Arms, 25 Armless	NR	NR	•
Rio (Glides Only)	15	6	6	
Rowdy (Glides Only)	25 With Arms, 40 Armless	NR	NR	
On Floor				
Baja	6	6	6	
Lumin	8	4	4	
Mika	3	6	—	
OnCall	8	NR	NR	•
Rio	6	5	5	
Rowdy	10 With Arms, 15 Armless	NR	NR	

Stool

Collection	Plastic Seat and Back	Upholstered Seat With Plastic Back	Upholstered Seat and Back	Wall-Saver Frame
On Floor				
Baja	4	4	4	
Mika	3	3	—	
OnCall	4	NR	NR	•

Please note that chairs with a tablet arm do not stack. Chairs with casters do not stack on a cart.

Please use caution when stacking models with casters to prevent frame damage. SitOnIt Seating does not warrant scratched frames.

NR — Not recommended.

HEAVY DUTY SERIES

Heavy Duty Guide

SitOnIt Seating Heavy Duty Series offers an unmatched combination of strength, comfort and ergonomic support to accommodate various users, all at a value-driven price point, in addition to standard two-, five- and 10-day lead times.

The models in the Heavy Duty series include heavy duty task and side models that are rated up to a 350 lb, 400 lb, 500 lb or 1,000 lb capacity. These models feature expert construction that allow for 24-hour multi-shift usage.

LIMITED 10-YEAR WARRANTY

SitOnIt Seating warrants the Heavy Duty Series for a period of 10 years when configured to the appropriate model. Fabric and foam cushioning are covered for two years.

TEXTILE DURABILITY

SitOnIt Seating recommends textiles that are high-density and abrasion-resistant, with at least a 75,000 double rub rating.



Task

	Standard	Heavy Duty	Large and Tall	Extra Large
Weight Capacity	Rated Up to 300 lb	Rated Up to 350 lb	Rated Up to 400 lb	Rated Up to 500 lb
Models	Amplify, Focus, Knack, Novo, Prava, ReAlign, Sona, Torsa, TR2, Wit	Task Chairs: Focus, Glove Active, Knack, ReAlign, TR2 Task Stools: Non-Stop Heavy Duty Stool, TR2	Novo, Amplify, Focus	Non-Stop
Seat Width	Standard	Standard	22"	23"
Back Width	Standard	Standard	Standard	22"
Warranty	Lifetime / Single-Shift 12-Year / Multi-Shift for Amplify, Novo, Torsa, Wit	10-Year / Multi-Shift	10-Year / Multi-Shift	10-Year / Multi-Shift
List Price (Upcharge From Base Model)	+ \$0	+ \$126 All Task Models + \$191 TR2 Stool	+ \$250 Focus, Amplify + \$295 Novo	+ \$470



Side

	Heavy Duty	Bariatric – 30"	Bariatric – 42"
Weight Capacity	Rated Up to 350 lb	Rated Up to 500 lb	Rated Up to 1000 lb
Models	Freelance	Freelance Bariatric	Freelance Bariatric
Seat Width	19.5"	30"	42"
Back Width	19.5"	30"	42"
Warranty	10-Year / Multi-Shift	10-Year / Multi-Shift	10-Year / Multi-Shift
List Price (Upcharge From Base Model)	+ \$306	+ \$0	+ \$417

HEAVY DUTY SERIES

Large and Tall

SitOnIt Seating Large and Tall (LT) models are available as a standard to provide a fully coordinated and cohesive family offering on our Amplify, Focus and Novo task chairs. Large and Tall accommodates users up to 400 lb and SitOnIt Seating warrants for a period of 10 years used in multi-shift (24/7) applications.

Specify Large and Tall models by using the LT suffix when ordering. Add the appropriate additional charge for each chair. The list below summarizes the model, arm styles, mechanism, frame, back and base options.



Large and Tall (LT) Models

Large and Tall Options (List Price)	Amplify 2723 B1 Y A152 LT	Focus 5623 B1 Y A152 LT	Novo 1033 BK2 Y A152 LT
LT Base Model: Highback, Black Frame, Enhanced Synchro, Height-Adjustable With Sport Arm Pads	\$897	\$943	\$870
1. Arm Styles			
Height-Adjustable With Sport Arm Pads (A152)	+ \$0	+ \$0	+ \$0
Armless (A0)	- \$48	- \$90	- \$48
Height-/Width-Adjustable With Sport Arm Pads (A153)	+ \$30	+ \$25	+\$30
2. Seat Depth			
Seat Depth Adjustment (E3)	+ \$79	+ \$79	+ \$79
3. Frame			
Back Support Color	Black (FC1)	Black (Z1) or Silver (Z2)	Black (FC1)
4. Back			
Upholstered Back (B3)	+ \$49	N/A	N/A
Upholstered Pad (B4)	N/A	+ \$126	N/A
Adjustable Lumbar (LB1)	+ \$0	+ \$50	+ \$0
5. Base			
Polished Aluminum Base (B5)	+ \$167	+ \$167	+ \$167
Heavy Duty Hard Floor and Carpet Casters (C9)	+ \$61	+ \$61	+ \$61
High Heavy Duty Cylinder (S13)	+ \$0	+ \$0	+ \$0

Chairs and Stools

TASK | LIGHT TASK | EXECUTIVE
CONFERENCE | COLLABORATIVE

Statement of Line

TASK | LIGHT TASK | EXECUTIVE CONFERENCE | COLLABORATIVE



Amplify Mesh
Midback Task Chair
2722 B1 44



Amplify Mesh
Highback Task Chair
2723 B1 44



Amplify Mesh
Midback Task Stool
2723 B3 S1/S2 48

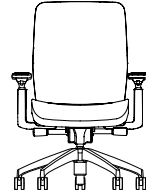

Amplify Upholstered
Highback Task Chair
2722 B1 52

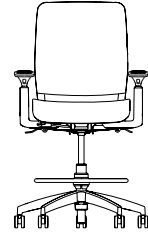

Amplify Upholstered
Highback Task Stool
2723 B3 S1/S2 56



Anytime
Light Task Chair
93T 59



Anytime
Light Task Stool
93T S1 59

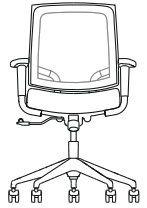

Focus Mesh
Midback Task Chair
5622 B1 62

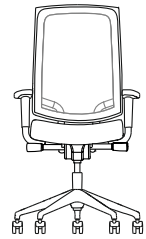

Focus Mesh
Highback Task Chair
5623 B1 62

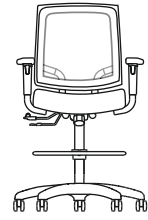

Focus Mesh
Midback Stool
5622 B1 S1/S2 67

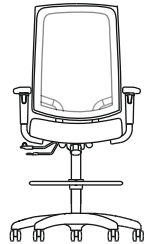

Focus Mesh
Highback Stool
5623 B1 S1/S2 67

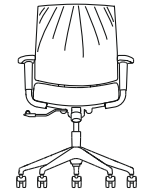

Focus Upholstered
Midback Task Chair
5622 B4 71

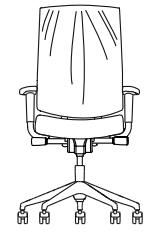

Focus Upholstered
Highback Task Chair
5623 B4 71

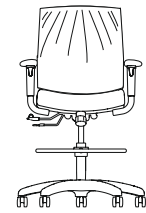

Focus Upholstered
Midback Task Stool
5622 B4 S1/S2 76

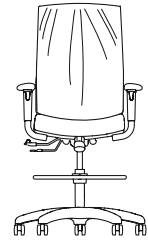

Focus Upholstered
Highback Task Stool
5623 B4 S1/S2 76

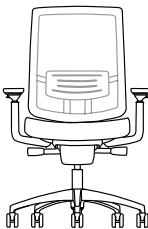

Focus 2.0
Meshback Task Chair
1123 BK2 MB 80

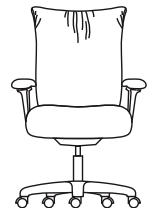

Glove Active
Midback Conference Chair
7531 84

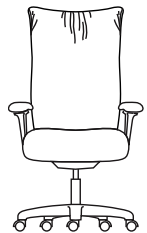

Glove Active
Highback Conference Chair
7532 84

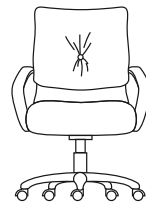

Glove Executive
Midback Conference Chair
7541 88

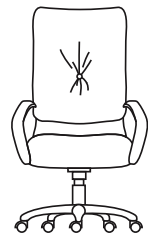

Glove Executive
Highback Executive Chair
7542 88

Statement of Line

TASK | LIGHT TASK | EXECUTIVE CONFERENCE | COLLABORATIVE



InFlex
Light Task Chair
973..... 91



InFlex
Light Task Stool
973B S1/S2 91

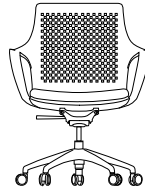

Ioniq
Collaborative Chair
1152 FT3..... 95



Knack
Midback Task Chair
3323..... 98



Knack
Midback Task Stool
3323 S1/S2..... 102

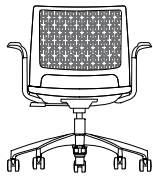

Lumin
Light Task Chair
1012 FT3..... 105

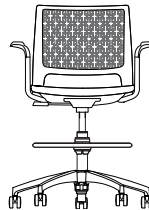

Lumin
Light Task Stool
1012 FT3 S21/S22..... 105



Mavic
Collaborative Chair
1113 109

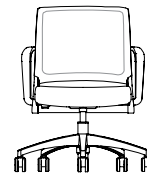

Movi
Light Task Chair
1062 FT3..... 112



Movi
Light Task Stool
1062 FT3 S21/S22..... 112

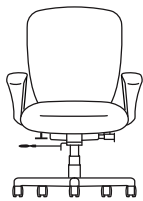

Non-Stop
Heavy Duty Task Chair
673..... 115



Non-Stop
Heavy Duty Task Stool
671 B2 118



Novo
Midback Mesh Task Chair
1033 BK1 121

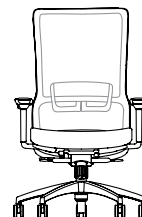

Novo
Highback Mesh Task Chair
1033 BK2..... 121

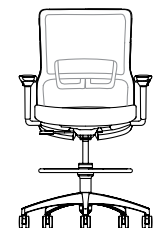

Novo
Midback Mesh Task Stool
1033 BK1 S1..... 126

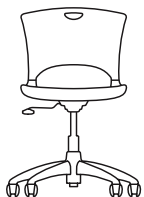

OnCall
Light Task Chair
90T..... 130

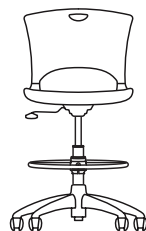

OnCall
Light Task Stool
90TB S1/S2 130

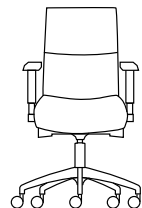

Prava
Midback Conference Chair
6422..... 134

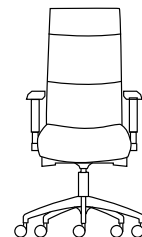

Prava
Highback Conference Chair
6423..... 134

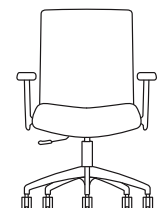

ReAlign
Midback Task Chair
681..... 138

Statement of Line

TASK | LIGHT TASK | EXECUTIVE CONFERENCE | COLLABORATIVE

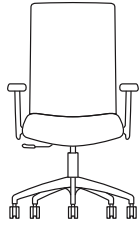

ReAlign
Highback Task Chair
682 138

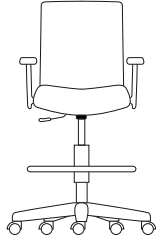

ReAlign
Midback Task Stool
681B 142

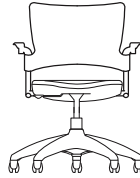

Relay
Light Task Chair
94T 145

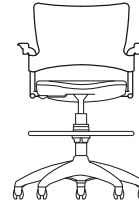

Relay
Light Task Stool
94B S1/S2 145

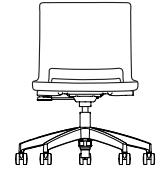

Rio
Light Task Chair
1052 FT3 149

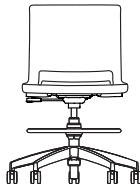

Rio
Light Task Chair
1052 FT3 S21/S22 149

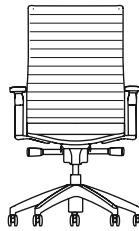

Sona
Knit Back Conference Chair
5723 B7 153

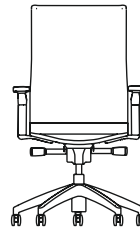

Sona
Upholstered Conference Chair
5723 B8 153

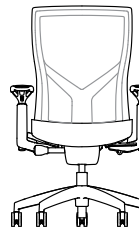

Torsa
Mesh Back Conference Chair
5723 B8 157



TR2
Midback Task Chair
40 161



TR2
Highback Executive Chair
40E 161



TR2
Midback Task Stool
40 S1/S2 165

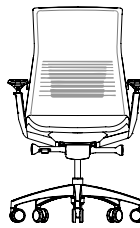

Vectra
Highback Mesh Task Chair
1073 BK2 MB 165

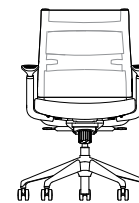

Wit Mesh
Midback Task Chair
2222 B1 173

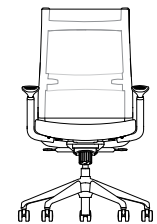

Wit Mesh
Highback Task Chair
2223 B1 173



Wit Mesh
Midback Task Stool
2222 B1 S1/S2 177

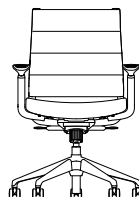

Wit Thintex
Midback Task Chair
2222 B9 181

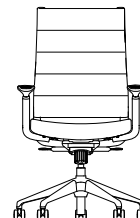

Wit Thintex
Highback Task Chair
2223 B9 181



Wit Thintex
Midback Task Stool
2222 B9 S1/S2 185

Amplify

MESH BACK TASK CHAIR

The power of more.

The sleek, aerodynamic design gives Amplify™ power with the appearance of smart, no-nonsense efficiency and comfort. The supportive mesh back with adjustable lumbar support, three application-specific arm types and waterfall seat add great ergonomics and comfort to the equation. The eye-catching lumbar bands, curvaceous profile and soft, textured arm pads make this a chair that delivers style as well as substance.



Featured Models

GOOD :: \$559

Midback, black frame, swivel-tilt mechanism, fixed arms, black nylon base, carpet casters, grade 1 textile

BETTER :: \$647

Highback, black frame, enhanced synchro mechanism, height-adjustable arms, black nylon base, carpet casters, grade 1 textile

BEST :: \$791

Highback, fog frame, enhanced synchro mechanism with seat-depth adjustment, multi-adjustable arms, fog nylon base, carpet casters, grade 1 textile

Features

- Midback or highback task chair
- Aerodynamic design
- Multiple frame, back support and arm color choices
- Adjustable lumbar support
- 10 bleach-cleanable mesh back colors
- Contrast stitching in 10 thread colors
- Enhanced synchro or swivel-tilt
- Waterfall seat
- Three arm styles with textured arm pads
- Black, fog or polished aluminum base
- Optional seat-depth adjustment
- Standard 300 lb weight capacity warranty;
Heavy Duty Series 400 lb weight capacity warranty

1. Back

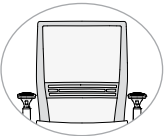
Back Size and Style	Code	Price	
Midback Mesh With Adjustable Lumbar Support	2722 B1	\$619	
Highback Mesh With Adjustable Lumbar Support	2723 B1	\$647	

2. Heavy Duty

Heavy Duty Series	Code	Price	
Large and Tall (Black Highback Frame With Enhanced Synchro Y Mechanism and Sport Height-Adjustable Arms)	LT	+ \$250	

See the Heavy Duty Guide on page 38 for additional LT and HD options.

MESH BACK TASK CHAIR

3. Mechanism

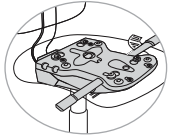
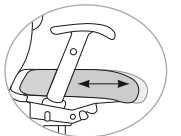
Mechanism Style	Code	Price	
Swivel-Tilt	T	-\$50	
Enhanced Synchro	Y	+\$0	
Seat-Depth Adjustment	Code	Price	
Seat-Depth Adjustment	E3	+\$79	

Seat-depth adjustment (E3) not available on swivel-tilt (T) mechanism.





Better

4. Frame

Frame Color	Code	Price	
Black	FC1	+ \$0	
Fog	FC13	+ \$35	

Frame color includes base, lumbar support band and arms.

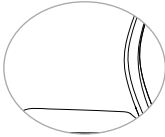
5. Arms

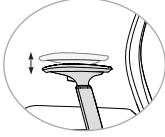
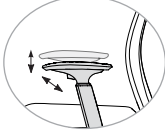
Arm Style	Code	Price	
Armless	A0	- \$48	
Fixed Polyurethane	A140	- \$10	
Height-Adjustable	A141	+ \$0	
Multi-Adjustable (Height/Width)	A142	+ \$30	

Arm color will match the frame. Arm pads are black except fixed polyurethane arm (A140) which matches frame color.

6. Base

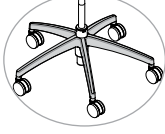
Base Color and Material	Code	Price	
Black Nylon Base (For Black Frame FC1)	B17	+ \$0	
Fog Nylon Base (For Fog Frame FC13)	B21	+ \$0	
Polished Aluminum Base	B18	+ \$113	

MESH BACK TASK CHAIR

6. Base (Cont.)

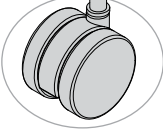
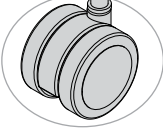
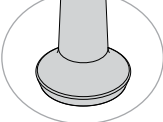
Casters or Glides	Code	Price	
Casters			
Black Carpet Casters	C16	+ \$0	
Black Hard Floor and Carpet Casters	C17	+ \$40	
Glides			
Glides for Task Chairs	C3	+ \$30	

Cylinder Height	Code	Price	
Standard Cylinder	S0	+ \$0	
Higher Cylinder	S13	+ \$0	

Nylon bases pair only with their corresponding frame color. Polished aluminum base (B18) can be used with all frame colors.

7. Material

Protection	Code	Price	
CAL 133, Fabric, Quantities 1-49	133F	+ \$99	
CAL 133, Fabric, Quantities 50+	133F5	+ \$55	
CAL 133, Leather, Any Quantity	133L	+ \$119	
Mesh Color	Code	Price	
Apple	MC31	+ \$0	
Aqua	MC30	+ \$0	
Desert	MC9	+ \$0	
Electric Blue	MC24	+ \$0	
Fire	MC10	+ \$0	
Fog	MC7	+ \$0	
Navy	MC8	+ \$0	
Nickel	MC6	+ \$0	
Onyx	MC5	+ \$0	
Tangerine	MC28	+ \$0	

7. Material (Cont.)

Seat Textile	Code	Price	
COM	COM	+ \$0	
Fabric/Vinyl Grade 1	FG1/VG1	+ \$0	
Fabric/Vinyl Grade 2	FG2/VG2	+ \$26	
Fabric/Vinyl Grade 3	FG3/VG3	+ \$60	
Fabric/Vinyl Grade 4	FG4/VG4	+ \$116	
Fabric/Vinyl Grade 5	FG5/VG5	+ \$172	
Fabric/Vinyl Grade 6	FG6/VG6	+ \$213	
Fabric/Vinyl Grade 7	FG7/VG7	+ \$254	
COL	COL	+ \$300	
Leather Grade 1	LG1	+ \$300	
Leather Grade 2	LG2	+ \$380	
Leather Grade 3	LG3	+ \$480	
Contrast Stitching	Code	Price	
No Contrast Stitching	TC0	+ \$0	
Apple Thread	TC3	+ \$0	
Desert Thread	TC9	+ \$0	
Electric Blue Thread	TC4	+ \$0	
Fire Thread	TC10	+ \$0	
Fog Thread	TC7	+ \$0	
Lemon Thread	TC2	+ \$0	
Navy Thread	TC8	+ \$0	
Nickel Thread	TC6	+ \$0	
Onyx Thread	TC5	+ \$0	
White Thread	TC1	+ \$0	

Contrast stitching available only for SitOnIt Seating carded fabrics in solid colors.

Please reference the Textile Reference Guide for pricing on fabric over grade 7 and leather over grade 3.

8. Packaging

Packaging	Code	Price	
Knocked Down	KD	+ \$0	
Back Attached to Seat, Base Separate	UC	+ \$80	
Fully Assembled in Carton	AC	+ \$200	

MESH BACK TASK CHAIR

SPECIFICATIONS

	2722 Midback Mesh Task Chair	2723 Highback Mesh Task Chair	2723 LT Large and Tall Task Chair
Overall Width Without Arms	26"	26"	26"
Overall Width With Arms	27.75"-28.25"	27.75"-28.25"	29"
Overall Depth	24.5"	24.5"	27.75"
Overall Height	40"	43"	42"
Seat Width	19.25"	19.25"	22"
Seat Depth	17.5"-19.75"	17.5"-19.75"	17.5"
Seat Height With Standard Base	16.5"-20.12" (T) 16.5"-20.35" (Y)	16.5"-20.12" (T) 16.5"-20.35" (Y)	N/A 17.5"-21.5" (Y)
Seat Height With Higher Cylinder	17.5"-21.87" (T) 18"-22.5" (Y)	18"-23" (T) 18"-22.5" (Y)	N/A 18"-22.5" (Y)
Back Width	19.5"	19.5"	19.5"
Back Height	20.37"	23.37"	22"
Weight Armless	32 lb	34 lb	44 lb
Weight With Arms	37 lb	39 lb	50 lb
COM	1 yd	1 yd	1.15 yd
COL	17 sq ft	17 sq ft	18 sq ft
Weight Capacity Warranty	300 lb	300 lb	400 lb

Swivel-tilt mechanism (T). Enhanced synchro mechanism (Y).



Good

Amplify

MESH BACK TASK STOOL

The power of more.

The sleek, aerodynamic design gives Amplify™ power with the appearance of smart, no-nonsense efficiency and comfort. The supportive mesh back with adjustable lumbar support, three application-specific arm types and waterfall seat add great ergonomics and comfort to the equation. The eye-catching lumbar bands, curvaceous profile and soft, textured arm pads make this a stool that delivers style as well as substance.



Featured Models

GOOD :: \$648

Midback mesh, basic mechanism, black frame, armless, black nylon base, carpet casters, grade 1 textile

BETTER :: \$696

Midback mesh, basic mechanism, black frame, height-adjustable arms, black nylon base, carpet casters, grade 1 textile

BEST :: \$785

Midback mesh, basic mechanism, fog frame, multi-adjustable arms, extended stool kit, fog nylon base, carpet casters, grade 1 textile

Features

- Midback task stool
- Aerodynamic design
- Multiple frame, back support and arm color choices
- Adjustable lumbar support
- 10 bleach-cleanable mesh back colors
- Contrast stitching in 10 thread colors
- Waterfall seat
- Three arm styles with textured arm pads
- Black, fog or polished aluminum base
- Standard 300 lb weight capacity warranty

1. Back

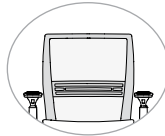
Back Size and Style	Code	Price	
Midback Mesh Task Stool With Adjustable Lumbar Support	2722 B1	\$696	

2. Mechanism

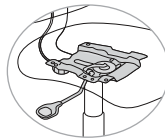

Mechanism Style	Code	Price	
Basic (Swivel Only)	B	+ \$0	

3. Frame

Frame Color	Code	Price	
Black	FC1	+ \$0	
Fog	FC13	+ \$35	

Frame color includes base, lumbar support band and arms.

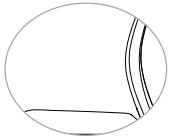
4. Arms

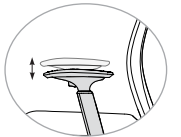
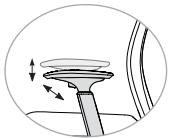
Arm Style	Code	Price	
Armless	A0	- \$48	
Fixed Polyurethane	A140	- \$10	
Height-Adjustable	A141	+ \$0	
Multi-Adjustable (Height/Width)	A142	+ \$30	

Arm color will match the frame. Arm pads are black except fixed polyurethane arm which matches frame color.

5. Base

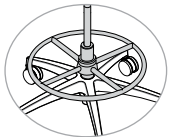
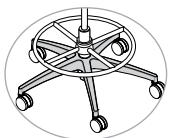
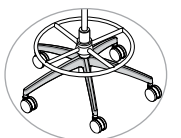
Base	Code	Price	
Stool Kit	S1	+ \$0	
Extended Stool Kit	S2	+ \$24	
Base Color and Material	Code	Price	
Black Nylon Base (For Black Frame – FC1)	B17	+ \$0	
Fog Nylon Base (For Fog Frame – FC13)	B21	+ \$0	
Polished Aluminum Base	B18	+ \$113	

Nylon bases pair only with their corresponding frame color. Polished aluminum base (B18) can be used with all frame colors.

5. Base (Cont.)

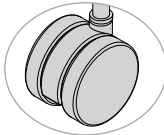
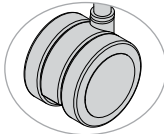
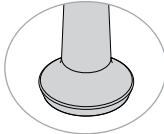
Casters or Glides	Code	Price	
Casters			
Black Carpet Casters	C16	+ \$0	
Black Hard Floor and Carpet Casters	C17	+ \$40	
Glides			
Glides for Task Chairs	C3	+ \$30	

6. Material

Protection	Code	Price	
CAL 133, Fabric, Quantities 1-49	133F	+ \$99	
CAL 133, Fabric, Quantities 50+	133F5	+ \$55	
CAL 133, Leather, Any Quantity	133L	+ \$119	
Mesh Color	Code	Price	
Apple	MC31	+ \$0	
Aqua	MC30	+ \$0	
Desert	MC9	+ \$0	
Electric Blue	MC24	+ \$0	
Fire	MC10	+ \$0	
Fog	MC7	+ \$0	
Navy	MC8	+ \$0	
Nickel	MC6	+ \$0	
Onyx	MC5	+ \$0	
Tangerine	MC28	+ \$0	

MESH BACK TASK STOOL

6. Material (Cont.)

Seat Textile	Code	Price	
COM	COM	+ \$0	
Fabric/Vinyl Grade 1	FG1/VG1	+ \$0	
Fabric/Vinyl Grade 2	FG2/VG2	+ \$26	
Fabric/Vinyl Grade 3	FG3/VG3	+ \$60	
Fabric/Vinyl Grade 4	FG4/VG4	+ \$116	
Fabric/Vinyl Grade 5	FG5/VG5	+ \$172	
Fabric/Vinyl Grade 6	FG6/VG6	+ \$213	
Fabric/Vinyl Grade 7	FG7/VG7	+ \$254	
COL	COL	+ \$300	
Leather Grade 1	LG1	+ \$300	
Leather Grade 2	LG2	+ \$380	
Leather Grade 3	LG3	+ \$480	
Contrast Stitching	Code	Price	
No Contrast Stitching	TC0	+ \$0	
Apple Thread	TC3	+ \$0	
Desert Thread	TC9	+ \$0	
Electric Blue Thread	TC4	+ \$0	
Fire Thread	TC10	+ \$0	
Fog Thread	TC7	+ \$0	
Lemon Thread	TC2	+ \$0	
Navy Thread	TC8	+ \$0	
Nickel Thread	TC6	+ \$0	
Onyx Thread	TC5	+ \$0	
White Thread	TC1	+ \$0	

Contrast stitching available only for SitOnIt Seating carded fabrics in solid colors. Please reference the Textile Reference Guide for pricing on fabric over grade 7 and leather over grade 3.

Packaging	Code	Price	
Knocked Down	KD	+ \$0	
Back Attached to Seat, Base Separate	UC	+ \$80	
Fully Assembled in Carton	AC	+ \$200	

SPECIFICATIONS

	2722 B1 S1 Task Stool	2722 B1 S2 Extended Task Stool
Overall Width Armless	24.5"	24.5"
Overall Width With Arms	27.75"-28.25"	27.75"-28.25"
Overall Depth	24.5"	24.5"
Overall Height	39"-46.5"	43.75"-53.38"
Seat Width	19.25"	19.25"
Seat Depth	17.75"	17.75"
Seat Height	21.5"-29.5"	25"-35"
Back Width	19.5"	19.5"
Back Height	20.37"	20.37"
Weight Armless	34 lb	35 lb
Weight With Arms	39.5 lb	40 lb
COM	1 yd	1 yd
COL	17 sq ft	17 sq ft
Weight Capacity	300 lb	300 lb



Amplify

UPHOLSTERED BACK TASK CHAIR

The power of more.

In keeping with the aerodynamic design of the well-regarded Amplify™ mesh model, the Amplify upholstered chair's sleek and slender profile proves that this is a chair that delivers style as well as substance.



Featured Models

GOOD :: \$636

Highback upholstered, black frame, swivel-tilt mechanism, fixed arms, black nylon base, carpet casters, grade 1 textile

BETTER :: \$696

Highback upholstered, black frame, enhanced synchro mechanism, height-adjustable arms, black nylon base, carpet casters, grade 1 textile

BEST :: \$840

Highback upholstered, fog frame, enhanced synchro mechanism with seat-depth adjustment, multi-adjustable arms, fog nylon base, carpet casters, grade 1 textile

Features

- Highback task chair
- Aerodynamic design
- Multiple frame, back support and arm color choices
- Adjustable lumbar support
- Enhanced synchro or swivel-tilt
- Waterfall seat
- Three arm styles with textured arm pads
- Black, fog, silver or polished aluminum base
- Optional seat-depth adjustment
- Standard 300 lb weight capacity warranty;
Heavy Duty Series 400 lb weight capacity warranty

1. Back

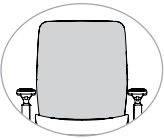
Back Size and Style	Code	Price	
Highback Upholstered With Dynamic Lumbar	2723 B3	\$696	

2. Heavy Duty

Heavy Duty Series	Code	Price	
Large and Tall (Black Highback Frame With Enhanced Synchro Y Mechanism and Sport Height-Adjustable Arms)	LT	+ \$250	

See page 38 for additional LT and HD options.

UPHOLSTERED BACK TASK CHAIR

3. Mechanism

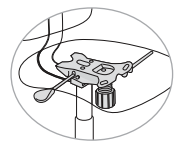
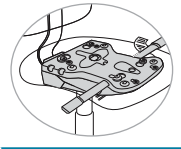
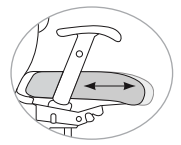
Mechanism Style	Code	Price	
Swivel-Tilt	T	- \$50	
Enhanced Synchro	Y	+ \$0	
Seat-Depth Adjustment	Code	Price	
Seat-Depth Adjustment	E3	+ \$79	

Seat-depth adjustment (E3) is not available on swivel-tilt (T) mechanism.



Better



4. Frame

Frame Color	Code	Price	
Black, Single-Color Nylon Frame	FC1	+ \$0	
Fog, Single-Color Nylon Frame	FC13	+ \$35	
Fog With Silver, Two-Color Nylon Frame	FC14	+ \$35	

Single-color nylon frame includes base, back support and arms.

Two-color nylon frame includes fog frame with silver back support and silver base. Adjustable arms are silver. Fixed arms are fog.

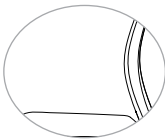
5. Arms

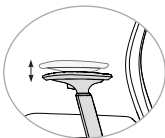
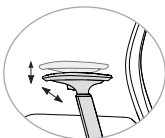
Arm Style	Code	Price	
Armless	A0	- \$48	
Fixed Polyurethane	A140	- \$10	
Height-Adjustable	A141	+ \$0	
Multi-Adjustable (Height/Width)	A142	+ \$30	

Arm color will match the frame. Arm pads are black except fixed polyurethane arm which matches frame color.

6. Base

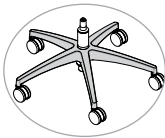
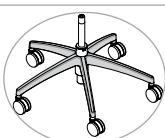
Base Color and Material	Code	Price	
Black Nylon Base (For Black Frame FC1)	B17	+ \$0	
Fog Nylon Base (For Fog Frame FC13)	B21	+ \$0	
Silver Nylon Base (For Fog Frame With Silver FC14)	B22	+ \$0	
Polished Aluminum Base	B18	+ \$113	

Nylon bases pair only with their corresponding frame color. Polished aluminum base (B18) can be used with all frame colors.

UPHOLSTERED BACK TASK CHAIR

6. Base (Cont.)

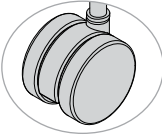
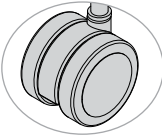
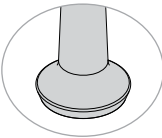
Casters or Glides	Code	Price	
Casters			
Black Carpet Casters	C16	+ \$0	
Black Hard Floor and Carpet Casters	C17	+ \$40	
Glides			
Glides for Task Chairs	C3	+ \$30	
Cylinder Height			
Standard Cylinder	S0	+ \$0	
Higher Cylinder	S13	+ \$0	

7. Material

Protection	Code	Price	
CAL 133, Fabric, Quantities 1-49	133F	+ \$99	
CAL 133, Fabric, Quantities 50+	133F5	+ \$55	
CAL 133, Leather, Any Quantity	133L	+ \$119	
Seat and Back Textile			
COM	COM	+ \$0	
Fabric/Vinyl Grade 1	FG1/VG1	+ \$0	
Fabric/Vinyl Grade 2	FG2/VG2	+ \$34	
Fabric/Vinyl Grade 3	FG3/VG3	+ \$74	
Fabric/Vinyl Grade 4	FG4/VG4	+ \$121	
Fabric/Vinyl Grade 5	FG5/VG5	+ \$174	
Fabric/Vinyl Grade 6	FG6/VG6	+ \$235	
Fabric/Vinyl Grade 7	FG7/VG7	+ \$296	
COL	COL	+ \$320	
Leather Grade 1	LG1	+ \$320	
Leather Grade 2	LG2	+ \$420	
Leather Grade 3	LG3	+ \$540	

Please reference the Textile Reference Guide for pricing on fabric over grade 7 and leather over grade 3.

8. Packaging

Packaging	Code	Price
Knocked Down	KD	+ \$0
Back Attached to Seat, Base Separate	UC	+ \$80
Fully Assembled in Carton	AC	+ \$200

SPECIFICATIONS

	2723 B3 Highback Upholstered Task Chair	2723 B3 LT Large and Tall Upholstered Task Chair
Overall Width Armless	26"	26"
Overall Width With Arms	27.75"	27.75"
Overall Depth	24.5"	27.75"
Overall Height	42"	42"
Seat Width	19.25"	22"
Seat Depth	17.5"-19.75"	17.5"-19.75"
Seat Height With Standard Cylinder (S0)	16.5"-20.12" (T) 16.5"-20.35" (Y)	N/A 17.5"-21.5" (Y)
Seat Height With Higher Cylinder (S13)	17.5"-21.87" (T) 18"-22.5" (Y)	N/A 18"-23" (Y)
Back Width	18.5"	18.5"
Back Height	22"	22"
Weight Armless	35 lb	45 lb
Weight With Arms	40 lb	51 lb
COM	1.25 yd	1.25 yd
COL	23 sq ft	23 sq ft
Weight Capacity	300 lb	400 lb

Swivel tilt mechanism (T). Enhanced synchro mechanism (Y).



Amplify

UPHOLSTERED BACK TASK STOOL

The power of more.

In keeping with the aerodynamic design of the well-regarded Amplify™ mesh model, the Amplify upholstered chair's sleek and slender profile proves that this is a stool that delivers style as well as substance.



Featured Models

GOOD :: \$697

Highback upholstered, basic mechanism, black frame, armless, black nylon base, carpet casters, grade 1 textile

BETTER :: \$745

Highback upholstered, basic mechanism, black frame, height-adjustable arms, black nylon base, black carpet casters, grade 1 textile

BEST :: \$834

Highback upholstered, basic mechanism, fog frame, multi-adjustable arms, extended stool kit, fog nylon base, carpet casters, grade 1 textile

Features

- Highback task stool
- Aerodynamic design
- Multiple frame, back support and arm color choices
- Adjustable lumbar support
- Waterfall seat
- Three arm styles with textured arm pads
- Black, fog or polished aluminum base
- Standard 300 lb weight capacity warranty

1. Back

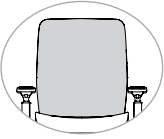
Back Size and Style	Code	Price	
Highback Upholstered Task Stool With Dynamic Lumbar	2723 B3	\$745	

2. Mechanism

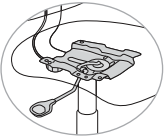
Mechanism Style	Code	Price	
Basic (Swivel Only)	B	+ \$0	

3. Frame



Frame Color	Code	Price	
Black, Single-Color Nylon Frame	FC1	+ \$0	
Fog, Single-Color Nylon Frame	FC13	+ \$35	
Fog With Silver, Two-Color Nylon Frame	FC14	+ \$35	

Single-color frame includes base, lumbar support band and arms.

Two-color frame includes fog frame with silver back support and silver base. Adjustable arms are silver. Fixed arms are fog.

UPHOLSTERED BACK TASK STOOL

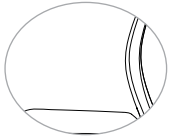
4. Arms

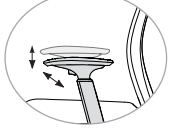
Arm Style	Code	Price	
Armless	A0	- \$48	
Fixed Polyurethane	A140	- \$10	
Height-Adjustable	A141	+ \$0	
Multi-Adjustable (Height/Width)	A142	+ \$30	

Arm color will match the frame. Arm pads are black except fixed polyurethane arm (A140) which matches frame color.



Better

5. Base

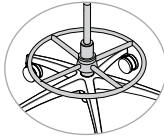
Base	Code	Price	
Stool Kit	S1	+ \$0	
Extended Stool Kit	S2	+ \$24	

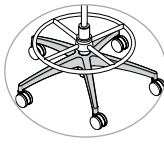
Base Color and Material	Code	Price	
Black Nylon Base (For Black Frame FC1)	B17	+ \$0	
Fog Nylon Base (For Fog Frame FC13)	B21	+ \$0	
Silver Nylon Base (For Fog Frame With Silver FC14)	B22	+ \$0	

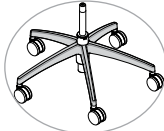
Polished Aluminum Base	B18	+ \$113	
------------------------	-----	---------	---

Casters or Glides	Code	Price	
Casters			

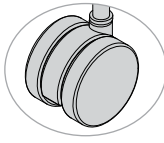
Black Carpet Casters	C16	+ \$0	
----------------------	-----	-------	--

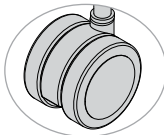
Black Hard Floor and Carpet Casters	C17	+ \$40	
-------------------------------------	-----	--------	---

Glides			
--------	--	--	--

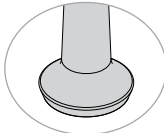
Glides for Task Chairs	C3	+ \$30	
------------------------	----	--------	---

Nylon bases pair only with their corresponding frame color. Polished aluminum base (B18) can be used with all frame colors.

6. Material

Protection	Code	Price	
CAL 133, Fabric, Quantities 1-49	133F	+ \$99	
CAL 133, Fabric, Quantities 50+	133F5	+ \$55	
CAL 133, Leather, Any Quantity	133L	+ \$119	

UPHOLSTERED BACK TASK STOOL

6. Material

Seat and Back Textile	Code	Price	
COM	COM	+ \$0	
Fabric/Vinyl Grade 1	FG1/VG1	+ \$0	
Fabric/Vinyl Grade 2	FG2/VG2	+ \$34	
Fabric/Vinyl Grade 3	FG3/VG3	+ \$74	
Fabric/Vinyl Grade 4	FG4/VG4	+ \$121	
Fabric/Vinyl Grade 5	FG5/VG5	+ \$174	
Fabric/Vinyl Grade 6	FG6/VG6	+ \$235	
Fabric/Vinyl Grade 7	FG7/VG7	+ \$296	
COL	COL	+ \$320	
Leather Grade 1	LG1	+ \$320	
Leather Grade 2	LG2	+ \$420	
Leather Grade 3	LG3	+ \$540	

Please reference the *Textile Reference Guide* for pricing on fabric over grade 7 and leather over grade 3.

7. Packaging

Protection	Code	Price	
Knocked Down	KD	+ \$0	
Back Attached to Seat, Base Separate	UC	+ \$80	
Fully Assembled in Carton	AC	+ \$200	

SPECIFICATIONS

	2723 B3 S1 Task Stool	2723 B3 S2 Extended Task Stool
Overall Width Armless	24.5"	24.5"
Overall Width With Arms	27.75"-28.25"	27.75"-28.25"
Overall Depth	24.5"	24.5"
Overall Height	40.75"-48.25"	45.5"-55.13"
Seat Width	19.25"	19.25"
Seat Depth	17.75"	17.75"
Seat Height	21.5"-29.5"	25"-35"
Back Width	18.5"	18.5"
Back Height	22"	22"
Weight Armless	35.5 lb	36 lb
Weight With Arms	40.5 lb	41 lb
COM	1.25 yd	1.25 yd
COL	23 sq ft	23 sq ft
Weight Capacity Warranty	300 lb	300 lb

Anytime

LIGHT TASK CHAIR AND TASK STOOL

*Grab and go.
Anywhere.*

The Anytime™ light task chair and stool pair perfectly with the Anytime side chair to make a complete set. Featuring the versatility that is the signature of the collection along with a perforated shell and a built-in pull handle, Anytime makes any office, meeting or training room a work space.



Featured Models

GOOD :: \$439

All plastic, basic mechanism, armless, carpet casters

BETTER :: \$497

Plastic back and upholstered seat, swivel-tilt mechanism, armless, carpet casters



BEST :: \$613

Fully upholstered, swivel-tilt mechanism, fixed arms, carpet casters



Features

- Light task chair and light task stool
- Fully upholstered, upholstered seat only or plastic
- Nine plastic colors
- Perforated shell provides ventilation
- Built-in pull handle
- Black or silver tubular frame
- 250 lb weight capacity
- Complements Anytime multipurpose chair and bar stool; see page 196

1. Back

Seat and Back Style	Code	Price	
Plastic	No Code	\$439	
Upholstered Seat Only	US	\$497	
Upholstered Seat and Back	UP	\$555	

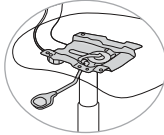

2. Mechanism

Mechanism Style	Code	Price	
Basic (Swivel Only)	B	- \$50	
Swivel-Tilt	T	+ \$0	



Swivel-tilt mechanism (T) is not available for task stool (S1) or extended task stool (S2).

LIGHT TASK CHAIR AND TASK STOOL



3. Frame

Frame Type	Code	Price	
Task Chair	93T	+ \$0	
Task Stool	93T S1	+ \$132	
Extended Task Stool	93T S2	+ \$156	

4. Arms

Arm Style	Code	Price	
Armless	A0	+ \$0	
Fixed Loop Arms	A48	+ \$58	

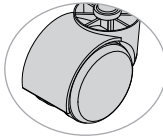
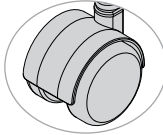
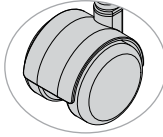
5. Base

Casters and Glides	Code	Price	
Casters			
Carpet Casters	C6	+ \$0	
Hard Floor and Carpet Casters	C1	+ \$40	
Self-Locking Carpet Casters	C2	+ \$30	
Self-Locking Hard Floor and Carpet Casters	C7	+ \$61	

5. Base

Casters and Glides	Code	Price	
Glides			

Glides for Task Chairs	C3	+ \$30	
------------------------	----	--------	--

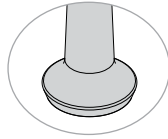

Self-locking casters (C2/C7) lock only when not in use.

6. Material

Protection	Code	Price	
CAL 133, Fabric, Quantities 1-49	133F	+ \$99	

CAL 133, Fabric, Quantities 50+	133F5	+ \$55	
---------------------------------	-------	--------	--

CAL 133, Plastic, Any Quantity	133P	+ \$45	
--------------------------------	------	--------	--

Shell Color	Code	Price	
-------------	------	-------	--

Arctic	SC21	+ \$0	
--------	------	-------	--

Black	SC1	+ \$0	
-------	-----	-------	--

Chocolate	SC4	+ \$0	
-----------	-----	-------	--

Lagoon	SC15	+ \$0	
--------	------	-------	--

Latte	SC20	+ \$0	
-------	------	-------	--

Navy	SC5	+ \$0	
------	-----	-------	--

Red	SC19	+ \$0	
-----	------	-------	--

Slate	SC8	+ \$0	
-------	-----	-------	--

Sterling	SC18	+ \$0	
----------	------	-------	--

Textile	Code	Price	
---------	------	-------	--

Seat Textile Only (For US)			
----------------------------	--	--	--

COM	COM	+ \$0	
-----	-----	-------	--

Fabric/Vinyl Grade 1	FG1/VG1	+ \$0	
----------------------	---------	-------	--

Fabric/Vinyl Grade 2	FG2/VG2	+ \$22	
----------------------	---------	--------	--

Fabric/Vinyl Grade 3	FG3/VG3	+ \$45	
----------------------	---------	--------	--

Fabric/Vinyl Grade 4	FG4/VG4	+ \$77	
----------------------	---------	--------	--

Fabric/Vinyl Grade 5	FG5/VG5	+ \$116	
----------------------	---------	---------	--

Fabric/Vinyl Grade 6	FG6/VG6	+ \$159	
----------------------	---------	---------	--

Fabric/Vinyl Grade 7	FG7/VG7	+ \$200	
----------------------	---------	---------	--

LIGHT TASK CHAIR AND TASK STOOL

6. Material

Textile	Code	Price	
Seat and Back Textile (For UP)			

COM	COM	+ \$0	
-----	-----	-------	--

Fabric/Vinyl Grade 1	FG1/VG1	+ \$0	
----------------------	---------	-------	--

Fabric/Vinyl Grade 2	FG2/VG2	+ \$34	
----------------------	---------	--------	--

Fabric/Vinyl Grade 3	FG3/VG3	+ \$74	
----------------------	---------	--------	--

Fabric/Vinyl Grade 4	FG4/VG4	+ \$121	
----------------------	---------	---------	--

Fabric/Vinyl Grade 5	FG5/VG5	+ \$174	
----------------------	---------	---------	--

Fabric/Vinyl Grade 6	FG6/VG6	+ \$235	
----------------------	---------	---------	--

Fabric/Vinyl Grade 7	FG7/VG7	+ \$296	
----------------------	---------	---------	--

Please reference the *Textile Reference Guide* for pricing on fabric over grade 7.

7. Packaging

Packaging	Code	Price	
-----------	------	-------	--

Back Attached to Seat, Base Separate	UC	+ \$0	
--------------------------------------	----	-------	--

Fully Assembled in a Carton	AC	+ \$120	
-----------------------------	----	---------	--

SPECIFICATIONS

	93T Task	93T S1 Task Stool	93T S2 Extended Task Stool
Overall Width Armless	26"	26"	26"
Overall Width With Arms	26.5"	26.5"	26.5"
Overall Depth	26"	26"	26"
Overall Height	35.5"	39"	43"
Seat Width	19"	19"	19"
Seat Depth	18"	18"	18"
Seat Height	16"-21"	16.6"-27"	23.5"-33.5"
Back Width	21.5"	21.5"	21.5"
Back Height	14.5"	14.5"	14.5"
Weight Armless	29.5 lb	39.5 lb	39.5 lb
Weight With Arms	33.4 lb	44.4 lb	44.4 lb
COM	0.8 yd (US) 1 yd (UP)	0.8 yd (US) 1 yd (UP)	0.8 yd (US) 1 yd (UP)
Weight Capacity Warranty	250 lb	250 lb	250 lb

Focus

MESH BACK TASK CHAIR

Where comfort, style and ergonomics converge.

Experience something so comfortable it hardly ever crosses your mind—from the moment you sit down until it's time to head home. Our best-selling seating solution works just about anywhere you need thanks to a wider back frame, extra-deep seat and almost endless options to customize.

Our signature dual-curve frame takes its cues from modern, industrial design while also reinforcing key points of contact, so your back is optimally supported throughout the day.



Best

Featured Models

GOOD :: \$591

Midback, swivel-tilt mechanism, height-adjustable arms, nylon base, grade 1 textile

BETTER :: \$693

Highback, enhanced synchro mechanism, height-adjustable arms, nylon base, grade 1 textile

BEST :: \$888

Highback, adjustable lumbar, enhanced synchro mechanism with seat-depth adjustment, fully multi-adjustable (10-way) sport arms, nylon base, grade 1 textile

Features

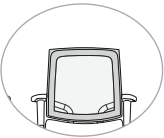
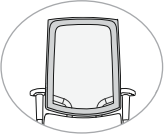
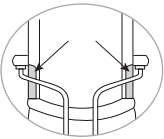

- Ergonomic back support and comfort
- Midback and highback
- Looser-weave mesh for extra breathability
- Five bleach-cleanable mesh colors
- Adjustable lumbar option
- Nine ergonomic arm styles with standard or sport arm pads
- Black or silver accents
- Waterfall seat
- Optional sport casters
- Complements Focus Side chair, counter and bar stool; see page 203
- Standard 300 lb weight capacity warranty; Heavy Duty Series - 350 lb and 400 lb weight capacity options

1. Back

Back Size and Style	Code	Price	
Midback Mesh	5622 B1	\$661	
Highback Mesh	5623 B1	\$693	
Back Options	Code	Price	
Adjustable Lumbar Support	LB1	+ \$50	



MESH BACK TASK CHAIR

2. Heavy Duty

Heavy Duty Series	Code	Price	
Heavy Duty	HD	+ \$126	
Large and Tall (Black Highback Frame With Enhanced Synchro Y Mechanism and Sport Height-Adjustable A152 Arms)	LT	+ \$250	

Heavy duty model (HD) is only available with enhanced synchro (Y) mechanism. Heavy Duty model (HD) is not available with fixed arms (A91). See for additional LT and HD options.

3. Mechanism

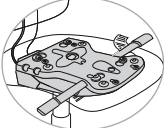
Mechanism Style	Code	Price	
Swivel-Tilt	T	- \$70	
Knee-Tilt	K	- \$57	
Enhanced Synchro	Y	+ \$0	

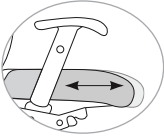
Seat-Depth Adjustment	Code	Price	
Seat-Depth Adjustment	E3	+ \$79	

Seat-depth adjustment (E3) available with enhanced synchro (Y) mechanism only.

4. Frame

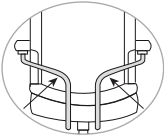
Back Support Color	Code	Price	
Black	Z1	+ \$0	
Silver	Z2	+ \$0	



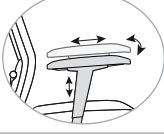

5. Arms

Arm Style	Code	Price	
Armless	A0	- \$90	
Fixed Arms	A91	- \$15	
Height-Adjustable	A92	+ \$0	
Height-Adjustable With Sport Arm Pads	A152	+ \$0	
Height-/Width-Adjustable	A93	+ \$25	
Height-/Width-Adjustable With Sport Arm Pads	A153	+ \$25	
Fully Adjustable (6-Way)	A94	+ \$56	
Fully Adjustable (6-Way) With Sport Arm Pads	A154	+ \$56	
Fully Multi-Adjustable (10-Way)	A95	+ \$66	
Fully Multi-Adjustable (10-Way) With Sport Arm Pads	A155	+ \$66	

Fixed arms (A91) not available with enhanced synchro (Y) mechanism.

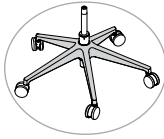
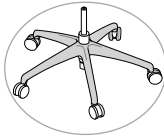
MESH BACK TASK CHAIR

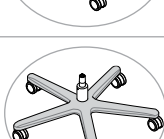
6. Base

Base Color and Style	Code	Price	
Black Nylon	B0	+ \$0	
High Profile Polished Aluminum Base	B3	+ \$113	
High Profile Brushed Aluminum Base	B8	+ \$113	
Low Profile Base With Higher Cylinder	S8	+ \$0	
Heavy Duty Bases (For HD/LT)			
Black Nylon Base, 26"	B7	+ \$0	
Polished Aluminum Base	B5	+ \$167	

Low profile base (S8) only available with enhanced synchro (Y) mechanism.



Good

6. Base (Cont.)

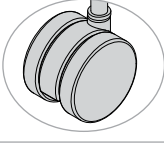
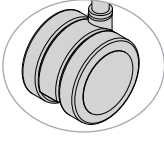
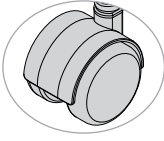
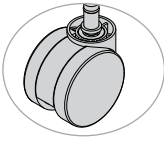
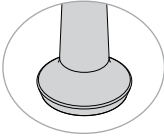
Casters or Glides	Code	Price	
Casters			
Carpet Casters	C15	+ \$0	
Sport Carpet Casters	C31	+ \$0	
Sport Hard Floor and Carpet Casters	C32	+ \$40	
Hard Floor and Carpet Casters	C14	+ \$40	
Self-Locking Carpet Casters	C20	+ \$30	
Self-Locking Hard Floor and Carpet Casters	C19	+ \$64	
Heavy Duty Casters (For HD and LT)			
Heavy Duty Carpet Casters	C11	+ \$0	
Heavy Duty Hard Floor and Carpet Casters	C9	+ \$61	
Glides			
Glides for Task Chairs	C3	+ \$30	

Self-locking casters (C19/C20) lock only when not in use.

MESH BACK TASK CHAIR

7. Material

Protection	Code	Price	
CAL 133, Fabric, Quantities 1–49	133F	+ \$99	
CAL 133, Fabric, Quantities 50+	133F5	+ \$55	
CAL 133, Leather, Any Quantity	133L	+ \$119	
Mesh Color			
Black	MC1	+ \$0	
Sand	MC3	+ \$0	
Slate	MC2	+ \$0	
Freeway Sport Stripe (Black/Slate)	MC33	+ \$0	
Impress Sport Stripe (Slate/Black)	MC34	+ \$0	
Seat Textile			
COM	COM	+ \$0	
Fabric/Vinyl Grade 1	FG1/VG1	+ \$0	
Fabric/Vinyl Grade 2	FG2/VG2	+ \$26	
Fabric/Vinyl Grade 3	FG3/VG3	+ \$60	
Fabric/Vinyl Grade 4	FG4/VG4	+ \$116	
Fabric/Vinyl Grade 5	FG5/VG5	+ \$172	
Fabric/Vinyl Grade 6	FG6/VG6	+ \$213	
Fabric/Vinyl Grade 7	FG7/VG7	+ \$254	
COL	COL	+ \$300	
Leather Grade 1	LG1	+ \$300	
Leather Grade 2	LG2	+ \$380	
Leather Grade 3	LG3	+ \$480	

Sport striped meshes list the predominant color first.

Please reference the Textile Reference Guide for pricing on fabric over grade 7 and leather over grade 3.

Packaging	Code	Price	
Knocked Down	KD	+ \$0	
Back Attached to Seat, Base Separate	UC	+ \$80	
Fully Assembled in Carton	AC	+ \$200	

8. Packaging

SPECIFICATIONS

	5622 B1 Midback Mesh Task Chair	5623 B1 Highback Mesh Task Chair
Overall Width Armless	26"	26"
Overall Width With Arms	27.3"	27.5"
Overall Depth	25"	26"
Overall Height	35" 35.5" (B3/B8)	39" 39.5" (B3/B8)
Seat Width	19"	19"
Seat Depth	18.5"-20.75"	18.5"-20.75"
Seat Height	16.5"-20.125" (T) 17.5"-20.5" (K) 16.75"-20.75" (Y)	16.5"-20.125" (T) 17.5"-20.5" (K) 16.75"-20.75" (Y)
	16.88"-20.25" (Y) (B3/B8)	16.88"-20.25" (Y) (B3/B8)
Back Width	18.25"	18.3"
Back Height	20"	23.5"
Weight Armless	35.5 lb	36.5 lb
Weight With Arms	41.5 lb	42.5 lb
COM	1 yd	1 yd
COL	17 sq ft	17 sq ft
Weight Capacity	300 lb	300 lb
Warranty	350 lb (HD)	350 lb (HD)

Swivel-tilt mechanism (T). Knee-tilt mechanism (K). Enhanced synchro mechanism (Y). High profile polished aluminum base (B3). High profile brushed aluminum base (B8). Heavy Duty (HD).

MESH BACK TASK CHAIRS

SPECIFICATIONS: LARGE AND TALL

	5623 B1 LT Highback Mesh Large and Tall Task Chair
Overall Width Armless	26"
Overall Width With Arms	29"
Overall Depth	27.75"
Overall Height Base	38" (B7), 39" (B5)
Seat Width	22"
Seat Depth	17.5"
Seat Height	17.5"-21.5" (Y) (B7) 16.88"-20.25" (Y) (B5)
Back Width	18.3"
Back Height	21.5"
Weight Armless	47 lb
Weight With Arms	53 lb
COM	1.15 yd
COL	25 sq ft
Weight Capacity	400 lb
Warranty	

Enhanced synchro mechanism (Y). Heavy Duty black nylon base (B7). Heavy duty polished aluminum base (B5).



Better

Focus

MESH BACK TASK STOOL

Where comfort, style and ergonomics converge.

Experience something so comfortable it hardly ever crosses your mind—from the moment you sit down until it's time to head home. Our best-selling seating solution works just about anywhere you need thanks to a wider back frame, extra-deep seat and almost endless options to customize.

Our signature dual-curve frame takes its cues from modern, industrial design while also reinforcing key points of contact, so your back is optimally supported throughout the day.



Featured Models

GOOD :: \$620

Midback mesh task stool, basic mechanism, armless, nylon base, grade 1 textile

BETTER :: \$742

Highback mesh task stool, basic mechanism, height-adjustable arms, nylon base, grade 1 textile

BEST :: \$841

Highback mesh task stool with adjustable lumbar support, basic mechanism, height-/width-adjustable arms, extended stool kit, nylon base, grade 1 textile

MESH BACK TASK STOOL

Features

- Ergonomic back support and comfort
- Midback and highback
- Looser-weave mesh for extra breathability
- Five bleach-cleanable mesh colors
- Adjustable lumbar option
- Nine ergonomic arm styles with standard or Sport arm pads
- Black or silver accents
- Waterfall seat
- Optional Sport casters
- Complements Focus Side chair, counter and bar stool; see page 203
- Standard 300 lb weight capacity warranty

1. Back

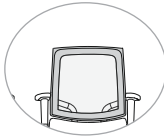
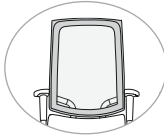
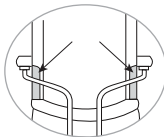
Back Size and Style	Code	Price	
Midback Mesh	5622 B1	\$710	
Highback Mesh	5623 B1	\$742	
Back Options	Code	Price	
Adjustable Lumbar Support	LB1	+\$50	

2. Mechanism

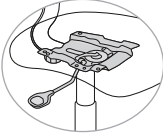
Mechanism Style	Code	Price	
Basic (Swivel Only)	B	+\$0	

3. Frame

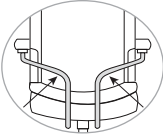
Back Support Color	Code	Price	
Black	Z1	+\$0	
Silver	Z2	+\$0	





4. Arms

Arm Style	Code	Price	
Armless	A0	- \$90	
Fixed Arms	A91	- \$15	
Height-Adjustable	A92	+ \$0	
Height-Adjustable With Sport Arm Pads	A152	+ \$0	
Height-/Width-Adjustable	A93	+ \$25	
Height-/Width-Adjustable With Sport Arm Pads	A153	+ \$25	
Fully Adjustable (6-Way)	A94	+ \$56	
Fully Adjustable (6-Way) With Sport Arm Pads	A154	+ \$56	
Fully Multi-Adjustable (10-Way)	A95	+ \$66	
Fully Multi-Adjustable (10-Way) With Sport Arm Pads	A155	+ \$66	

MESH BACK TASK STOOL

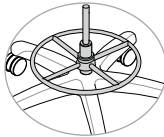
5. Base

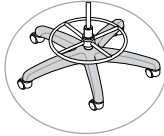
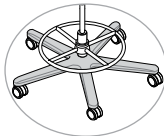
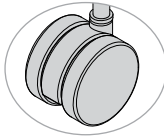
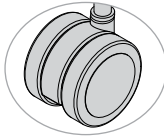
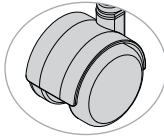
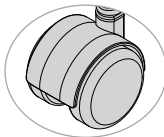
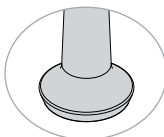
Base	Code	Price	
Stool Kit	S1	+ \$0	
Extended Stool Kit	S2	+ \$24	
Base Color and Material	Code	Price	
Black Nylon Base	B6	+ \$0	
Polished Aluminum Base	B5	+ \$167	
Casters or Glides	Code	Price	
Casters			
Carpet Casters	C5	+ \$0	
Carpet Casters (For Higher Cylinder)	C21	+ \$0	
Sport Carpet Casters	C31	+ \$0	
Sport Hard Floor and Carpet Casters	C32	+ \$40	
Hard Floor and Carpet Casters	C1	+ \$40	
Hard Floor and Carpet Casters (For Higher Cylinder)	C22	+ \$40	
Self-Locking Carpet Casters	C2	+ \$30	
Self-Locking Hard Floor and Carpet Casters	C7	+ \$61	
Glides			
Glides for Task Chairs	C3	+ \$30	

Self-locking casters (C2/C7) lock only when not in use.

6. Material

Protection	Code	Price
CAL 133, Fabric, Quantities 1-49	133F	+ \$99

CAL 133, Fabric, Quantities 50+	133F5	+ \$55
---------------------------------	-------	--------

CAL 133, Leather, Any Quantity	133L	+ \$119
--------------------------------	------	---------

Mesh Color	Code	Price
Black	MC1	+ \$0
Sand	MC3	+ \$0
Slate	MC2	+ \$0
Freeway Sport Stripe (Black/Slate)	MC33	+ \$0
Impress Sport Stripe (Slate/Black)	MC34	+ \$0

Seat Textile	Code	Price
COM	COM	+ \$0
Fabric/Vinyl Grade 1	FG1/VG1	+ \$0
Fabric/Vinyl Grade 2	FG2/VG2	+ \$26
Fabric/Vinyl Grade 3	FG3/VG3	+ \$60
Fabric/Vinyl Grade 4	FG4/VG4	+ \$116
Fabric/Vinyl Grade 5	FG5/VG5	+ \$172
Fabric/Vinyl Grade 6	FG6/VG6	+ \$213
Fabric/Vinyl Grade 7	FG7/VG7	+ \$254
COL	COL	+ \$300
Leather Grade 1	LG1	+ \$300
Leather Grade 2	LG2	+ \$380
Leather Grade 3	LG3	+ \$480

Sport striped meshes list the predominant color first.

Please reference the Textile Reference Guide for pricing on fabric over grade 7 and leather over grade 3.

7. Packaging

Packaging	Code	Price
Knocked Down	KD	+ \$0
Back Attached to Seat, Base Separate	UC	+ \$80
Fully Assembled in a Carton	AC	+ \$200

MESH BACK TASK STOOL

MIDBACK SPECIFICATIONS

	5622 B1 S1 Midback Mesh Task Stool	5622 B1 S2 Midback Mesh Extended Task Stool
Overall Width Armless	27.3"	27.3"
Overall Width With Arms	27.3"	27.3"
Overall Depth	25"	25"
Overall Height	41.6"	46"
Seat Width	19"	19"
Seat Depth	18.5"	18.5"
Seat Height	21"-29"	24"-34"
Back Width	18.25"	18.25"
Back Height	20"	20"
Weight Armless	39.5 lb	40.5 lb
Weight With Arms	45.5 lb	46.5 lb
COM	1 yd	1 yd
COL	17 sq ft	17 sq ft
Weight Capacity Warranty	300 lb	300 lb

HIGHBACK SPECIFICATIONS

	5623 B1 S1 Highback Mesh Task Stool	5623 B1 S2 Highback Mesh Extended Task Stool
Overall Width Armless	20"	20"
Overall Width With Arms	27.5"	27.5"
Overall Depth	26"	26"
Overall Height	45"	50"
Seat Width	20"	20"
Seat Depth	18.5"	18.5"
Seat Height	21"-29"	24"-34"
Back Width	18.3"	18.3"
Back Height	23.5"	23.5"
Weight Armless	40.5 lb	41.5 lb
Weight With Arms	46.5 lb	47.5 lb
COM	1 yd	1 yd
COL	17 sq ft	17 sq ft
Weight Capacity Warranty	300 lb	300 lb

FOCUS

UPHOLSTERED BACK TASK CHAIR

Where comfort, style and ergonomics converge.

Experience something so comfortable it hardly ever crosses your mind—from the moment you sit down until it's time to head home. Our best-selling seating solution works just about anywhere you need thanks to a wider back frame, extra-deep seat and almost endless options to customize.

Our signature dual-curve frame takes its cues from modern, industrial design while also reinforcing key points of contact, so your back is optimally supported throughout the day.



Featured Models

GOOD :: \$717

Midback upholstered pad, swivel-tilt mechanism, height-adjustable arms, nylon base, carpet casters, grade 1 textile

BETTER :: \$819

Highback upholstered pad, enhanced synchro mechanism, height-adjustable arms, nylon base, carpet casters, grade 1 textile

BEST :: \$1,014

Highback upholstered pad, adjustable lumbar, enhanced synchro mechanism with seat depth adjustment, fully multi-adjustable (10-way) sport arms, nylon base, carpet casters, grade 1 textile

Features

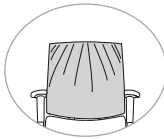
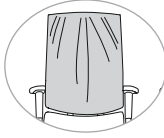

- Ergonomic back support and comfort
- Midback and highback
- Relaxed-fit upholstered pad
- Adjustable lumbar option
- Nine ergonomic arm styles with standard or Sport arm pads
- Black or silver accents
- Waterfall seat
- Optional Sport casters
- Complemented by Focus Side chair, counter and bar stool; see page 203
- Standard 300 lb weight capacity warranty; Heavy Duty Series - 350 lb and 400 lb weight capacities

1. Back

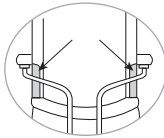
Back Size and Style	Code	Price	
Midback Relaxed-Fit Upholstered Pad	5622 B4	\$787	
Highback Relaxed-Fit Upholstered Pad	5623 B4	\$819	



Back Options	Code	Price	
Adjustable Lumbar Support	LB1	+ \$50	

2. Heavy Duty

Heavy Duty Series	Code	Price	
Heavy Duty	HD	+ \$126	
Large and Tall (Black Highback Frame With Enhanced Synchro Y Mechanism and Sport Height-Adjustable A152 Arms)	LT	+ \$250	

Heavy Duty model (HD) only available with enhanced synchro (Y) mechanism. See page 38 for additional options Heavy Duty and Large and Tall options.

3. Mechanism

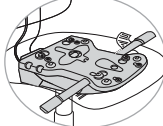
Mechanism	Code	Price	
Swivel-Tilt	T	- \$70	
Knee-Tilt	K	- \$57	
Enhanced Synchro	Y	+ \$0	

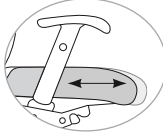

Seat-Depth Adjustment	Code	Price	
Seat-Depth Adjustment	E3	+ \$79	

Seat-depth adjustment (E3) available with enhanced synchro (Y) mechanism only.

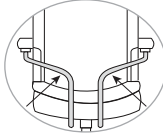
4. Frame

Back Support Color	Code	Price	
Black	Z1	+ \$0	
Silver	Z2	+ \$0	

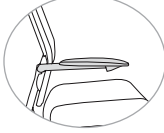

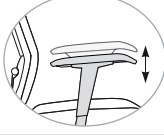
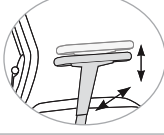
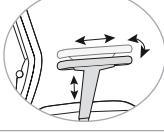
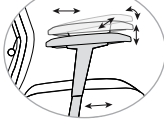

5. Arms

Arm Style	Code	Price	
Armless	A0	- \$90	
Fixed Arms	A91	- \$15	
Height-Adjustable	A92	+ \$0	
Height-Adjustable With Sport Arm Pads	A152	+ \$0	
Height-/Width-Adjustable	A93	+ \$25	
Height-/Width-Adjustable With Sport Arm Pads	A153	+ \$25	
Fully Adjustable (6-Way)	A94	+ \$56	
Fully Adjustable (6-Way) With Sport Arm Pads	A154	+ \$56	
Fully Multi-Adjustable (10-Way)	A95	+ \$66	
Fully Multi-Adjustable (10-Way) With Sport Arm Pads	A155	+ \$66	

Fixed arms (A91) are not available with the enhanced synchro (Y) mechanism.

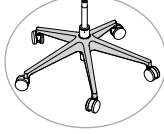
UPHOLSTERED BACK TASK CHAIR

6. Base

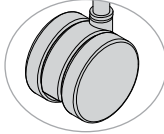
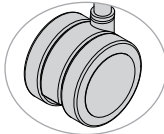
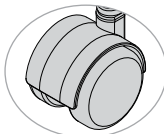
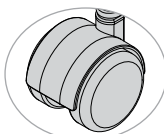
Base and Color	Code	Price	
Black Nylon Base	B0	+ \$0	
High Profile Polished Aluminum Base	B3	+ \$113	
High Profile Brushed Aluminum Base	B8	+ \$113	
Low Profile Nylon Base With Higher Cylinder	S8	+ \$0	
Heavy Duty Bases (For HD/LT)			
Black Nylon Base, 26"	B7	+ \$0	
Polished Aluminum	B5	+ \$167	
Casters or Glides	Code	Price	
Casters			
Carpet Casters	C15	+ \$0	
Sport Carpet Casters	C31	+ \$0	
Sport Hard Floor and Carpet Casters	C32	+ \$40	
Hard Floor and Carpet Casters	C14	+ \$40	
Self-Locking Carpet Casters	C20	+ \$30	
Self-Locking Hard Floor and Carpet Casters	C19	+ \$64	

Low profile base (S8) only available with enhanced synchro (Y) mechanism.
Heavy Duty bases (B5/B7) are for use with the HD and LT models.

6. Base (Cont.)

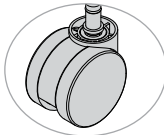
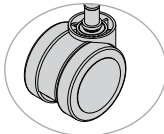
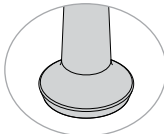
Casters or Glides	Code	Price	
Heavy Duty Casters (For HD and LT)			
Heavy Duty Carpet Casters	C11	+ \$0	
Heavy Duty Hard Floor and Carpet Casters	C9	+ \$61	
Glides			
Glides for Task Chairs	C3	+ \$30	

Self-locking casters (C20/C19) lock only when not in use.

7. Material

Protection	Code	Price	
CAL 133, Fabric, Quantities 1–49	133F	+ \$99	
CAL 133, Fabric, Quantities 50+	133F5	+ \$55	
CAL 133, Leather, Any Quantity	133L	+ \$119	
Seat and Back Textile	Code	Price	
COM	COM	+ \$0	
Fabric/Vinyl Grade 1	FG1/VG1	+ \$0	
Fabric/Vinyl Grade 2	FG2/VG2	+ \$34	
Fabric/Vinyl Grade 3	FG3/VG3	+ \$74	
Fabric/Vinyl Grade 4	FG4/VG4	+ \$121	
Fabric/Vinyl Grade 5	FG5/VG5	+ \$174	
Fabric/Vinyl Grade 6	FG6/VG6	+ \$235	
Fabric/Vinyl Grade 7	FG7/VG7	+ \$296	
COL	COL	+ \$260	
Leather Grade 1	LG1	+ \$260	
Leather Grade 2	LG2	+ \$320	
Leather Grade 3	LG3	+ \$400	

Please reference the Textile Reference Guide for pricing on fabric over grade 7 and leather over grade 3.

UPHOLSTERED BACK TASK CHAIR

8. Packaging

Base and Color and Material	Code	Price	
Knocked Down	KD	+ \$0	
Back Attached to Seat, Base Separate	UC	+ \$80	
Fully Assembled in a Carton	AC	+ \$200	



SPECIFICATIONS

	5622 B4 Midback Mesh Task Chair	5623 B4 Highback Mesh Task Chair
Overall Width Armless	26"	26"
Overall Width With Arms	27.3"	27.5"
Overall Depth	25"	26"
Overall Height	35" (B0), 35.5" (B3/B8)	39" (B0), 39.5" (B3/B8)
Seat Width	19"	19"
Seat Depth	18.5"-20.75"	18.5"-20.75"
Seat Height	16.5"-20.125" (T) 17.5"-20.5" (K) 16.75"-20.75" (Y)	16.5"-20.125" (T) 17.5"-20.5" (K) 16.75"-20.75" (Y)
	16.88"-20.25" (Y) (B3/B8)	16.88"-20.25" (Y) (B3/B8)
Back Width	18.25"	18.3"
Back Height	20"	23.5"
Weight Armless	35.5 lb	36.5 lb
Weight With Arms	41.5 lb	42.5 lb
COM	1.15 yd	1.25 yd
COL	23 sq ft	25 sq ft
Weight Capacity Warranty	300 lb 350 lb (HD)	300 lb 350 lb (HD)

Swivel tilt mechanism (T). Knee tilt mechanism (K). Enhanced synchro mechanism (Y). High profile polished aluminum base (B3). High profile brushed aluminum base (B8). Heavy Duty (HD).

UPHOLSTERED BACK TASK CHAIR

SPECIFICATIONS

	5623 B1 LT Highback Mesh Large and Tall Task Chair
Overall Width Armless	26"
Overall Width With Arms	29"
Overall Depth	27.75"
Overall Height	38.5" (B7), 39.75" (B5)
Seat Width	22"
Seat Depth	17.5"
Seat Height	17.5"-21.5" (Y) (B7) 16.88"-20.25" (Y) (B5)
Back Width	18.3"
Back Height	21.5"
Weight Armless	47 lb
Weight With Arms	53 lb
COM	1.25 yd
COL	31 sq ft
Weight Capacity Warranty	400 lb

Enhanced synchro mechanism (Y). Heavy Duty black nylon base (B7). Heavy Duty polished aluminum base (B5).



Focus

UPHOLSTERED BACK TASK STOOL

Where comfort, style and ergonomics converge.

Experience something so comfortable it hardly ever crosses your mind—from the moment you sit down until it's time to head home. Our best-selling seating solution works just about anywhere you need thanks to a wider back frame, extra-deep seat and almost endless options to customize.

Our signature dual-curve frame takes its cues from modern, industrial design while also reinforcing key points of contact, so your back is optimally supported throughout the day. Plus, a built-in lumbar system helps promote correct posture so that you spend more time working and less time (re)adjusting your seat.



Featured Models

GOOD :: \$746

Midback upholstered, task stool, basic mechanism, armless, black nylon base, grade 1 textile

BETTER :: \$868

Highback upholstered, task stool, basic mechanism, height-adjustable arms, black nylon base, grade 1 textile

BEST :: \$967

Highback upholstered, task stool, adjustable lumbar support, basic mechanism, height-/width-adjustable arms, extended stool kit, black nylon base, grade 1 textile

Features

- Ergonomic back support and comfort
- Midback and highback
- Relaxed-fit upholstered pad
- Adjustable lumbar option
- Nine ergonomic arm styles with standard or Sport arm pads
- Black or silver accents
- Waterfall seatpage 203
- Optional Sport casters
- Complements Focus Side chair, counter and bar stool; see
- Standard 300 lb weight capacity warranty

1. Back

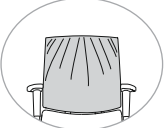
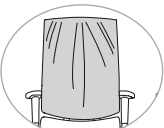
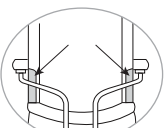
Back Size and Style	Code	Price	
Midback Relaxed-Fit Upholstered Pad	5622 B4	\$836	
Highback Relaxed-Fit Upholstered Pad	5623 B4	\$868	
Back Options	Code	Price	
Adjustable Lumbar Support	LB1	+ \$50	

UPHOLSTERED BACK TASK STOOL

2. Mechanism

Mechanism	Code	Price	
Basic (Swivel Only)	B	+\$0	

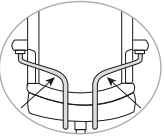

3. Frame

Back Support Color	Code	Price	
Black	Z1	+\$0	
Silver	Z2	+\$0	



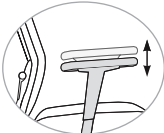
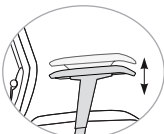
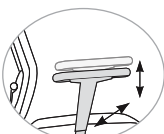
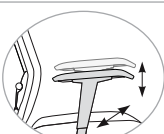
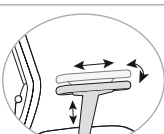
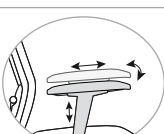
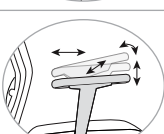
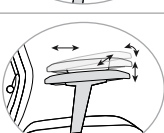

UPHOLSTERED BACK TASK STOOL

4. Arms

Arm Style	Code	Price	
Armless	A0	- \$90	
Fixed Arms	A91	- \$15	
Height-Adjustable	A92	+ \$0	
Height-Adjustable With Sport Arm Pads	A152	+ \$0	
Height-/Width-Adjustable	A93	+ \$25	
Height-/Width-Adjustable With Sport Arm Pads	A153	+ \$25	
Fully Adjustable (6-Way)	A94	+ \$56	
Fully Adjustable (6-Way) With Sport Arm Pads	A154	+ \$56	
Fully Multi-Adjustable (10-Way)	A95	+ \$66	
Fully Multi-Adjustable (10-Way) With Sport Arm Pads	A155	+ \$66	

Fixed arms (A91) are not available with the enhanced synchro (Y) mechanism.

5. Base

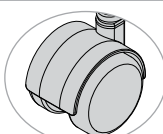
Base	Code	Price	
Stool Kit	S1	+ \$0	
Extended Stool Kit	S2	+ \$24	
Base Color and Material	Code	Price	
Black Nylon Base	B6	+ \$0	
Polished Aluminum Base	B5	+ \$167	
Casters or Glides	Code	Price	
Casters			
Carpet Casters	C5	+ \$0	
Carpet Casters (For Higher Cylinder Only)	C21	+ \$0	
Sport Carpet Casters	C31	+ \$0	
Sport Hard Floor and Carpet Casters	C32	+ \$40	
Hard Floor and Carpet Casters	C1	+ \$40	
Hard Floor and Carpet Casters (For Higher Cylinder Only)	C22	+ \$40	
Self-Locking Carpet Casters	C2	+ \$30	
Self-Locking Hard Floor and Carpet Casters	C7	+ \$61	
Glides			
Glides for Task Chairs	C3	+ \$30	

Self-locking casters (C2/C7) lock only when not in use.

6. Material

Protection	Code	Price	
CAL 133, Fabric, Quantities 1–49	133F	+ \$99	
CAL 133, Fabric, Quantities 50+	133F5	+ \$55	
CAL 133, Leather, Any Quantity	133L	+ \$119	
Seat and Back Textile	Code	Price	
COM	COM	+ \$0	
Fabric/Vinyl Grade 1	FG1/VG1	+ \$0	
Fabric/Vinyl Grade 2	FG2/VG2	+ \$34	
Fabric/Vinyl Grade 3	FG3/VG3	+ \$74	
Fabric/Vinyl Grade 4	FG4/VG4	+ \$121	
Fabric/Vinyl Grade 5	FG5/VG5	+ \$174	
Fabric/Vinyl Grade 6	FG6/VG6	+ \$235	
Fabric/Vinyl Grade 7	FG7/VG7	+ \$296	
COL	COL	+ \$260	
Leather Grade 1	LG1	+ \$260	
Leather Grade 2	LG2	+ \$320	
Leather Grade 3	LG3	+ \$400	

Please reference the *Textile Reference Guide* for pricing on fabric over grade 7 and leather over grade 3.

7. Packaging

Packaging	Code	Price	
Knocked Down	KD	+ \$0	
Back Attached to Seat, Base Separate	UC	+ \$80	
Fully Assembled in a Carton	AC	+ \$200	

UPHOLSTERED BACK TASK STOOL

MIDBACK SPECIFICATIONS

	5622 B4 S1 Midback Upholstered Task Stool	5622 B4 S2 Midback Upholstered Extended Task Stool
Overall Width Armless	27.3"	27.3"
Overall Width With Arms	27.3"	27.3"
Overall Depth	25"	25"
Overall Height	41.6"	46"
Seat Width	19"	19"
Seat Depth	18.5"	18.5"
Seat Height	21"–29"	24"–34"
Back Width	18.25"	18.25"
Back Height	20"	20"
Weight Armless	39.5 lb	40.5 lb
Weight With Arms	45.5 lb	46.5 lb
COM	1.15 yd	1.15 yd
COL	23 sq ft	23 sq ft
Weight Capacity	300 lb	300 lb

HIGHBACK SPECIFICATIONS

	5623 B4 S1 Highback Upholstered Task Stool	5623 B4 S2 Highback Upholstered Extended Task Stool
Overall Width Armless	20"	20"
Overall Width With Arms	27.5"	27.5"
Overall Depth	26"	26"
Overall Height	45"	50"
Seat Width	20"	20"
Seat Depth	18.5"	18.5"
Seat Height	21"–29"	24"–34"
Back Width	18.3"	18.3"
Back Height	23.5"	23.5"
Weight Armless	40.5 lb	41.5 lb
Weight With Arms	46.5 lb	47.5 lb
COM	1.15 yd	1.15 yd
COL	23 sq ft	23 sq ft
Weight Capacity	300 lb	300 lb

Focus 2.0

MESH BACK TASK CHAIR

Focus reimagined.

Focus™ 2.0 is more than a makeover. It's a modernization. It's driving dependable design forward with innovative mesh, enhanced (and expanded) customization, advanced functionality and a slimmer silhouette that offers superior comfort from integrated lumbar support and cutting-edge ergonomics. Focus 2.0 is everything you loved in the first generation and more.



Featured Models

GOOD :: \$586

Highback mesh with adjustable lumbar support, swivel-tilt mechanism, height-adjustable arms, black frame, black nylon Y-support, black nylon base, accent color, carpet casters, grade 1 textile

BETTER :: \$681

Highback mesh back with adjustable lumbar support, enhanced synchro mechanism, height-/width-adjustable (4-way) arms, black frame, black nylon Y-support, black nylon base, accent color, carpet casters, grade 1 textile

BEST :: \$855

Highback mesh with adjustable lumbar support, enhanced synchro mechanism with seat-depth adjustment, fully adjustable (8-way) arms, white frame, piano black Y-support, white nylon base, accent color, carpet casters, grade 1 textile

FOCUS 2.0

GSA SIN #: 33721

Features

- Slimmer, refined design
- Swivel-tilt and enhanced synchro mechanism
- Modernized Y-support customizable in four colors, including piano black
- Three frame and four base colors
- Armless, height-adjustable, height-/width-adjustable or fully adjustable arms
- 12 accent colors for pull handle stripe, lumbar casing, arm adjustment and caster rings
- Three exclusive mesh options in Focus mesh, Focus 2.0 mesh and Focus Uptown mesh
- Adjustable lumbar support included
- Performance casters color coordinate with frame and base
- Complements Focus Side chair, counter and bar stool; see page 203
- 300 lb weight capacity warranty

1. Back

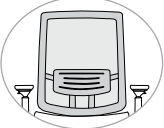

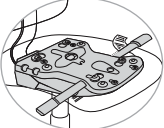
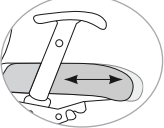

Back Size and Style	Code	Price	
Highback Mesh With Adjustable Lumbar	1123 BK2 MB	\$656	

2. Mechanism

Mechanism Style	Code	Price	
Swivel-Tilt	T	- \$70	
Enhanced Synchro	Y	+\$0	
Enhanced Synchro With Seat-Depth Adjustment	Y/E3	+ \$79	

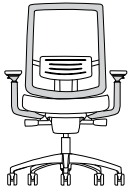
MESH BACK TASK CHAIR

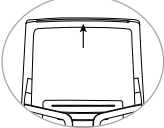
3. Frame

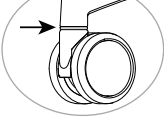
Frame Color	Code	Price	
Black	FC1	+\$0	
Fog	FC13	+\$35	
White	FC12	+\$35	
Y-Support Color	Code	Price	
Black	YCC01	+\$0	
White	YCC02	+\$0	
Fog	YCC03	+\$0	
Piano Black	YCC04	+\$25	
Accent Color	Code	Price	
Apple	LA12	+\$0	
Desert	LA3	+\$0	
Electric Blue	LA5	+\$0	
Fire	LA6	+\$0	
Fog	LA4	+\$0	
Graphite	LA14	+\$0	
Navy	LA15	+\$0	
Nickel	LA2	+\$0	
Ocean	LA10	+\$0	
Onyx	LA1	+\$0	
Tangerine	LA9	+\$0	
White	LA13	+\$0	

Due to the high-gloss material, the piano black Y-support (YCC04) is more susceptible to scratches and scuffs in a workstation environment and requires more care when removing protective packaging. Scratches and scuffs may not be covered under warranty.

Accent color is applied to pull handle stripe, lumbar casing, arm adjustment and caster rings.

FOCUS 2.0



GSA SIN #: 33721

4. Arms

Arm Style	Code	Price	
Armless	AR0	-\$48	
Height-Adjustable	AR4	+\$0	
Height-/Width-Adjustable (4-Way)	AR6	+\$25	
Fully Adjustable (8-Way)	AR9	+\$60	

Arms, if specified, come with fog arm pads for the white (FC12) and fog (FC13) frames and black arm pads for the black frame (FC1).

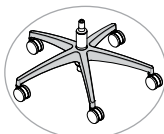
5. Base

Base Style	Code	Price	
5-Star Nylon	BT1	+\$0	
5-Star Polished Aluminum	BT2	+\$113	

Nylon Base Color	Code	Price	
Black Nylon Base	BC1	+\$0	
Fog Nylon Base	BC4	+\$0	
White Nylon Base	BC3	+\$0	

Cylinder Height	Code	Price	
Higher Cylinder	CH3	+\$0	
Standard Cylinder	CH1	+\$0	

MESH BACK TASK CHAIR

5. Base (Cont.)

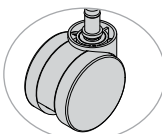
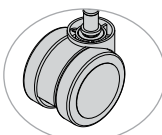
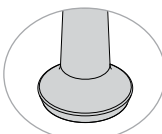
Casters or Glides	Code	Price	
Casters			
Carpet Casters	CS5	+\$0	
Hard Floor and Carpet Casters	CS6	+\$40	
Glides			
Glides for Task Chairs	CS3	+\$30	

6. Material

Mesh	Code	Price	
Focus 2.0 Mesh			
Apple	MC31	+\$0	
Desert	MC9	+\$0	
Electric Blue	MC13	+\$0	
Fire	MC10	+\$0	
Fog	MC7	+\$0	
Navy	MC8	+\$0	
Nickel	MC6	+\$0	
Ocean	MC29	+\$0	
Onyx	MC5	+\$0	
Tangerine	MC28	+\$0	
Focus 2.0 Uptown Mesh			
Midnight	MC43	+\$0	
Charcoal	MC44	+\$0	
Ash	MC45	+\$0	
Dune	MC46	+\$0	
Focus Mesh			
Black	MC1	+\$0	
Sand	MC3	+\$0	
Slate	MC2	+\$0	
Freeway Sport Stripe (Black/Slate)	MC33	+\$0	
Impress Sport Stripe (Slate/Black)	MC34	+\$0	

Sport striped meshes list the predominant color first.

FOCUS 2.0

GSA SIN #: 33721

6. Material (Cont.)

Seat Textile	Code	Price	
COM	COM	+\$0	
Fabric/Vinyl Grade 1	FG1/VG1	+\$0	
Fabric/Vinyl Grade 2	FG2/VG2	+\$26	
Fabric/Vinyl Grade 3	FG3/VG3	+\$60	
Fabric/Vinyl Grade 4	FG4/VG4	+\$116	
Fabric/Vinyl Grade 5	FG5/VG5	+\$172	
Fabric/Vinyl Grade 6	FG6/VG6	+\$213	
Fabric/Vinyl Grade 7	FG7/VG7	+\$254	
COL	COL	+\$300	
Leather Grade 1	LG1	+\$300	
Leather Grade 2	LG2	+\$380	
Leather Grade 3	LG3	+\$480	

Please reference the *Textile Reference Guide* for pricing on fabric over grade 7 and leather over grade 3.

7. Packaging

Mesh	Code	Price	
Knocked Down	KD	+\$0	
Back Attached to Seat, Base Separate	UC	+ \$80	
Fully Assembled in a Carton	AC	+ \$200	

MESH BACK TASK CHAIR

SPECIFICATIONS

	1123 BK2 MB Highback Mesh Task Chair
Overall Width Without Arms	26"
Overall Width With Arms	28.5"
Overall Depth	28.5"
Overall Height	38.8"-42.6"
Seat Width	19.6"
Seat Depth	16.3"-19.1"
Seat Height	16.6"-20.1" (T) 16.9"-20.4" (Y)
Seat Height With Higher Cylinder	17.1"-22.3" (T) 17.4"-22.6" (Y)
Back Width	18.6"
Back Height	23.6"
Weight Armless	38.7 lb
Weight With Arms	43.5 lb
COM	1 yd
COL	14 sq ft
Weight Capacity Warranty	300 lb

Swivel-tilt mechanism (T). Enhanced synchro mechanism (Y).



Better

Glove Active

CONFERENCE CHAIR

The lap of luxury.

The Glove™ Active is a luxurious leadership chair that combines pillow-top padding with classic tufted leather seating. It boasts an abundance of foam padding and folds of leather. Available with four mechanism choices, four adjustable arm styles, and optional seat-depth adjustment, Glove Active raises the bar for flexibility and control. It's a luxurious choice for guest and task seating in an executive suite, boardroom or behind a manager's desk.



Better

Featured Models

GOOD :: \$1,255

Midback, swivel-tilt mechanism, loop arms, nylon base, grade 1 leather

BETTER :: \$1,692

Highback, enhanced synchro mechanism, height-adjustable arms, nylon base, grade 2 leather

BEST :: \$1,965

Highback, multi-function mechanism with seat depth adjustment, height-/width-adjustable arms with pivot, brushed aluminum base, grade 2 leather

GLOVE ACTIVE

GSA SIN #: 33721

Features

- Pillow top
- Midback or highback
- Waterfall seat
- 250 lb weight capacity warranty;
350 lb Heavy Duty weight capacity warranty

1. Back

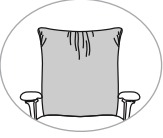
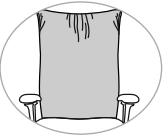
Back Size and Style	Code	Price	
Midback	7531	\$1,120	
Highback	7532	\$1,152	

2. Heavy Duty

Heavy Duty Series	Code	Price	
Heavy Duty	HD	+ \$126	

Heavy duty option not available with swivel-tilt (T) mechanism. See page 38 for additional LT and HD options.

CONFERENCE CHAIR

3. Mechanism

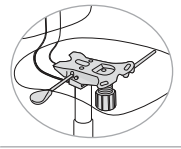
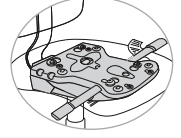
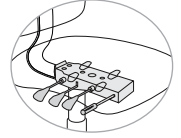
Mechanism	Code	Price	
Swivel-Tilt	T	- \$90	
Enhanced Synchro	Y	+ \$0	
Multi-Function	M	+ \$36	

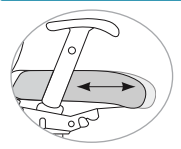
Seat-Depth Adjustment	Code	Price	
Seat-Depth Adjustment	E3	+ \$79	

Seat-depth adjustment not available with swivel-tilt (T) mechanism.



Good

GLOVE ACTIVE



GSA SIN #: 33721

4. Arms

Arm Style	Code	Price	
Armless	A0	- \$90	
Fixed Loop	A26	- \$15	
Height-Adjustable	A27-L	+ \$0	
Height-Adjustable With Pivot	A27	+ \$10	
Height-/Width-Adjustable	A28-L	+ \$25	
Height-/Width-Adjustable With Pivot	A28	+ \$45	
Upholstered Cap Loop	A41	+ \$93	

Heavy Duty (HD) option not available with fixed loop arms (A26) or upholstered cap loop arms (A41).

5. Base

Base Color and Material	Code	Price	
Black Nylon Base	B0	+ \$0	
Heavy Duty Black Nylon Base, 26" (For HD)	B7	+ \$0	
Brushed Aluminum Base	B2	+ \$113	

Aluminum base (B2) not available with seat-depth adjustment (E3).

CONFERENCE CHAIR

5. Base (Cont.)

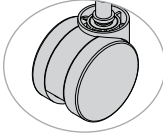
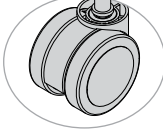
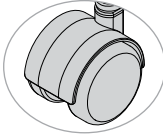
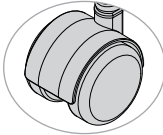
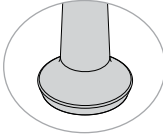
Casters or Glides	Code	Price	
Casters			
Black Carpet Casters	C11	+ \$0	
Black Hard Floor and Carpet Casters	C9	+ \$40	
Self-Locking Carpet Casters	C2	+ \$30	
Self-Locking Hard Floor and Carpet Casters	C7	+ \$61	
Glides			
Glides for Task Chairs	C3	+ \$30	

Self-locking casters (C2/C7) lock only when not in use. Self-locking casters not available for Heavy Duty series.

6. Material

Protection	Code	Price	
CAL 133, Fabric, Quantities 1-49	133F	+ \$99	
CAL 133, Fabric, Quantities 50+	133F5	+ \$55	
CAL 133, Leather, Any Quantity	133L	+ \$119	
Ballistic Nylon			
Ballistic Nylon Back	BN	+ \$0	
None	N	+ \$0	

GLOVE ACTIVE

GSA SIN #: 33721

6. Material (Cont.)

Seat and Back Textile	Code	Price
COM	COL	+ \$0
Fabric/Vinyl Grade 1	FG1/VG1	+ \$0
Fabric/Vinyl Grade 2	FG2/VG2	+ \$40
Fabric/Vinyl Grade 3	FG3/VG3	+ \$84
Fabric/Vinyl Grade 4	FG4/VG4	+ \$156
Fabric/Vinyl Grade 5	FG5/VG5	+ \$228
Fabric/Vinyl Grade 6	FG6/VG6	+ \$304
Fabric/Vinyl Grade 7	FG7/VG7	+ \$378
COL	COL	+ \$240
Leather Grade 1	LG1	+ \$240
Leather Grade 2	LG2	+ \$540
Leather Grade 3	LG3	+ \$820
Leather/Ballistic Grade 2	BN2	+ \$379
Leather/Ballistic Grade 3	BN3	+ \$631

Please reference the *Textile Reference Guide* for pricing on fabric over grade 7 and leather over grade 3.

Note: Due to the alignment between chair panels, the chairs ordered in a textile will ship with a black spacer mesh outer back. Chairs ordered in vinyl or leather ship fully upholstered in the finish selected.

7. Packaging

Packaging	Code	Price
Back Attached to Seat, Base Separate	UC	+ \$0
Fully Assembled in a Carton	AC	+ \$120

CONFERENCE CHAIR

SPECIFICATIONS

	7531 Midback Chair	7532 Highback Chair
Overall Width	27.75"	27.75"
Overall Depth	25"	25"
Overall Height	40" (T) 40.5 (Y/M)	43" (T) 43.5 (Y/M)
With Aluminum Base	40.5" (T/B2) 41" (Y/M/B2)	43.5" (T/B2) 44" (Y/M/B2)
Seat Width	19.75"	19.75"
Seat Depth	17"	18"
Seat Height	16.25"-20.75" (T) 16.5"-20" (Y) 16.5"-21" (M)	16.25"-20.75" (T) 16.5"-20" (Y) 16.5"-21" (M)
With Aluminum Base	16.75"-21.25" (T) (B2) 17"-20.5" (Y) (B2) 17"-21.5" (M) (B2)	16.75"-21.25" (T) (B2) 17"-20.5" (Y) (B2) 17"-21.5" (M) (B2)
Back Width	23"	23"
Back Height	19.5"	22.5"
Weight	56 lb (T) 63 lb (Y) 64 lb (M)	59 lb (T) 66 lb (Y) 67 lb (M)
COM	2.4 yd 1.25 yd (BN)	2.5 yd 1.4 yd (BN)
COL	50 sq ft 36 sq ft (BN)	55 sq ft 42 sq ft (BN)
Weight Capacity Warranty	250 lb 350 lb (HD)	250 lb 350 lb (HD)

Swivel-tilt mechanism (T). Enhanced synchro mechanism (Y). Heavy duty (HD). Multi-function mechanism (M). Ballistic nylon back (BN). Brushed aluminum base (B2)

Glove Executive

CONFERENCE CHAIR

The lap of luxury.

The Glove™ Executive is a luxurious leadership chair that combines pillow-top padding with classic tufted leather seating. Boasting an abundance of foam padding and folds of leather, Glove is the seat of comfort for the head of a boardroom conference table or the corner office.



Best

Featured Models

GOOD :: \$1,411

Midback, swivel-tilt mechanism, loop arms, nylon base, grade 1 leather

BETTER :: \$1,444

Midback, knee-tilt mechanism, loop arms, nylon base, grade 1 leather

BEST :: \$1,997

Highback, knee-tilt mechanism, upholstered cap loop arms, brushed aluminum base, grade 2 leather

GLOVE EXECUTIVE

GSA SIN #: 33721

Features

- Pillow top
- Midback or highback
- Optional button detail
- Waterfall seat
- 250 lb weight capacity warranty;
350 lb Heavy Duty weight capacity warranty

1. Back

Back Size and Style	Code	Price	
---------------------	------	-------	--

Midback	7541	\$1,204	
---------	------	---------	---

Highback	7542	\$1,236	
----------	------	---------	---

Back Options	Code	Price	
--------------	------	-------	--

Remove Button	RB	+\$0	
---------------	----	------	---

2. Mechanism

Mechanism	Code	Price	
-----------	------	-------	--

Swivel-Tilt	T	-\$33	
-------------	---	-------	---

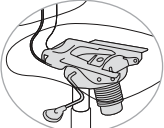
Knee-Tilt	K	+\$0	
-----------	---	------	---

CONFERENCE CHAIR

3. Arms

Arm Style	Code	Price	
-----------	------	-------	--

Fixed Loop	A26	+\$0	
------------	-----	------	---

Upholstered Cap Loop	A41	+\$108	
----------------------	-----	--------	---

4. Base

Base Color and Material	Code	Price	
-------------------------	------	-------	--

Black Nylon Base	B0	+\$0	
------------------	----	------	---

Brushed Aluminum Base	B2	+\$113	
-----------------------	----	--------	--

Casters or Glides	Code	Price	
-------------------	------	-------	--

Casters

Carpet Casters	C5	+\$0	
Black Carpet Casters (For Brushed Aluminum Base B2)	C11	+\$0	

Hard Floor and Carpet Casters	C1	+\$40	
Black Hard Floor and Carpet Casters (For Brushed Aluminum Base B2)	C9	+\$61	

Self-Locking Carpet Casters	C2	+\$30	
--------------------------------	----	-------	---

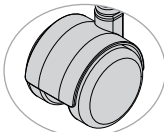
Self-Locking Hard Floor and Carpet Casters	C7	+\$61	
---	----	-------	---

Self-locking casters (C2/C7) lock only when not in use.

GLOVE EXECUTIVE

GSA SIN #: 33721

4. Base (Cont.)

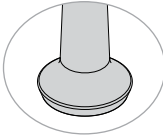
Casters or Glides	Code	Price	
Glides			
Glides for Task Chairs	C3	+ \$30	

5. Material

Protection	Code	Price	
CAL 133, Fabric, Quantities 1-49	133F	+ \$99	
CAL 133, Fabric, Quantities 50+	133F5	+ \$55	
CAL 133, Leather, Any Quantity	133L	+ \$119	
Ballistic Nylon Back	Code	Price	
Ballistic Nylon Back	BN	+ \$0	
None	N	+ \$0	
Seat and Back Textile	Code	Price	
COM	COM	+ \$0	
Fabric/Vinyl Grade 1	FG1/VG1	+ \$0	
Fabric/Vinyl Grade 2	FG2/VG2	+ \$40	
Fabric/Vinyl Grade 3	FG3/VG3	+ \$84	
Fabric/Vinyl Grade 4	FG4/VG4	+ \$156	
Fabric/Vinyl Grade 5	FG5/VG5	+ \$228	
Fabric/Vinyl Grade 6	FG6/VG6	+ \$304	
Fabric/Vinyl Grade 7	FG7/VG7	+ \$378	
COL	COL	+ \$240	
Leather Grade 1	LG1	+ \$240	
Leather Grade 2	LG2	+ \$540	
Leather Grade 3	LG3	+ \$820	
Leather/Ballistic Grade 2	BN2	+ \$379	
Leather/Ballistic Grade 3	BN3	+ \$631	

Please reference the *Textile Reference Guide* for pricing on fabric over grade 7 and leather over grade 3.

Note: Due to the alignment between chair panels, the chairs ordered in a textile will ship with a black spacer mesh outer back. Chairs ordered in vinyl or leather ship fully upholstered in the finish selected.

6. Packaging

Packaging	Code	Price	
Back Attached to Seat, Base Separate	UC	+ \$0	

CONFERENCE CHAIR

SPECIFICATIONS

	7541 Midback Conference Chair	7542 Highback Conference Chair
Overall Width	24.5"	24.5"
Overall Depth	27"	27"
Overall Height	42" (B0) 42.5" (B2)	48" (B0) 48.5" (B2)
Seat Width	20.5"	20.5"
Seat Depth	20"	20"
Seat Height With Aluminum Base	16.5"-21" (B0) 17"-21.5" (B2)	16.5"-21" (B0) 17"-21.5" (B2)
Back Width	22.75"	22.75"
Back Height	21"	27"
Weight	61 lb (T) 64 lb (K)	69 lb (T) 72 lb (K)
COM	3.25 yd 2.15 yd (BN)	3.5 yd 2.35 yd (BN)
COL	56 sq ft 44 sq ft (BN)	70 sq ft 57 sq ft (BN)
Weight Capacity	250 lb	250 lb

Swivel-tilt mechanism (T). Knee-tilt mechanism (K). Ballistic nylon back (BN). Black nylon base (B0) Brushed aluminum base (B2)



Good

InFlex

LIGHT TASK CHAIR AND TASK STOOL

Geometry in motion.

The InFlex™ light task chair and stool deliver task functionality with fun styling. Designer Giancarlo Piretti fused design and engineering to create the flexback disc system that follows the spine's natural curve. A stylish, comfortable and affordable standout in a creative office space or anywhere collaboration is called for.



Featured Models

GOOD :: \$408

All plastic seat and back, basic mechanism, armless, carpet casters

BETTER :: \$466

Plastic back, upholstered seat, basic mechanism, armless, carpet casters, grade 1 textile



BEST :: \$582

Upholstered seat and back, basic mechanism, fixed task arms, carpet casters, grade 1 textile

Features

- Giancarlo Piretti design
- Innovative disc system emulates the human spine
- Fully upholstered, upholstered seat or plastic
- 14 plastic colors
- Two frame finishes
- CAL 133 approved models
- 300 lb weight capacity warranty
- Complements InFlex multipurpose chair, counter and bar stool; see page 220

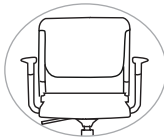
1. Back

Back and Seat Style	Code	Price	
Plastic	No Code	\$408	
Upholstered Seat	US	\$466	
Upholstered Seat and Back	UP	\$524	

LIGHT TASK CHAIR AND TASK STOOL

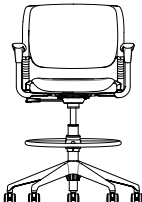
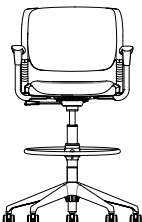

2. Frame

Frame Type	Code	Price	
Task Chair	973B	+ \$0	
Task Stool	973B S1	+ \$132	
Extended Task Stool	973B S2	+ \$156	

Frame Finish	Code	Price	
Black	FC1	+ \$0	
Silver	FC2	+ \$0	

InFlex task models come with basic mechanism (swivel only).

3. Arms

Arm Style	Code	Price	
Armless	A0	+ \$0	
Fixed Task Arms	A122	+ \$58	

4. Base

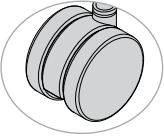
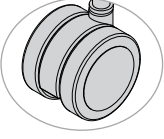
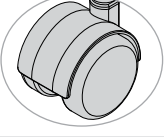
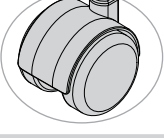
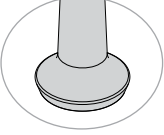
Casters or Glides	Code	Price	
Casters			
Carpet Casters	C15	+ \$0	
Hard Floor and Carpet Casters	C14	+ \$40	
Self-Locking Carpet Casters	C20	+ \$30	
Self-Locking Hard Floor and Carpet Casters	C19	+ \$64	
Glides			
Glides for Task Chairs	C3	+ \$30	

Self-locking casters (C19/C20) lock only when not in use.

LIGHT TASK CHAIR AND TASK STOOL

5. Material

Protection	Code	Price	
CAL 133, Fabric, Quantities 1-49	133F	+ \$99	
CAL 133, Fabric, Quantities 50+	133F5	+ \$55	
CAL 133, Plastic, Any Quantity	133P	+ \$45	
Shell Color	Code	Price	
Apple	SC24	+ \$0	
Arctic	SC21	+ \$0	
Black	SC1	+ \$0	
Bisque	SC7	+ \$0	
Chocolate	SC4	+ \$0	
Lagoon	SC15	+ \$0	
Latte	SC20	+ \$0	
Lemon	SC25	+ \$0	
Navy	SC5	+ \$0	
Pacific	SC22	+ \$0	
Red	SC19	+ \$0	
Slate	SC8	+ \$0	
Sterling	SC18	+ \$0	
Tangerine	SC23	+ \$0	
Textile	Code	Price	
Seat Textile Only (For US)			
COM	COM	+ \$0	
Fabric/Vinyl Grade 1	FG1/VG1	+ \$0	
Fabric/Vinyl Grade 2	FG2/VG2	+ \$22	
Fabric/Vinyl Grade 3	FG3/VG3	+ \$45	
Fabric/Vinyl Grade 4	FG4/VG4	+ \$77	
Fabric/Vinyl Grade 5	FG5/VG5	+ \$116	
Fabric/Vinyl Grade 6	FG6/VG6	+ \$159	
Fabric/Vinyl Grade 7	FG7/VG7	+ \$200	
Seat and Back Textile (For UP)			
COM	COM	+ \$0	
Fabric/Vinyl Grade 1	FG1/VG1	+ \$0	
Fabric/Vinyl Grade 2	FG2/VG2	+ \$34	
Fabric/Vinyl Grade 3	FG3/VG3	+ \$74	
Fabric/Vinyl Grade 4	FG4/VG4	+ \$121	
Fabric/Vinyl Grade 5	FG5/VG5	+ \$174	
Fabric/Vinyl Grade 6	FG6/VG6	+ \$235	
Fabric/Vinyl Grade 7	FG7/VG7	+ \$296	

Please reference the Textile Reference Guide for pricing on fabric over grade 7.

6. Packaging

Packaging	Code	Price
Back Attached to Seat, Base Separate	UC	+ \$0

SPECIFICATIONS

	973B Task Chair	973B S1 Task Stool	973B S2 Extended Task Stool
Overall Width Armless	19.75"	19.75"	19.75"
Overall Width With Arms	25"	25"	25"
Overall Depth	22.25"	22.25"	22.25"
Overall Height	32.5"	38.5"	42.5"
Seat Width	16.75"	16.75"	16.75"
Seat Depth	18.5"	18.5"	18.5"
Seat Height	16.5"-21.5"	20"-28"	24.5"-34.5"
Back Width	19.75"	19.75"	19.75"
Back Height	15.5"	15.5"	15.5"
Weight Armless	15 lb	16.5 lb	16.5 lb
Weight With Arms	19 lb	20.5 lb	20.5 lb
COM	0.85 yd (US) 1 yd (UP)	0.85 yd (US) 1 yd (UP)	0.85 yd (US) 1 yd (UP)
COL	10 sq ft (US) 15 sq ft (UP)	10 sq ft (US) 15 sq ft (UP)	10 sq ft (US) 15 sq ft (UP)
Weight Capacity Warranty	300 lb	300 lb	300 lb

Upholstered seat only (US). Upholstered seat and back (UP).



Ioniq

COLLABORATIVE CHAIR

Inspire unique.

There's a specialness that flows through Ioniq™. Its form and feeling are fluid—from the way the arms stretch seamlessly out of a sculpted shell to base options that are as varied and versatile as the spaces they occupy. Because when you desire aesthetics that elevate any experience and offer something refreshingly different, there's only one go-to. And that's Ioniq.



Featured Models

GOOD :: \$665

Plastic back, upholstered seat, integrated arms, height-adjustable mechanism with swivel and tilt, 5-star nylon base, carpet casters, grade 1 textile

BETTER :: \$778

Plastic back, upholstered seat, integrated arms, height-adjustable mechanism with swivel and tilt, 5-star polished aluminum, carpet casters, grade 1 textile

Features

- Breathable back with built-in lumbar support
- Minimalist-designed mechanism with streamlined controls
- Edge-to-edge cushion
- Fully integrated armrests
- Single-piece sculpted shell
- 5-star base
- Performance casters
- 300 lb weight capacity warranty
- Complements Ioniq Guest and Ioniq Side; see page 220 and page 222

1. Frame

Frame Type	Code	Price	
------------	------	-------	--

Collaborative Task
(5-Star Base)

1152 FT3

\$665



Seat and Back Style	Code	Price	
---------------------	------	-------	--

Plastic Back With
Upholstered Seat Pad

US PB

+ \$0

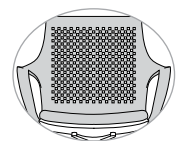

Shell Color	Code	Price	
-------------	------	-------	--

Black

SC1

+ \$0

White

SC26

+ \$0

2. Base

Base Type and Material	Code	Price	
------------------------	------	-------	--

5-Star Nylon

BT1

+ \$0

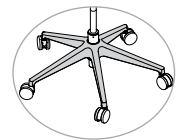

5-Star Polished Aluminum

BT2

+ \$113

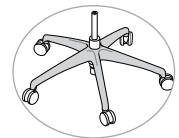

2. Base (Cont.)

Base Color	Code	Price	
------------	------	-------	--

Black Nylon Base

BC1

+ \$0

White Nylon Base

BC3

+ \$0

Casters or Glides	Code	Price	
-------------------	------	-------	--

Carpet Casters

CS5

+ \$0

Hard Floor and
Carpet Casters

CS6

+ \$40

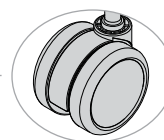

Black nylon base (BC1) available with black shell (SC1) only. White nylon base (BC3) available with white shell (SC26) only.

Caster color will correspond to shell color.

3. Mechanism

Mechanism	Code	Price	
-----------	------	-------	--

Height-Adjustable With
Swivel and Tilt

T

+ \$0

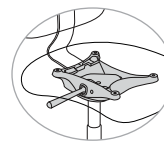

4. Material

Seat Textile	Code	Price	
--------------	------	-------	--

COM

COM

+ \$0

Fabric/Vinyl Grade 1

FG1/VG1

+ \$0

Fabric/Vinyl Grade 2

FG2/VG2

+ \$22

Fabric/Vinyl Grade 3

FG3/VG3

+ \$45

Fabric/Vinyl Grade 4

FG4/VG4

+ \$77

Fabric/Vinyl Grade 5

FG5/VG5

+ \$116

Fabric/Vinyl Grade 6

FG6/VG6

+ \$159

Fabric/Vinyl Grade 7

FG7/VG7

+ \$200

COL

COL

+ \$140

Leather Grade 1

LG1

+ \$140

Leather Grade 2

LG2

+ \$200

Leather Grade 3

LG3

+ \$280

Please reference the Textile Reference Guide for pricing on fabric over grade 7 and leather over grade 3.

5. Packaging

Packaging	Code	Price
Back Attached to Seat, Base Separate	UC	+ \$0
Fully Assembled in a Carton	AC	+ \$120

SPECIFICATIONS

	1152 FT3 Collaborative Chair
Overall Width	28"
Overall Depth	28"
Overall Height	33.75"-37.5"
Seat Width	20"
Seat Depth	17.38"
Seat Height	17.5"-21.25"
Back Width	18"
Back Height	17.38"
Weight	18.5 lb
COM	0.75 yd
COL	7 sq ft
Weight Capacity Warranty	300 lb

Chair is widest at the base.



Knack

TASK CHAIR

Smart choice. Everyday.

Knack™ boasts an uncluttered and traditional design that makes it an essential and affordable choice for corporate, healthcare, government and educational settings. The soft, comfortable back follows the natural curve of the spine, providing great support for hours of sitting. Five control selections and a Heavy Duty 24/7 option make Knack a great all-around task chair. Knack includes a back-height adjustment so every user can enjoy individualized upper-back and lumbar support.



Featured Models

GOOD :: \$564

Swivel-tilt mechanism, height-adjustable arms, nylon base, grade 1 textile

BETTER :: \$654

Enhanced synchro mechanism, height-adjustable arms, nylon base, grade 1 textile

BEST :: \$758

Enhanced synchro mechanism, height-/width-adjustable arms, seat-depth adjustment, nylon base, grade 1 textile

Features

- Durable and ergonomic
- Internal back-height adjustment (on Y and M mechanisms only)
- Ballistic nylon back (optional)
- Brushed aluminum, polished aluminum or nylon base
- Waterfall seat
- 300 lb weight capacity warranty;
350 lb Heavy Duty weight capacity warranty

1. Back

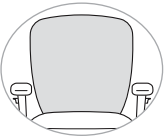
Back Size and Style	Code	Price	
Midback Task Chair	3323	\$654	



2. Heavy Duty

Heavy Duty Series	Code	Price	
Heavy Duty	HD	+ \$126	

Must select multi-function (M) or enhanced synchro (Y) mechanism. Not available with fixed loop (A77) arm. See page 38 for additional LT and HD options.

UPHOLSTERED BACK TASK CHAIR

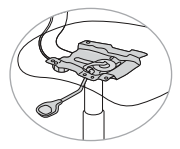
3. Mechanism

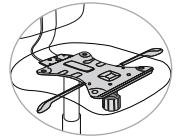
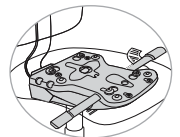
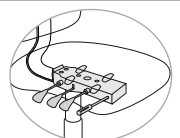
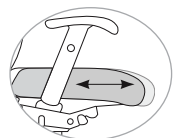
Mechanism	Code	Price	
Basic (Swivel Only)	B	- \$127	
Swivel-Tilt	T	- \$90	
Standard Synchro	F	- \$57	
Enhanced Synchro	Y	+ \$0	
Multi-Function	M	+ \$36	
Seat-Depth Adjustment	Code	Price	
Seat-Depth Adjustment	E3	+ \$79	

Seat-depth adjustment (E3) only available with multi-function (M) or enhanced synchro (Y) mechanism.

4. Arms

Arm Style	Code	Price	
Armless	A0	- \$90	
Fixed Loop	A77	- \$15	
Height-Adjustable	A80	+ \$0	
Height-/Width-Adjustable	A81	+ \$25	

5. Base

Base Color and Material	Code	Price	
Black Nylon Base	B0	+ \$0	
Black Nylon Base, 26"	B7	+ \$0	
Brushed Aluminum Base	B2	+ \$113	
Polished Aluminum Base	B5	+ \$167	

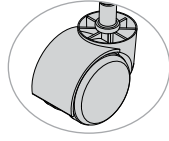
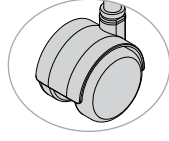
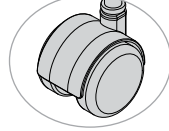
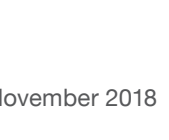
Casters or Glides	Code	Price	
Casters			
Carpet Casters	C5	+ \$0	
Hard Floor and Carpet Casters	C1	+ \$40	
Self-Locking Carpet Casters	C2	+ \$30	
Self-Locking Hard Floor and Carpet Casters	C7	+ \$61	

UPHOLSTERED BACK TASK CHAIR

5. Base (Cont.)

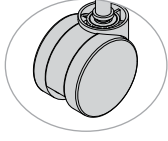
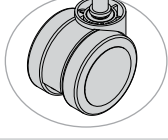
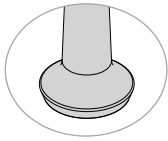
Casters or Glides	Code	Price	
Heavy Duty Casters			
Heavy Duty Carpet Casters	C11	+ \$30	
Heavy Duty Hard Floor and Carpet Casters	C9	+ \$61	
Glides			
Glides for Task Chairs	C3	+ \$30	

Black nylon base (B0) and polished aluminum base (B5) are not available for Heavy Duty (HD) option.

Self-locking casters (C2/C7) lock only when not in use.

6. Material

Protection	Code	Price	
CAL 133, Fabric, Quantities 1-49	133F	+ \$99	
CAL 133, Fabric, Quantities 50+	133F5	+ \$55	
CAL 133, Leather, Any Quantity	133L	+ \$119	
Ballistic Nylon Back			
Ballistic Nylon Back	BN	+ \$0	
Seat and Back Textile			
COM	COM	+ \$0	
Fabric/Vinyl Grade 1	FG1/VG1	+ \$0	
Fabric/Vinyl Grade 2	FG2/VG2	+ \$34	
Fabric/Vinyl Grade 3	FG3/VG3	+ \$74	
Fabric/Vinyl Grade 4	FG4/VG4	+ \$121	
Fabric/Vinyl Grade 5	FG5/VG5	+ \$174	
Fabric/Vinyl Grade 6	FG6/VG6	+ \$235	
Fabric/Vinyl Grade 7	FG7/VG7	+ \$296	
COL	COL	+ \$260	
Leather Grade 1	LG1	+ \$260	
Leather Grade 2	LG2	+ \$320	
Leather Grade 3	LG3	+ \$400	

Please reference the Textile Reference Guide for pricing on fabric over grade 7 and leather over grade 3.

7. Packaging

Packaging	Code	Price
Knocked Down	KD	+ \$0
Back Attached to Seat, Base Separate	UC	+ \$80
Fully Assembled in a Carton	AC	+ \$200



Good

UPHOLSTERED BACK TASK CHAIR

SPECIFICATIONS

	3323 Midback Task Chair
Overall Width	26"
Overall Depth	26"
Overall Height	34.5" (T/F) 35.5" (Y/M)
With Aluminum Base	35" (T/F) (B2) 36" (Y/M) (B2)
Seat Width	20.5"
Seat Depth	18"
Seat Height	16.5"-21" (T/F/M) 17.5"-22" (Y)
	17"-21.5" (T/F/M) (B2/B5) 18"-22.5" (Y) (B2/B5)
Back Width	20"
Back Height	19.5"
Weight Armless	39 lb
Weight With Arms	45 lb
COM	1.85 yd 1.55 yd (BN)
COL	32 sq ft 27 sq ft (BN)
Weight Capacity Warranty	300 lb 350 lb (M/Y)(HD)

Swivel-tilt mechanism (T). Standard synchro mechanism (F). Enhanced synchro mechanism (Y). Multi-function mechanism (M). Brushed aluminum base (B2). Polished aluminum base (B5).

Knack

TASK STOOL

Smart choice. Everyday.

Knack™ boasts an uncluttered and traditional design that makes it an essential and affordable choice for corporate, healthcare, government and educational settings. The soft, comfortable back follows the natural curve of the spine, providing great support for hours of sitting. The Knack stool comes with three arm options and choice of standard black or polished aluminum base.



Best

Featured Models

GOOD :: \$613

Midback stool, basic mechanism, armless, standard stool kit, black nylon base, carpet casters, grade 1 textile

BETTER :: \$703

Midback stool, basic mechanism, height-adjustable arms, standard stool kit, black nylon base, carpet casters, grade 1 textile

BEST :: \$752

Midback stool, basic mechanism, height-/width-adjustable arms, extended stool kit, black nylon base, carpet casters, grade 1 textile



Features

- Durable and ergonomic
- Internal back-height adjustment (on Y and M mechanisms only)
- Ballistic nylon back (optional)
- Black nylon or polished aluminum base
- Waterfall seat
- 300 lb weight capacity

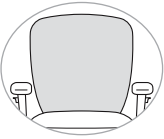
1. Back

Back Size and Style	Code	Price	
Midback Task Stool With Basic Mechanism (Swivel Only)	3323B	\$703	

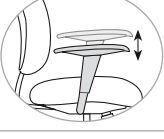
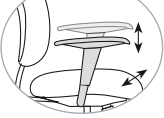

2. Arms

Arm Style	Code	Price	
Armless	A0	- \$90	
Fixed Loop	A77	- \$15	
Height-Adjustable	A80	+ \$0	
Height-/Width-Adjustable	A81	+ \$25	

UPHOLSTERED BACK TASK STOOL

3. Base

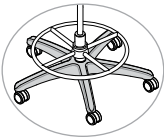
Base	Code	Price	
Stool Kit	S1	+ \$0	
Extended Stool Kit	S2	+ \$24	

Base Color and Material	Code	Price	
Black Nylon Base	B0	+ \$0	
Polished Aluminum Base	B2	+ \$167	

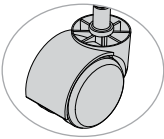
Casters or Glides	Code	Price	
Carpet Casters	C5	+ \$0	
Hard Floor and Carpet Casters	C1	+ \$40	

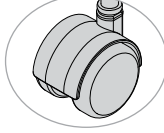
Self-Locking Carpet Casters	C2	+ \$30	
-----------------------------	----	--------	---

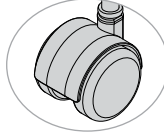
Self-Locking Hard Floor and Carpet Casters	C7	+ \$61	
--	----	--------	---

Heavy Duty Casters

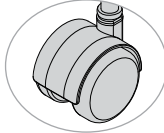
Heavy Duty Carpet Casters	C11	+ \$30	
---------------------------	-----	--------	---

Heavy Duty Hard Floor and Carpet Casters	C9	+ \$61	
--	----	--------	---

Glides

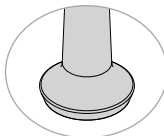
Glides for Task Chairs	C3	+ \$30	
------------------------	----	--------	---

Self-locking casters (C2/C7) lock only when not in use.

4. Material

Protection	Code	Price
CAL 133, Fabric, Quantities 1-49	133F	+ \$99
CAL 133, Fabric, Quantities 50+	133F5	+ \$55
CAL 133, Leather, Any Quantity	133L	+ \$119
Ballistic Nylon Back	Code	Price
Ballistic Nylon Back	BN	+ \$0
Seat and Back Textile	Code	Price
COM	COM	+ \$0
Fabric/Vinyl Grade 1	FG1/VG1	+ \$0
Fabric/Vinyl Grade 2	FG2/VG2	+ \$34
Fabric/Vinyl Grade 3	FG3/VG3	+ \$74
Fabric/Vinyl Grade 4	FG4/VG4	+ \$121
Fabric/Vinyl Grade 5	FG5/VG5	+ \$174
Fabric/Vinyl Grade 6	FG6/VG6	+ \$235
Fabric/Vinyl Grade 7	FG7/VG7	+ \$296
COL	COL	+ \$260
Leather Grade 1	LG1	+ \$260
Leather Grade 2	LG2	+ \$320
Leather Grade 3	LG3	+ \$400

Please reference the *Textile Reference Guide* for pricing on fabric over grade 7 and leather over grade 3.

5. Packaging

Packaging	Code	Price
Knocked Down	KD	+ \$0
Back Attached to Seat, Base Separate	UC	+ \$80
Fully Assembled in a Carton	AC	+ \$200

SPECIFICATIONS

	3323 S1 Midback Task Stool	3323 S2 Extended Midback Task Stool
Overall Width	27"	27"
Overall Depth	26.5"	26.5"
Overall Height With Aluminum Base	44" 44.5" (B5)	44" 44.5" (B5)
Seat Width	21.5"	21.5"
Seat Depth	18"	18"
Seat Height With Aluminum Base	19.5"-27.5" 20"-28"(B2)	23.5"-33.5" 24"-34" (B2)
Back Width	20.5"	20.5"
Back Height	19.5"	19.5"
Weight Armless	53 lb	59 lb
Weight With Arms	67 lb	73 lb
COM	1.85 yd 1.55 yd (BN)	1.85 yd 1.55 yd (BN)
COL	32 sq ft 27 sq ft (BN)	32 sq ft 27 sq ft (BN)
Weight Capacity Warranty	300 lb	300 lb

Ballistic nylon back (BN). Polished aluminum base (B2).

Lumin

LIGHT TASK CHAIR AND TASK STOOL

Light up the room.

Lumin™ is an elegant chair designed for exceptional support and comfort in corporate and education applications. The contoured seat dissipates pressure points for greater comfort while the perforated back adds contemporary style and comfortable breathability. The Lumin light task chair and light task stool are available in black or silver frame finish with matching arm pad colors. Refined, sophisticated Lumin will light up the room.



Featured Models

GOOD :: \$414

All plastic seat and back, basic mechanism, armless, carpet casters

BETTER :: \$565

Plastic back, upholstered seat, basic mechanism, fixed arms, silver frame, carpet casters, grade 1 textile

BEST :: \$588

Upholstered seat and back, basic mechanism, fixed arms, carpet casters, grade 1 textile



Features

- Contemporary design
- Exceptional support and comfort
- Fully upholstered, upholstered seat or plastic
- 14 plastic shell colors
- Two frame finishes with matching arm pads
- Built-in pull handle
- Clean-out space
- 300 lb weight capacity warranty
- Complements Lumin multipurpose chair, counter and bar stool; see page 220





LIGHT TASK CHAIR AND TASK STOOL

1. Back

Back and Seat Style	Code	Price	
Plastic Seat	PS	\$414	
Upholstered Seat Only	US	\$472	
Upholstered Seat and Back	UP	\$530	

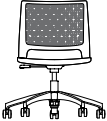

2. Frame

Frame Type	Code	Price	
Task	1012 FT3	+ \$0	
Task Stool	1012 FT3 S21	+ \$132	
Extended Task Stool	1012 FT3 S22	+ \$156	

Frame Finish	Code	Price	
Black	FC1	+ \$0	
Silver	FC2	+ \$35	

Lumin task comes with basic mechanism (swivel only).

3. Arms

Arm Style	Code	Price	
Armless	A0	+ \$0	
Fixed	A147	+ \$58	

4. Base

Base Color and Material	Code	Price	
Black Nylon Base (For Black Frame FC1)	B17	+ \$0	
Fog Nylon Base (For Silver Frame FC2)	B21	+ \$0	

Casters or Glides	Code	Price	
Casters			

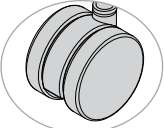
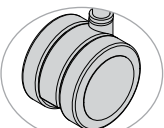
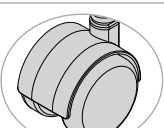
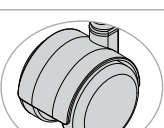
Carpet Casters	C15	+ \$0	
Hard Floor and Carpet Casters	C14	+ \$40	
Self-Locking Carpet Casters	C20	+ \$30	
Self-Locking Hard Floor and Carpet Casters	C19	+ \$64	

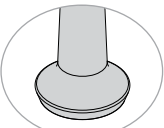
Glides			
Glides for Task Chairs	C3	+ \$30	

Self-locking casters (C19/C20) lock only when not in use.

LIGHT TASK CHAIR AND TASK STOOL

5. Material

Protection	Code	Price	
CAL 133, Fabric, Quantities 1–49	133F	+ \$64	
CAL 133, Fabric, Quantities 50+	133F5	+ \$20	
CAL 133, Plastic, Any Quantity	133P	+ \$10	

Shell Color	Code	Price	
Apple	SC24	+ \$0	
Arctic	SC21	+ \$0	
Bisque	SC7	+ \$0	
Black	SC1	+ \$0	
Chocolate	SC4	+ \$0	
Lagoon	SC15	+ \$0	
Latte	SC20	+ \$0	
Lemon	SC25	+ \$0	
Navy	SC5	+ \$0	
Pacific	SC22	+ \$0	
Red	SC19	+ \$0	
Slate	SC8	+ \$0	
Sterling	SC18	+ \$0	
Tangerine	SC23	+ \$0	

Textile	Code	Price	
Seat Textile Only (For US)			
COM	COM	+ \$0	
Fabric/Vinyl Grade 1	FG1/VG1	+ \$0	
Fabric/Vinyl Grade 2	FG2/VG2	+ \$22	
Fabric/Vinyl Grade 3	FG3/VG3	+ \$45	
Fabric/Vinyl Grade 4	FG4/VG4	+ \$77	
Fabric/Vinyl Grade 5	FG5/VG5	+ \$116	
Fabric/Vinyl Grade 6	FG6/VG6	+ \$159	
Fabric/Vinyl Grade 7	FG7/VG7	+ \$200	

Textile	Code	Price	
Seat and Back Textile (For UP)			
COM	COM	+ \$0	
Fabric Grade 1	FG1/VG1	+ \$0	
Fabric/Vinyl Grade 2	FG2/VG2	+ \$34	
Fabric/Vinyl Grade 3	FG3/VG3	+ \$74	
Fabric/Vinyl Grade 4	FG4/VG4	+ \$121	
Fabric/Vinyl Grade 5	FG5/VG5	+ \$174	
Fabric/Vinyl Grade 6	FG6/VG6	+ \$235	
Fabric/Vinyl Grade 7	FG7/VG7	+ \$296	

Please reference the *Textile Reference Guide* for pricing on fabric over grade 7.

6. Packaging

Packaging	Code	Price
Back Attached to Seat, Base Separate	UC	+ \$0
Fully Assembled in Carton	AC	+ \$120

SPECIFICATIONS

	1012 FT3 Task Chair	1012 FT3 S21 Task Stool	1012 FT3 S22 Extended Task Stool
Overall Width	27"	27"	27"
Overall Depth	27"	27"	27"
Overall Height	31.9"–36.9"	37.9"–45.9"	41.9"–51.9"
Seat Width	18.5"	18.5"	18.5"
Seat Depth	18.2"	18.2"	18.2"
Seat Height	16.62"–21.75"	18"–26"	23"–33"
Back Width	17.5"	17.5"	17.5"
Back Height	18.2"	18.2"	18.2"
Weight Armless	20.5"	25.1"	26"
Weight With Arms	22.2"	26.8"	27.7"
COM	0.85 yd (US) 1 yd (UP)	0.85 yd (US) 1 yd (UP)	0.85 yd (US) 1 yd (UP)
COL	10 sq ft (US) 15 sq ft (UP)	10 sq ft (US) 15 sq ft (UP)	10 sq ft (US) 15 sq ft (UP)
Weight Capacity Warranty	300 lb	300 lb	300 lb

Upholstered seat only (US). Upholstered seat and back (UP).



Best

Mavic

COLLABORATIVE CHAIR

Cross over collaboration.

Mavic™ is here to prove that a jack-of-all-trades can be a master of all. Looks, features, function, comfort and more—there's so much Mavic offers in a single, light-scale seat that it crosses over into new territory. So when it's time to enable collaboration (wherever and whenever you need it), Mavic sits ready to provide a radical new way to work.



Featured Models

GOOD :: \$666

Floating mesh back with integrated arms, swivel-tilt mechanism, black frame and black nylon base, caster ring accent color, carpet casters, grade 1 textile

BETTER :: \$748

Floating mesh back with integrated arms, weight-activated mechanism with recline tilt limiter, white frame and white nylon base, caster ring accent color, carpet casters, grade 1 textile

Features

- Designed by Martin Ballendat
- Slim, single-piece frame design
- Swivel-tilt or weight-activated mechanism
- Eight-hour endurance cushion with 15,000+ textile options
- Built-in lumbar support from tension mesh
- Tapered seat pan with almost-invisible controls
- Advanced adjustments include seat slider and tilt limiter/override
- Performance casters color coordinate with the frame and base
- Three frame and base, 10 mesh and 12 accent color options
- 300 lb weight capacity warranty

1. Back

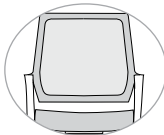
Back Size and Style	Code	Price	
Midback Mesh	1113 MB	\$666	

2. Mechanism

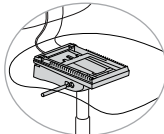
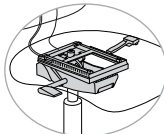
Mechanism	Code	Price	
Swivel-Tilt	T	+ \$0	
Weight-Activated With Override, Tilt Limiter and Seat Slider	WA	+ \$47	

COLLABORATIVE CHAIR

3. Frame

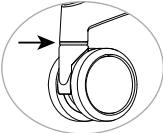
Frame Color	Code	Price	
Black	FC1	+ \$0	
Fog	FC13	+ \$35	
White	FC12	+ \$35	
Frame Color	Code	Price	
Apple	LA12	+ \$0	
Desert	LA3	+ \$0	
Electric Blue	LA5	+ \$0	
Fire	LA6	+ \$0	
Fog	LA4	+ \$0	
Graphite	LA14	+ \$0	
Navy	LA15	+ \$0	
Nickel	LA2	+ \$0	
Ocean	LA10	+ \$0	
Onyx	LA1	+ \$0	
Tangerine	LA9	+ \$0	
White	LA13	+ \$0	

Accent color will apply to caster rings.

4. Base

Base Style	Code	Price	
5-Star Nylon	BT1	+ \$0	

Base Color	Code	Price	
Black Nylon Base	BC1	+ \$0	
Fog Nylon Base	BC4	+ \$0	
White Nylon Base	BC3	+ \$0	

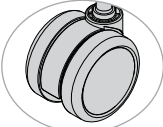
Casters or Glides	Code	Price	
Casters			
Carpet Casters	CS5	+ \$0	
Hard Floor and Carpet Casters	CS6	+ \$40	

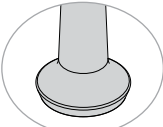
Glides			
Glides for Task Chairs	CS3	+ \$30	

MAVIC

GSA SIN #: 33721

4. Base

Cylinder Height	Code	Price	
Standard Cylinder	CH1	+ \$0	

Frame, base and caster color will correspond when the nylon base (BT1) is selected.

5. Material

Protection	Code	Price	
CAL 133, Fabric, Quantities 1-49	133F	+ \$99	
CAL 133, Fabric, Quantities 50+	133F5	+ \$55	
CAL 133, Leather, Any Quantity	133L	+ \$119	
Mesh Color	Code	Price	
Apple	MC31	+ \$0	
Desert	MC9	+ \$0	
Electric Blue	MC13	+ \$0	
Fire	MC10	+ \$0	
Fog	MC7	+ \$0	
Navy	MC8	+ \$0	
Nickel	MC6	+ \$0	
Ocean	MC29	+ \$0	
Onyx	MC5	+ \$0	
Tangerine	MC28	+ \$0	
Seat Textile	Code	Price	
COM	COM	+ \$0	
Fabric/Vinyl Grade 1	FG1/VG1	+ \$0	
Fabric/Vinyl Grade 2	FG2/VG2	+ \$26	
Fabric/Vinyl Grade 3	FG3/VG3	+ \$60	
Fabric/Vinyl Grade 4	FG4/VG4	+ \$116	
Fabric/Vinyl Grade 5	FG5/VG5	+ \$172	
Fabric/Vinyl Grade 6	FG6/VG6	+ \$213	
Fabric/Vinyl Grade 7	FG7/VG7	+ \$254	
Leather Grade 1	COL	+ \$300	
Leather Grade 1	LG1	+ \$300	
Leather Grade 2	LG2	+ \$380	
Leather Grade 3	LG3	+ \$480	

Please reference the *Textile Reference Guide* for pricing on fabric over grade 7 and leather over grade 3.

COLLABORATIVE CHAIR

6. Packaging

Packaging	Code	Price	
Back Attached to Seat, Base Separate	UC	+ \$0	
Fully Assembled in a Carton	AC	+ \$120	

SPECIFICATIONS

	1113 MB
Overall Width With Arms	23.5"
Overall Depth	23.5"
Overall Height	35.4"
Seat Width	19"
Seat Depth	17.5"
Seat Height	17.5"-21.5"
Back Width	20"
Back Height	20"
Weight With Arms	24.5 lb
COM	0.8 yd
COL	14 sq ft
Weight Capacity Capacity	300 lb



Good

Movi

LIGHT TASK CHAIR AND STOOL

*Movement-inspired.
Collaboration-friendly.*

For all those quick touch bases that end up being anything but, there's the Movi™ light task chair —an agile task chair that can adapt quickly to a constantly changing environment. Whether you need to quickly set up (or clean up), we've got a chair with nesting abilities that can keep up.



Featured Models

GOOD :: \$581

Mesh back, upholstered seat, basic mechanism, armless, black frame, carpet casters, grade 1 textile

BETTER :: \$611

Mesh back, upholstered seat, basic mechanism, fixed arms, black frame, carpet casters, grade 1 textile



BEST :: \$646

Mesh back, upholstered seat, basic mechanism, fixed arms, white frame, carpet casters, grade 1 textile

Features

- Flexes at the hip 14 degrees for enhanced comfort
- Movement-friendly back and arm support
- Clean-out space for easy maintenance
- Bleach-cleanable mesh back
- 12 mesh colors
- Three base frame and caster colors
- Three back frame and arm colors
- Available as an armless option
- Carpet, hard floor and carpet casters available
- 300 lb weight capacity warranty
- Complements Movi nester; see page 233

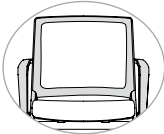

1. Frame

Frame Type	Code	Price	
Task	1062 FT3 MB	\$611	
Task Stool	1062 FT3 S21 MB	\$717	
Extended Task Stool	1062 FT3 S22 MB	\$741	
Back Frame Finish	Code	Price	
Black	SC1	+ \$0	
Fog	SC27	+ \$35	
White	SC26	+ \$35	

Movi task models come with basic mechanism (swivel only).

LIGHT TASK CHAIR AND STOOL

2. Arms

Arm Style	Code	Price	
Armless	AR0	-\$30	
Fixed Arms	AR1	+ \$0	

Arms (AR1) will match frame color.

3. Base

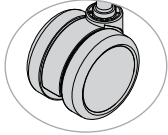
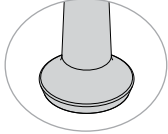
Base Color and Material	Code	Price	
Black Nylon Base With Black Casters	B17	+ \$0	
Fog Nylon Base With Fog Casters	B21	+ \$0	
White Nylon Base With Fog/White Casters	B20	+ \$0	
Casters or Glides	Code	Price	
Casters			
Carpet Casters	CS5	+ \$0	
Hard Floor and Carpet Casters	CS6	+ \$40	
Glides			
Bell Glides	CS20	+ \$30	

4. Material

Protection	Code	Price	
CAL 133, Fabric, Quantities 1-49	133F	+ \$99	
CAL 133, Fabric, Quantities 50+	133F5	+ \$55	
Mesh Color	Code	Price	
Apple	MC31	+ \$0	
Aqua	MC30	+ \$0	
Desert	MC22	+ \$0	
Electric Blue	MC24	+ \$0	
Fire	MC25	+ \$0	
Fog	MC23	+ \$0	
Grape	MC26	+ \$0	
Lemon	MC27	+ \$0	
Nickel	MC21	+ \$0	
Ocean	MC29	+ \$0	
Onyx	MC20	+ \$0	
Tangerine	MC28	+ \$0	
Seat Texture	Code	Price	
COM	COM	+ \$0	
Fabric/Vinyl Grade 1	FG1/VG1	+ \$0	
Fabric/Vinyl Grade 2	FG2/VG2	+ \$22	
Fabric/Vinyl Grade 3	FG3/VG3	+ \$45	
Fabric/Vinyl Grade 4	FG4/VG4	+ \$77	
Fabric/Vinyl Grade 5	FG5/VG5	+ \$116	
Fabric/Vinyl Grade 6	FG6/VG6	+ \$159	
Fabric/Vinyl Grade 7	FG7/VG7	+ \$200	

Please reference the Textile Reference Guide for pricing on fabric over grade 7.

5. Packaging

Packaging	Code	Price	
Back Attached to Seat, Base Separate	UC	+ \$0	
Fully Assembled in Carton	AC	+ \$120	

LIGHT TASK CHAIR AND STOOL

SPECIFICATIONS

	1062 FT3 Light Task Chair	1062 S21 Task Stool	1062 S22 Extended Task Stool
Overall Width	26"	26"	26"
Overall Depth	26"	26"	26"
Overall Height	34.5"	37.75"	41"
Seat Width	19"	19"	19"
Seat Depth	17"	17"	17"
Seat Height	17.5"-22.5"	21.5"-28.5"	24.5"-34"
Back Width	18"	18"	18"
Back Height	18"	18"	18"
Weight Armless	22 lb	27 lb	28 lb
Weight With Arms	23 lb	28 lb	29 lb
COM	0.75 yd	0.75 yd	0.75 yd
COL	10 sq ft	10 sq ft	10 sq ft
Weight Capacity	300 lb	300 lb	300 lb
Warranty			



Non-Stop

HEAVY DUTY TASK CHAIR

Around-the-clock comfort.

Designed for durability and backed by solid steel, Non-Stop™ differs from the typical chair construction in that all mounting points—seat to mech, arms to seat and J-bar to back—are reinforced with heavy-gauge steel mounting brackets. These solid steel fasteners are second to none for reliability and ergonomic comfort in high-intensity environments where chairs perform all day, every day and support a wide range of users. This Heavy Duty chair is rated to accommodate users up to 500 pounds and easily handles the demands of 24-hour environments.



Featured Models

GOOD :: \$1,827

Task size 3, dual torsion mechanism, armless, black aluminum base, carpet casters, grade 1 textile

BETTER :: \$1,987

Task size 3, dual torsion mechanism, large loop arms, black aluminum base, carpet casters, grade 1 textile

BEST :: \$2,154

Task size 3, dual torsion mechanism, large loop arms, polished aluminum base, carpet casters, grade 1 textile

NON-STOP

GSA SIN #: 33721

Features

- Reinforced heavy gauge steel mounting brackets
- Resilient multilayer cushioning
- Waterfall seat promotes proper leg circulation
- Heavy-duty 24/7 option warranted to 500 lb weight capacity



1. Back

Back Size and Style	Code	Price	
Task Size 3: Extra Large	673	\$1,987	

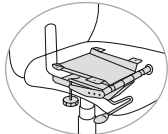
2. Mechanism

Mechanism Style	Code	Price	
Dual Torsion	DT	+ \$0	

3. Arms

Arm Style	Code	Price	
Armless	A0	- \$160	
Large Loop	A72	+ \$0	

4. Base

Base Color and Material	Code	Price	
Black Aluminum Base	B0	+ \$0	
Polished Aluminum Base	B5	+ \$167	

HEAVY DUTY TASK CHAIR

4. Base (Cont.)

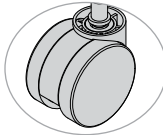
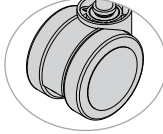
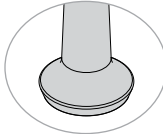
Casters or Glides	Code	Price	
Casters			
Heavy Duty Carpet Casters	C11	+ \$0	
Heavy Duty Hard Floor and Carpet Casters	C9	+ \$61	
Glides			
Glides for Task Chairs	C3	+ \$30	

5. Material

Protection	Code	Price	
CAL 133, Fabric, Quantities 1-49	133F	+ \$99	
CAL 133, Fabric, Quantities 50+	133F5	+ \$55	
Ballistic Nylon			
Ballistic Nylon Back	BN	+ \$0	
Seat and Back Textile			
COM	COM	+ \$0	
Fabric/Vinyl Grade 1	FG1/VG1	+ \$0	
Fabric/Vinyl Grade 2	FG2/VG2	+ \$40	
Fabric/Vinyl Grade 3	FG3/VG3	+ \$84	
Fabric/Vinyl Grade 4	FG4/VG4	+ \$156	
Fabric/Vinyl Grade 5	FG5/VG5	+ \$228	
Fabric/Vinyl Grade 6	FG6/VG6	+ \$304	
Fabric/Vinyl Grade 7	FG7/VG7	+ \$378	

Please reference the Textile Reference Guide for pricing on fabric over grade 7.

6. Packaging

Packaging	Code	Price	
Back Attached to Seat, Base Separate	UC	+ \$0	

HEAVY DUTY TASK CHAIR

SPECIFICATIONS

	673 Task Chair Size 3
Overall Width	30"
Overall Depth	28.5"
Overall Height	39.5"
Seat Width	23"
Seat Depth	19.5"
Seat Height	20.375"-23.25"
Back Width	22"
Back Height	21.5" (DT)
Weight Armless	67 lb (DT)
Weight With Arms	79 lb (DT)
COM	2.5 yd 2 yd (BN)
COL	44 sq ft 35 sq ft (BN)
Weight Capacity Warranty	500 lb

Ballistic nylon back (BN).



Better

Non-Stop

HEAVY DUTY TASK STOOL

Around-the-clock comfort.

Designed for durability and backed by solid steel; Non-Stop™ differs from the typical stool construction in that all mounting points—seat to mech, arms to seat and J-bar to back—are reinforced with heavy-gauge steel mounting brackets. These solid steel fasteners are second to none for reliability and ergonomic comfort in high-intensity environments where chairs perform all day, every day and support a wide range of users. This Heavy Duty stool is rated to accommodate users up to 350 pounds and easily handles the demands of 24-hour environments.



Featured Models

GOOD :: \$1,406

Size 1 task stool, basic mechanism, armless, black nylon base, carpet casters, grade 1 textile

BETTER :: \$1,566

Size 1 task stool, basic mechanism, height-adjustable arms, black nylon base, carpet casters, grade 1 textile

BEST :: \$1,787

Size 1 task stool, basic mechanism, height-/width-adjustable arms, extended stool kit, polished aluminum base, carpet casters, grade 1 textile

NON-STOP

GSA SIN #: 33721

Features



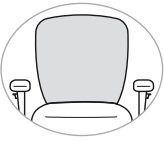

- Reinforced heavy gauge steel mounting brackets
- Resilient multilayer cushioning
- Waterfall seat promotes proper leg circulation
- Heavy-duty 24/7 option warranted to 350 lb weight capacity

1. Back

Back Size and Style	Code	Price	
Task Size 1: Heavy Duty Stool	671 B2	\$1,566	

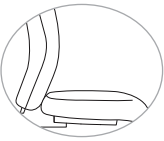
Only available with basic mechanism (swivel only).

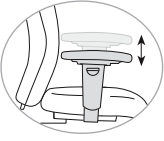
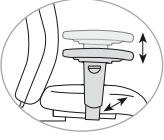
2. Arms

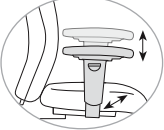
Arm Style	Code	Price	
Armless	A0	- \$160	
Small Loop	A67	+ \$0	
Height-Adjustable	A68	+ \$0	
Height-/Width-Adjustable	A69	+ \$30	
Height-Adjustable Break-Away	A71	+ \$30	
Height-/Width-Adjustable Articulating	A70	+ \$62	

HEAVY DUTY TASK STOOL

3. Base

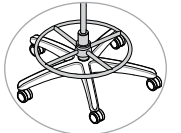
Base	Code	Price	
Standard Stool Kit	S1HD	+ \$0	
Extended Stool Kit	S2HD	+ \$24	

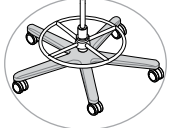
Base Color and Material	Code	Price	
Black Nylon Base	B0	+ \$0	
Black Aluminum	B4	+ \$167	
Polished Aluminum Base	B5	+ \$167	

Casters or Glides	Code	Price	
Casters			

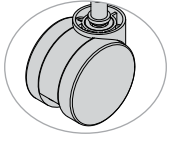
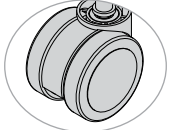
Heavy Duty Carpet Casters	C11	+ \$0	
Heavy Duty Hard Floor and Carpet Casters	C9	+ \$61	

Glides			
Glides for Task Chairs	C3	+ \$30	

4. Material (Cont.)

Protection	Code	Price	
CAL 133, Fabric, Quantities 1-49	133F	+ \$99	
CAL 133, Fabric, Quantities 50+	133F5	+ \$55	
Ballistic Nylon	Code	Price	
Ballistic Nylon Back	BN	+ \$0	
Seat and Back Textile	Code	Price	
COM	COM	+ \$0	
Fabric/Vinyl Grade 1	FG1/VG1	+ \$0	
Fabric/Vinyl Grade 2	FG2/VG2	+ \$40	
Fabric/Vinyl Grade 3	FG3/VG3	+ \$84	
Fabric/Vinyl Grade 4	FG4/VG4	+ \$156	
Fabric/Vinyl Grade 5	FG5/VG5	+ \$228	
Fabric/Vinyl Grade 6	FG6/VG6	+ \$304	
Fabric/Vinyl Grade 7	FG7/VG7	+ \$378	

Please reference the Textile Reference Guide for pricing on fabric over grade 7.

5. Packaging

Packaging	Code	Price	
Knocked Down	KD	+ \$0	
Back Attached to Seat, Base Separate	UC	+ \$80	

HEAVY DUTY TASK STOOL

SPECIFICATIONS

	671B2 S1HD Task Stool	671B2 S2HD Extended Task Stool
Overall Width	27.5"	27.5"
Overall Depth	26.5"	26.5"
Overall Height	40"	42.5"
Seat Width	19.5"	19.5"
Seat Depth	19.5"	19.5"
Seat Height	23"-31"	25.5"-35.5"
Back Width	20.5"	20.5"
Back Height	16"	16"
Weight Armless	55 lb	55 lb
Weight With Arms	68 lb	68 lb
COM	1.75 yd 1.3 yd (BN)	1.75 yd 1.3 yd (BN)
COL	30 sq ft 22 sq ft (BN)	30 sq ft 22 sq ft (BN)
Weight Capacity Warranty	350 lb	350 lb

Ballistic nylon back (BN).

NOVO

MESH BACK TASK CHAIR

*Hyper-customizable.
Super-ergonomic.*

Since its launch in 2016, our Novo™ task chair has been recognized for its designer-friendly features and superior ergonomics. With comfort-first design that's also customizable down to the last detail (we offer 13 choices for lumbar accent colors alone!), personalizing is easy—whether you need something professional for the boardroom or vibrant for a modern, collaborative space.



reddot design award
winner 2017



Gold Award
presented by
contract



INTERIOR
DESIGN



Featured Models

GOOD :: \$529

Midback mesh with adjustable lumbar, black frame, swivel-tilt mechanism, height-adjustable arms, black nylon base, grade 1 textile

BETTER :: \$575

Highback mesh with adjustable lumbar, black frame, standard synchro mechanism, height-adjustable arms, black nylon base, grade 1 textile



BEST :: \$719

Highback mesh with adjustable lumbar, fog frame, standard synchro mechanism with seat-depth adjustment, multi-adjustable arms, fog nylon base, grade 1 textile

Features

- Midback and highback task chairs
- Adjustable lumbar support comes standard on all models
- Three frame colors with matching base
- Three lumbar colors with 13 lumbar accent colors
- 13 mesh colors
- Basic, standard synchro and swivel-tilt mechanisms
- Three arm types: fixed, height-adjustable or multi-adjustable (height/width)
- Textured, easy-grip arms
- Adjustable seat depth (optional)
- Polished aluminum base (optional)
- Waterfall seat
- Standard 300 lb weight capacity warranty;
Heavy Duty Series 400 lb weight capacity warranty

1. Back

Back Size and Style	Code	Price	
Midback Mesh With Adjustable Lumbar Support	1033 BK1	\$547	
Highback Mesh With Adjustable Lumbar Support	1033 BK2	\$575	

Adjustable Lumbar Color	Code	Price	
Black	AL1	+ \$0	
White	AL2	+ \$0	
Fog	AL3	+ \$0	

1. Back (Cont.)

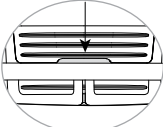

Lumbar Accent Color	Code	Price	
Apple	LA12	+ \$0	
Aqua	LA11	+ \$0	
Desert	LA3	+ \$0	
Electric Blue	LA5	+ \$0	
Fire	LA6	+ \$0	
Fog	LA4	+ \$0	
Grape	LA7	+ \$0	
Lemon	LA8	+ \$0	
Nickel	LA2	+ \$0	
Ocean	LA10	+ \$0	
Onyx	LA1	+ \$0	
Tangerine	LA9	+ \$0	
White	LA13	+ \$0	

2. Heavy Duty

Heavy Duty Series	Code	Price	
Large and Tall (Black Highback Frame With Enhanced Synchro Y Mechanism and Sport Height-Adjustable Arms)	LT	+ \$295	

See page 38 for additional LT and HD options.

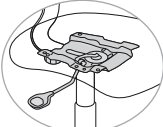
3. Mechanism

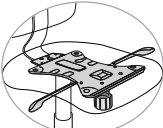
Mechanism Style	Code	Price	
Basic (Swivel Only)	B	- \$33	
Swivel-Tilt	T	- \$18	
Standard Synchro	F	+ \$0	

3. Mechanism (Cont.)

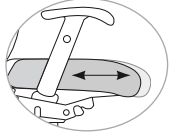

Seat-Depth Adjustment	Code	Price	
Seat-Depth Adjustment	E3	+ \$79	

Seat-depth adjustment (E3) not available with basic (B) or swivel-tilt (T) mechanisms or on lower cylinder (CH4).

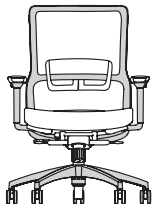
4. Frame

Frame Color	Code	Price	
Black	FC1	+ \$0	
White	FC12	+ \$35	
Fog	FC13	+ \$35	

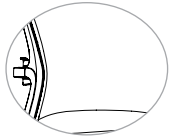
5. Arms

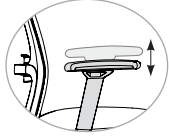
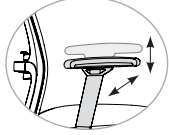
Arm Style	Code	Price	
Armless	AR0	- \$48	
Fixed Task	AR2	- \$10	
Height-Adjustable	AR4	+ \$0	
Multi-Adjustable (Height/Width)	AR6	+ \$30	

MESH BACK TASK CHAIR

6. Base

Base Color and Material	Code	Price	
Black Nylon Base (For Black Frame FC1)	B17	+ \$0	
White Nylon Base (For White Frame FC12)	B20	+ \$0	
Fog Nylon Base (For Fog Frame FC13)	B21	+ \$0	

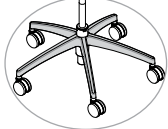
Polished Aluminum Base	B18	+ \$113	
------------------------	-----	---------	---

Casters or Glides	Code	Price	
Casters			

Carpet Casters	CS5	+ \$0	
----------------	-----	-------	---

Hard Floor and Carpet Casters	CS6	+ \$40	
-------------------------------	-----	--------	--

Glides			
---------------	--	--	--

Glides for Task Chairs	CS3	+ \$30	
------------------------	-----	--------	---

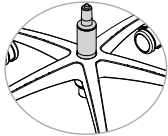
Cylinder Height	Code	Price	
Standard Cylinder	CH1	+ \$0	
Higher Cylinder	CH3	+ \$0	
Lower Cylinder	CH4	+ \$0	

Nylon bases must match frame color. The polished aluminum base (B18) can be ordered with any frame color.

Higher cylinder (CH3) and lower cylinder (CH4) options are only available with the black nylon base (B17). Style of nylon base will change with higher or lower cylinder.

7. Material

Protection	Code	Price
CAL 133, Fabric, Quantities 1-49	133F	+ \$99

CAL 133, Fabric, Quantities 50+	133F5	+ \$55
---------------------------------	-------	--------

CAL 133, Leather, Any Quantity	133L	+ \$119
--------------------------------	------	---------

Mesh Color	Code	Price
------------	------	-------

Apple	MC31	+ \$0
-------	------	-------

Aqua	MC30	+ \$0
------	------	-------

Desert	MC22	+ \$0
--------	------	-------

Electric Blue	MC24	+ \$0
---------------	------	-------

Fire	MC25	+ \$0
------	------	-------

Fog	MC23	+ \$0
-----	------	-------

Grape	MC26	+ \$0
-------	------	-------

Lemon	MC27	+ \$0
-------	------	-------

Nickel	MC21	+ \$0
--------	------	-------

Ocean	MC29	+ \$0
-------	------	-------

Onyx	MC20	+ \$0
------	------	-------

Tangerine	MC28	+ \$0
-----------	------	-------

Seat Textile	Code	Price
--------------	------	-------

COM	COM	+ \$0
-----	-----	-------

Fabric/Vinyl Grade 1	FG1/VG1	+ \$0
----------------------	---------	-------

Fabric/Vinyl Grade 2	FG2/VG2	+ \$26
----------------------	---------	--------

Fabric/Vinyl Grade 3	FG3/VG3	+ \$60
----------------------	---------	--------

Fabric/Vinyl Grade 4	FG4/VG4	+ \$116
----------------------	---------	---------

Fabric/Vinyl Grade 5	FG5/VG5	+ \$172
----------------------	---------	---------

Fabric/Vinyl Grade 6	FG6/VG6	+ \$213
----------------------	---------	---------

Fabric/Vinyl Grade 7	FG7/VG7	+ \$254
----------------------	---------	---------

COL	COL	+ \$300
-----	-----	---------

Leather Grade 1	LG1	+ \$300
-----------------	-----	---------

Leather Grade 2	LG2	+ \$380
-----------------	-----	---------

Leather Grade 3	LG3	+ \$480
-----------------	-----	---------

Please reference the *Textile Reference Guide* for pricing on fabric over grade 7 and leather over grade 3.

MESH BACK TASK CHAIR

8. Packaging

Packaging	Code	Price
Knocked Down	KD	+ \$0

Back Attached to Seat, Base Separate	UC	+ \$80
--------------------------------------	----	--------

Fully Assembled in a Carton	AC	+ \$200
-----------------------------	----	---------



SPECIFICATIONS

	1033.BK1 Midback Task Chair	1033.BK2 Highback Task Chair
Overall Width Armless	26"	26"
Overall Width With Arms	26"	26"
Overall Depth	26"	26"
Overall Height	36"	39"
Seat Width	20"	20"
Seat Depth	16.5"-18.5"	16.5"-18.5"
Seat Height	16"-19.75" (B) 16.25"-20" (T) 16.75"-20.25" (F)	16"-19.75" (B) 16.25"-20" (T) 16.75"-20.25" (F) 17"-20.625" (F/E3)
Seat Height With Higher Cylinder	16.25"-21.25" (B) 16.5"-21.5" (T) 17"-22" (F) 17.25"-22.25" (F/E3)	16.25"-21.25" (B) 16.5"-21.5" (T) 17"-22" (F) 17.25"-22.25" (F/E3)
Seat Height With Lower Cylinder	14.5"-18.25" (B) 14.75"-17.5" (T) 15.25"-18" (F) 15.5"-18.25" (F/E3)	14.5"-18.25" (B) 14.75"-17.5" (T) 15.25"-18" (F) 15.5"-18.25" (F/E3)
Back Width	19"	19"
Back Height	20"	23"
Weight Armless	31 lb	32 lb
Weight With Arms	37 lb	38 lb
COM	1 yd	1 yd
COL	17 sq ft	17 sq ft
Weight Capacity Warranty	300 lb	300 lb

Basic mechanism (B). Swivel-tilt mechanism (T). Standard synchro mechanism (F).
Seat-depth adjustment (E3). Enhanced synchro mechanism (Y).

MESH BACK TASK CHAIR

SPECIFICATIONS

	1033.BK2 LT Large and Tall Task Chair
Overall Width Armless	26"
Overall Width With Arms	29"
Overall Depth	27.75"
Overall Height	39"
Seat Width	22"
Seat Depth	17.5"-19.5"
Seat Height	17.5"-21.5" (Y)
Seat Height With Higher Cylinder	18"-23" (Y)
Back Width	19"
Back Height	21.5"
Weight Armless	46 lb
Weight With Arms	52 lb
COM	1.15 yd
COL	18 sq ft
Weight Capacity Warranty	400 lb

Enhanced synchro mechanism (Y).

Novo

MESH BACK TASK STOOL

*Hyper-customizable.
Super-ergonomic.*

Since its launch in 2016, our Novo™ collection has been recognized for its designer-friendly features and superior ergonomics. With comfort-first design that's also customizable down to the last detail (we offer 13 choices for lumbar accent colors alone!), personalizing is easy—whether you need something professional for the boardroom or vibrant for a modern, collaborative space.



reddot design award
winner 2017



Featured Models

GOOD :: \$576

Midback mesh with adjustable lumbar, basic mechanism, armless, black frame, black nylon base, carpet casters, grade 1 textile

BETTER :: \$624

Midback mesh with adjustable lumbar, basic mechanism, black frame, height-adjustable arms, black nylon base, carpet casters, grade 1 textile



BEST :: \$689

Midback mesh with adjustable lumbar, basic mechanism, white frame, multi-adjustable arms, white nylon base, carpet casters, grade 1 textile

Features

- Midback task stool
- Adjustable lumbar support comes standard on all models
- Three frame colors with matching base
- Three lumbar colors with 13 lumbar accent colors
- 13 mesh colors
- Basic, standard synchro and swivel-tilt mechanisms
- Three arm types: fixed, height-adjustable or multi-adjustable (height/width)
- Textured, easy-grip arms
- Adjustable seat depth (optional)
- Polished aluminum base (optional)
- Waterfall seat
- Standard 300 lb weight capacity

1. Back

Back Size and Style	Code	Price	
Midback Mesh Task Stool With Adjustable Lumbar Support	1033 BK1	\$624	
Adjustable Lumbar Color	Code	Price	
Black	AL1	+ \$0	
White	AL2	+ \$0	
Fog	AL3	+ \$0	

1. Back (Cont.)

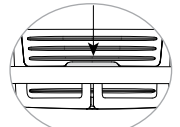
Lumbar Accent Color	Code	Price	
Apple	LA12	+ \$0	
Aqua	LA11	+ \$0	
Desert	LA3	+ \$0	
Electric Blue	LA5	+ \$0	
Fire	LA6	+ \$0	
Fog	LA4	+ \$0	
Grape	LA7	+ \$0	
Lemon	LA8	+ \$0	
Nickel	LA2	+ \$0	
Ocean	LA10	+ \$0	
Onyx	LA1	+ \$0	
Tangerine	LA9	+ \$0	
White	LA13	+ \$0	

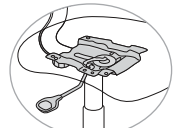

2. Mechanism

Mechanism Style	Code	Price	
Basic (Swivel Only)	B	+ \$0	

3. Frame

Frame Color	Code	Price	
Black	FC1	+ \$0	
White	FC12	+ \$35	
Fog	FC13	+ \$35	

4. Arms

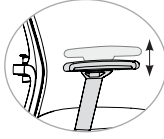
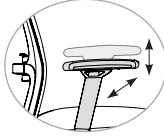
Arm Style	Code	Price	
Armless	AR0	- \$48	
Fixed Task	AR2	- \$10	
Height-Adjustable	AR4	+ \$0	
Multi-Adjustable (Height/Width)	AR6	+ \$30	

5. Base

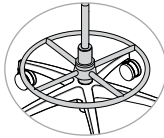
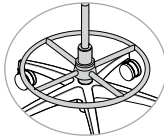
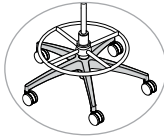
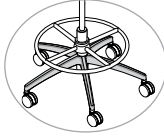
Base	Code	Price	
Stool Kit	S1	+ \$0	
Extended Stool Kit	S2	+ \$24	
Base Color and Material	Code	Price	
Black Nylon Base (For Black Frame FC1)	B17	+ \$0	
White Nylon Base (For White Frame FC12)	B20	+ \$0	
Fog Nylon Base (For Fog Frame FC13)	B21	+ \$0	
Polished Aluminum Base	B18	+ \$113	

MESH BACK TASK STOOL

5. Base (Cont.)

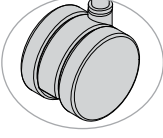
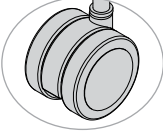
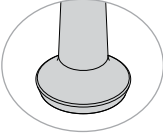
Casters or Glides	Code	Price	
Casters			
Carpet Casters	CS5	+ \$0	
Hard Floor and Carpet Casters	CS6	+ \$40	
Glides			
Glides for Task Chairs	CS3	+ \$30	

Nylon bases must match frame color. The polished aluminum base (B18) can be ordered with any frame color.

6. Material

Protection	Code	Price	
CAL 133, Fabric, Quantities 1-49	133F	+ \$99	
CAL 133, Fabric, Quantities 50+	133F5	+ \$55	
CAL 133, Leather, Any Quantity	133L	+ \$119	
Mesh Color	Code	Price	
Apple	MC31	+ \$0	
Aqua	MC30	+ \$0	
Desert	MC22	+ \$0	
Electric Blue	MC24	+ \$0	
Fire	MC25	+ \$0	
Fog	MC23	+ \$0	
Grape	MC26	+ \$0	
Lemon	MC27	+ \$0	
Nickel	MC21	+ \$0	
Ocean	MC29	+ \$0	
Onyx	MC20	+ \$0	
Tangerine	MC28	+ \$0	

6. Material (Cont.)

Seat Textile	Code	Price
COM	COM	+ \$0
Fabric/Vinyl Grade 1	FG1/VG1	+ \$0
Fabric/Vinyl Grade 2	FG2/VG2	+ \$26
Fabric/Vinyl Grade 3	FG3/VG3	+ \$60
Fabric/Vinyl Grade 4	FG4/VG4	+ \$116
Fabric/Vinyl Grade 5	FG5/VG5	+ \$172
Fabric/Vinyl Grade 6	FG6/VG6	+ \$213
Fabric/Vinyl Grade 7	FG7/VG7	+ \$254
COL	COL	+ \$300
Leather Grade 1	LG1	+ \$300
Leather Grade 2	LG2	+ \$380
Leather Grade 3	LG3	+ \$480

Please reference the *Textile Reference Guide* for pricing on fabric over grade 7 and leather over grade 3.



MESH BACK TASK STOOL

7. Packaging

Packaging	Code	Price
Knocked Down	KD	+ \$0
Back Attached to Seat, Base Separate	UC	+ \$80
Fully Assembled in a Carton	AC	+ \$200

SPECIFICATIONS

	1033.BK1 S1 Midback Task Stool	1033.BK1 S2 Extended Task Stool
Overall Width	26"	27"
Overall Depth	26"	27"
Overall Height	39"	42"
Seat Width	20"	20"
Seat Depth	16.5"	16.5"
Seat Height	21.375"-29"	24.25"-34.25"
Back Width	19"	19"
Back Height	20"	20"
Weight Armless	29 lb	30 lb
Weight With Arms	35 lb	36 lb
COM	1 yd	1 yd
COL	17 sq ft	17 sq ft
Weight Capacity Warranty	300 lb	300 lb

OnCall

LIGHT TASK CHAIR AND TASK STOOL

*High performance,
low maintenance.*

Perfect for collaboration spaces, the lightweight OnCall™ task chair and stool feature the collection's signature built-in crescent handle and back cut-out. Mix and match with fabrics from our vast collection for the seat, back or both to create an affordable addition to creative workstations or any impromptu meeting.



Featured Models

GOOD :: \$378

All plastic, swivel-tilt mechanism, armless, carpet casters, grade 1 textile

BETTER :: \$436

Upholstered seat and plastic back, swivel-tilt mechanism, armless, carpet casters, grade 1 textile

BEST :: \$552

Upholstered seat and back, swivel-tilt mechanism, fixed arms, carpet casters, grade 1 textile



Features

- Task chair and task stool
- Fully upholstered, upholstered seat or plastic
- Nine plastic colors
- Built-in pull handle
- 250 lb weight capacity warranty
- Complements OnCall multipurpose chair and bar stool; see page 236

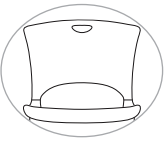
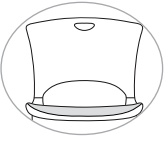
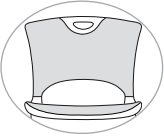
1. Back

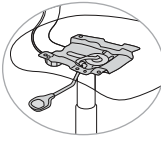

Back and Seat Style	Code	Price	
Plastic	No Code	\$378	
Upholstered Seat Only	US	\$436	
Upholstered Seat and Back	UP	\$494	

2. Mechanism

Mechanism Style	Code	Price	
Basic (Swivel Only)	B	- \$50	
Swivel-Tilt	T	+ \$0	

Swivel-tilt (T) mechanism not available on task stool models (S1/S2).

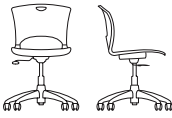
3. Frame

Frame Type	Code	Price	
Task	90T	+ \$0	
Task Stool	90TB S1	+ \$132	
Extended Task Stool	90TB S2	+ \$156	



Better

4. Arms

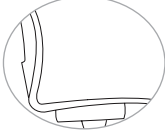
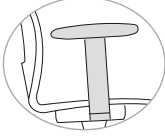
Arm Style	Code	Price	
Armless	A0	+ \$0	
Fixed Task	A42	+ \$58	

5. Base

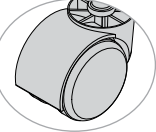
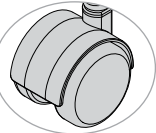
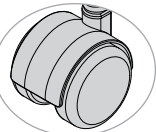
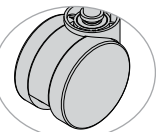
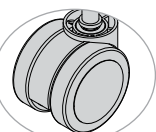
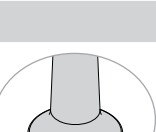
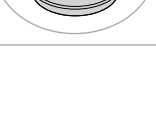
Casters or Glides	Code	Price	
Casters			
Carpet Casters	C6	+ \$0	
Hard Floor and Carpet Casters	C1	+ \$40	
Self-Locking Carpet Casters	C2	+ \$30	
Self-Locking Hard Floor and Carpet Casters	C7	+ \$61	
Heavy Duty Carpet Casters	C11	+ \$30	
Heavy Duty Hard Floor and Carpet Casters	C9	+ \$61	
Glides			
Glides for Task Chairs	C3	+ \$30	

Self-locking casters (C2/C7) lock only when not in use.

LIGHT TASK CHAIR AND TASK STOOL

6. Material

Protection	Code	Price	
CAL 133, Fabric, Quantities 1-49	133F	+ \$99	
CAL 133, Fabric, Quantities 50+	133F5	+ \$55	
CAL 133, Plastic, Any Quantity	133P	+ \$45	
Shell Color	Code	Price	
Arctic	SC21	+ \$0	
Black	SC1	+ \$0	
Chocolate	SC4	+ \$0	
Lagoon	SC15	+ \$0	
Latte	SC20	+ \$0	
Navy	SC5	+ \$0	
Red	SC19	+ \$0	
Slate	SC8	+ \$0	
Sterling	SC18	+ \$0	
Textile	Code	Price	
Seat Textile Only (For US)			
COM	COM	+ \$0	
Fabric/Vinyl Grade 1	FG1/VG1	+ \$0	
Fabric/Vinyl Grade 2	FG2/VG2	+ \$22	
Fabric/Vinyl Grade 3	FG3/VG3	+ \$45	
Fabric/Vinyl Grade 4	FG4/VG4	+ \$77	
Fabric/Vinyl Grade 5	FG5/VG5	+ \$116	
Fabric/Vinyl Grade 6	FG6/VG6	+ \$159	
Fabric/Vinyl Grade 7	FG7/VG7	+ \$200	
Seat and Back Textile (For UP)			
COM	COM	+ \$0	
Fabric/Vinyl Grade 1	FG1/VG1	+ \$0	
Fabric/Vinyl Grade 2	FG2/VG2	+ \$34	
Fabric/Vinyl Grade 3	FG3/VG3	+ \$74	
Fabric/Vinyl Grade 4	FG4/VG4	+ \$121	
Fabric/Vinyl Grade 5	FG5/VG5	+ \$174	
Fabric/Vinyl Grade 6	FG6/VG6	+ \$235	
Fabric/Vinyl Grade 7	FG7/VG7	+ \$296	

Please reference the Textile Reference Guide for pricing on fabric over grade 7.

7. Packaging

Packaging	Code	Price	
Back Attached to Seat, Base Separate	UC	+ \$0	
Fully Assembled in a Carton	AC	+ \$120	

LIGHT TASK CHAIR AND TASK STOOL

SPECIFICATIONS

	90T Task Chair	90T S1 Task Stool	90T S2 Extended Task Stool
Overall Width	26"	26"	26"
Overall Depth	26.5"	26"	26"
Overall Height	34"	37.5"	41.5"
Seat Width	18"	18"	18"
Seat Depth	17.5"	17.5"	17.5"
Seat Height	16.5"-20.5"	20"-28"	24"-34"
Back Width	19"	19"	19"
Back Height	15"	15"	15"
Weight Armless	26.2 lb	25.5 lb	25.5 lb
Weight With Arms	32.2 lb	29 lb	29 lb
COM	0.8 (US) 0.85 (UP)	0.8 (US) 0.85 (UP)	0.8 (US) 0.85 (UP)
Weight Capacity Warranty	250 lb	250 lb	250 lb



Best

Prava

CONFERENCE CHAIR

Command performance.

The Jorge Pensi designed Prava™ chair has double-stitched detailing and revolutionary molded-foam construction. The midback model is ideal for conference room use while the highback is well suited for any executive. A plush foam cushion in the center of the backrest offers ultimate comfort. A wide array of comfort and control options are available including three arm styles, choice of swivel-tilt, knee tilt or enhanced synchro adjustments. Modern and sophisticated with restrained elegance, Prava embodies the precise balance between refinement and comfort.



Featured Models

GOOD :: \$722

Midback, swivel-tilt mechanism
black fixed loop arms, black nylon
base, carpet casters, grade 1 textile

BETTER :: \$755

Midback, knee-tilt mechanism, fixed
loop black nylon arms, black nylon
base, carpet casters, grade 1 textile

BEST :: \$1,017

Highback, enhanced synchro
mechanism, fully adjustable black
nylon arms, polished aluminum base,
carpet casters, grade 1 textile

Features

- Sleek European styling
- Soft, plush foam back
- Perimeter foam for a tailored profile
- Jorge Pensi design
- Double-stitch detailing
- Aluminum accents
- Waterfall seat
- 300 lb weight capacity warranty

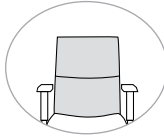

1. Back

Back Size and Style	Code	Price	
Midback	6422	\$755	
Highback	6423	\$787	
Back Options	Code	Price	
Headrest, Matches Chair Textile	HR1C0	+ \$95	

Headrest is available on highback models only.

CONFERENCE CHAIR



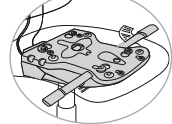

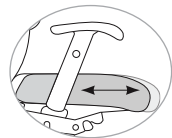
2. Mechanism

Mechanism Style	Code	Price	
Swivel-Tilt	T	- \$33	
Knee-Tilt	K	+ \$0	
Enhanced Synchro	Y	+ \$57	

Seat-Depth Adjustment	Code	Price	
Seat-Depth Adjustment	E3	+ \$79	

Seat-depth adjustment (E3) available on enhanced synchro (Y) mechanism only.

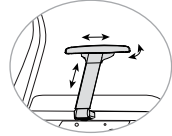
3. Arms

Arm Style	Code	Price	
Armless	A0	- \$75	
Black Fixed Loop	A111	+ \$0	
Silver Fixed Metallic Loop	A112	+ \$74	
Fully Adjustable Black (6-Way)	AR8	+ \$60	

4. Base

Base Color and Material	Code	Price	
Black Nylon Base	B0	+ \$0	
Silver Metallic Base	B11	+ \$113	
Polished Aluminum Base	B3	+ \$113	
Brushed Aluminum Base	B8	+ \$113	

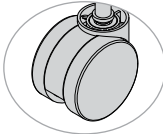
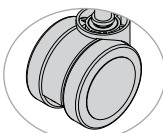
Casters	Code	Price	
Carpet Casters	C21	+ \$0	
Hard Floor and Carpet Casters	C22	+ \$40	

For Aluminum Bases (B3/B8) Only

Carpet Casters	C16	+ \$0	
Hard Floor and Carpet Casters	C17	+ \$40	
Self-Locking Carpet Casters	C20	+ \$30	
Self-Locking Hard Floor and Carpet Casters	C19	+ \$64	

Self-locking casters (C19/C20) lock only when not in use.

5. Material

Protection	Code	Price	
CAL 133, Fabric, Quantities 1-49	133F	+ \$99	
CAL 133, Fabric, Quantities 50+	133F5	+ \$55	
CAL 133, Leather, Any Quantity	133L	+ \$119	
Seat and Back Textile	Code	Price	
COM	COM	+ \$0	
Fabric/Vinyl Grade 1	FG1/VG1	+ \$0	
Fabric/Vinyl Grade 2	FG2/VG2	+ \$36	
Fabric/Vinyl Grade 3	FG3/VG3	+ \$78	
Fabric/Vinyl Grade 4	FG4/VG4	+ \$135	
Fabric/Vinyl Grade 5	FG5/VG5	+ \$196	
Fabric/Vinyl Grade 6	FG6/VG6	+ \$263	
Fabric/Vinyl Grade 7	FG7/VG7	+ \$332	
COL	COL	+ \$252	
Leather Grade 1	LG1	+ \$252	
Leather Grade 2	LG2	+ \$340	
Leather Grade 3	LG3	+ \$460	
Leather Grade 4	LG3	+ \$600	

Please reference the *Textile Reference Guide* for pricing on fabric over grade 7 and leather over grade 3.

6. Packaging

Packaging	Code	Price	
Knocked Down	KD	+ \$0	
Back Attached to Seat, Base Separate	UC	+ \$80	
Fully Assembled in a Carton	AC	+ \$200	

SPECIFICATIONS

	6422 Midback	6423 Highback
Overall Width Armless	19"	19"
Overall Width With Arms	26.75"	26.75"
Overall Depth	26.3"	26.3"
Overall Height	43.125"	46.125"
Seat Width	19"	19"
Seat Depth	19"	19"
Seat Height	17.625"-20.625" (T/K) 19"-22" (Y)	17.5"-20.5" (T/K) 19"-22" (Y)
Back Width	18.25"	18.25"
Back Height	23.75"	26.75"
Weight Armless	42 lb	44 lb
Weight With Arms	50 lb	52 lb
COM	2 yd	2.25 yd
COL	35 sq ft	40 sq ft
Weight Capacity Warranty	300 lb	300 lb

Swivel-tilt mechanism (T). Knee-tilt mechanism (K). Enhanced synchro mechanism (Y).



Good

ReAlign

TASK CHAIR

When sleek contour and control align.

Contemporary tailored lines, a thin profile and enduring comfort make ReAlign™ a perfect chair for both task and conference use. The sculpted, ergonomically designed back and backsheight adjustment provide lumbar support in both midback and highback styles. Seatsdepth adjustment, ballistic nylon back and a Heavy Duty 24/7 option expand the versatility of this collection. With five control mechanisms and five arm styles to choose from, ReAlign can solve almost any office requirement.



Best

Featured Models

GOOD :: \$636

Midback, swivel-tilt mechanism, height-adjustable arms, black nylon base, grade 1 textile

BETTER :: \$726

Midback, enhanced synchro mechanism, height-adjustable arms, black nylon base, grade 1 textile

BEST :: \$856

Highback, enhanced synchro mechanism, fixed loop arms, high profile polished aluminum base, grade 1 vinyl

Features

- Thin profile design
- Ergonomic concave/convex back
- Internal back height adjustment (on Y & M mechanism only)
- Back height adjustment
- CAL 133 approved models
- 300 lb weight capacity warranty;
350 lb Heavy Duty 24/7 weight capacity warranty

1. Back

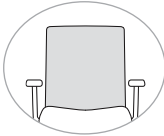
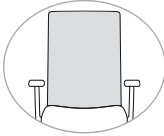
Back Size and Style	Code	Price	
Midback	681	\$726	
Highback	682	\$758	

2. Heavy Duty

Heavy Duty Series	Code	Price	
Heavy Duty	HD	+ \$126	

Heavy Duty option only compatible with multi-function (M), enhanced synchro (Y) and euro glide (A2) mechanisms. See page 38 for additional LT and HD options.

TASK CHAIR

3. Mechanism

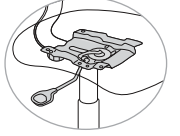
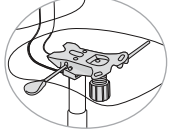
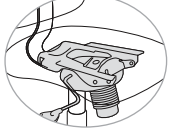
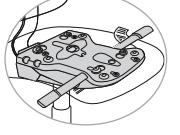
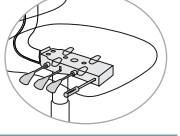
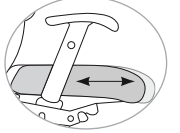
Mechanism Style	Code	Price	
Basic (Swivel Only)	B	- \$127	
Swivel-Tilt	T	- \$90	
Knee-Tilt	K	- \$57	
Enhanced Synchro	Y	+ \$0	
Multi-Function	M	+ \$36	
Seat-Depth Adjustment	Code	Price	
Seat-Depth Adjustment	E3	+ \$79	

Seat-depth only available on multi-function (M) or enhanced synchro (Y) mechanism.

4. Arms

Arm Style	Code	Price	
Armless	A0	- \$90	
Fixed Loop	A77	- \$15	
Height-Adjustable	A73	+ \$0	
Height-Adjustable With Pivot	A75	+ \$10	
Height-/Width-Adjustable	A74	+ \$25	
Height-/Width-Adjustable With Pivot	A76	+ \$45	

TASK CHAIR

5. Base

Base Color and Material	Code	Price	
Black Nylon Base	B0	+ \$0	
Heavy Duty Black Nylon Base, 26" (For HD)	B7	+ \$0	
High Profile Polished Aluminum Base	B3	+ \$113	
Low Profile Base With Higher Cylinder	S8	+ \$0	

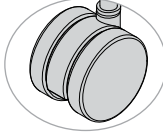
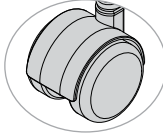
Casters or Glides	Code	Price	
Casters			
Carpet Casters	C15	+ \$0	
Hard Floor and Carpet Casters	C14	+ \$40	
Self-Locking Carpet Casters	C20	+ \$30	
Self-Locking Hard Floor and Carpet Casters	C19	+ \$64	

High profile polished aluminum base (B3) is not available with seat-depth adjustment (E3).

5. Base (Cont.)

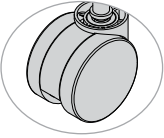
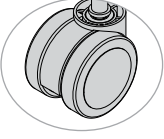
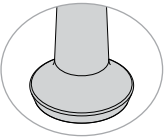
Casters or Glides	Code	Price	
Heavy Duty Casters			
Heavy Duty Carpet Casters	C11	+ \$0	
Heavy Duty Hard Floor and Carpet Casters	C9	+ \$61	
Glides			
Glides for Task Chairs	C3	+ \$30	

Higher cylinder (S8) must use enhanced synchro mechanism (Y) and is only available with low profile base and corresponding casters.

Self-locking casters (C20/C19) lock only when not in use. Heavy Duty casters must use enhanced synchro (Y) mechanism.

6. Material

Protection	Code	Price	
CAL 133, Fabric, Quantities 1-49	133F	+ \$99	
CAL 133, Fabric, Quantities 50+	133F5	+ \$55	
CAL 133, Leather, Any Quantity	133L	+ \$119	
Ballistic Nylon	Code	Price	
Ballistic Nylon Back	BN	+ \$0	
Seat and Back Textile	Code	Price	
COM	COM	+ \$0	
Fabric/Vinyl Grade 1	FG1/VG1	+ \$0	
Fabric/Vinyl Grade 2	FG2/VG2	+ \$36	
Fabric/Vinyl Grade 3	FG3/VG3	+ \$78	
Fabric/Vinyl Grade 4	FG4/VG4	+ \$135	
Fabric/Vinyl Grade 5	FG5/VG5	+ \$196	
Fabric/Vinyl Grade 6	FG6/VG6	+ \$263	
Fabric/Vinyl Grade 7	FG7/VG7	+ \$332	
COL	COL	+ \$340	
Leather Grade 1	LG1	+ \$340	
Leather Grade 2	LG2	+ \$460	
Leather Grade 3	LG3	+ \$600	

Please reference the Textile Reference Guide for pricing on fabric over grade 7 and leather over grade 3.

TASK CHAIR

7. Packaging

Packaging	Code	Price	
Knocked Down	KD	+ \$0	
Back Attached to Seat, Base Separate	UC	+ \$80	
Fully Assembled in Carton	AC	+ \$200	

SPECIFICATIONS

	681 Midback Task Chair	682 Highback Task Chair
Overall Width	27"	27"
Overall Depth	27"	27"
Overall Height	37.5"	40.5"
Seat Width	19"	19"
Seat Depth	19"	19"
Seat Height (Mechanism)	17"-20" (B) 16.625"-19.75" (T) 16.75"-20.25" (K) 16.5"-20" (I) 16.75"-20.25" (Y/M/A2)	17"-20" (B) 16.625"-19.75" (T) 16.75"-20.25" (K) 16.5"-20" (I) 16.75"-20.25" (Y/M/A2)
Back Width	19"	19"
Back Height	23"	26"
Weight Armless (Mechanism)	38 lb (B) 41 lb (T) 49 lb (K) 49 lb (Y/M)	39 lb (B) 42 lb (T) 50 lb (K) 50 lb (Y/M)
Weight With Arms	45 lb (B) 48 lb (T) 56 lb (K) 56 lb (Y/M)	46 lb (B) 49 lb (T) 57 lb (K) 57 lb (Y/M)
COM	2 yd 1.7 yd (BN)	2.2 yd 1.75 yd (BN)
COL	34 sq ft 30 sq ft (BN)	40 sq ft 32 sq ft (BN)
Weight Capacity Warranty	300 lb 350 lb (HD)	300 lb 350 lb (HD)

Basic mechanism (B). Swivel-tilt mechanism (T). Knee-tilt mechanism (K). Enhanced synchro mechanism (Y). Multi-function mechanism (M). Ballistic nylon back (BN). Heavy Duty (HD).

ReAlign

TASK STOOL

*When sleek contour
and control align.*

Contemporary tailored lines, a thin profile and enduring comfort make ReAlign™ a perfect stool for task use. The sculpted, ergonomically designed back and back height-adjustment provide lumbar support in both midback and highback styles. Seat-depth adjustment and ballistic nylon back expand the versatility of this collection. With five arm styles to choose from, ReAlign can solve almost any of office requirement.



Featured Models

GOOD :: \$685

Midback stool, basic mechanism, armless, black nylon base, grade 1 textile

BETTER :: \$775

Midback stool, basic mechanism, height-adjustable arms, black nylon base, grade 1 textile

BEST :: \$957

Midback stool, basic mechanism, height-/width-adjustable arms with pivot, extended stool kit, high profile polished aluminum base, grade 1 textile

Features

- Thin profile design
- Ergonomic concave/convex back
- 300 lb weight capacity warranty;
350 lb Heavy Duty 24/7 weight capacity warranty

1. Back

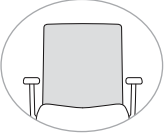
Back Size and Style	Code	Price	
Midback	681B	\$775	

ReAlign task stool (681B) comes with basic mechanism (swivel only).

2. Mechanism

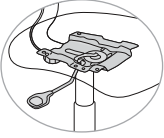



Mechanism Style	Code	Price	
Basic (Swivel Only)	B	+ \$0	

TASK STOOL

3. Arms

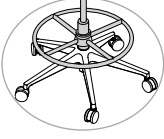
Arm Style	Code	Price	
Armless	A0	- \$90	
Fixed Loop	A77	- \$15	
Height-Adjustable	A73	+ \$0	
Height-Adjustable With Pivot	A75	+ \$10	
Height-/Width-Adjustable	A74	+ \$25	
Height-/Width-Adjustable With Pivot	A76	+ \$45	

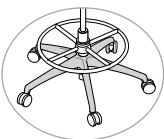
4. Base

Stool Kit	Code	Price	
Standard Stool Kit	S1	+ \$0	
Extended Stool Kit	S2	+ \$24	
Base Color and Material	Code	Price	
Standard Black Nylon Base	N	+ \$0	
High Profile Polished Aluminum Base	B3	+ \$113	

4. Base (Cont.)

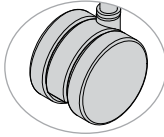
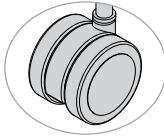
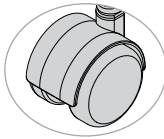
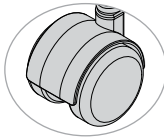
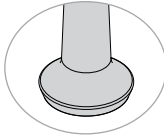
Casters or Glides	Code	Price	
Casters			
Carpet Casters	C15	+ \$0	
Hard Floor and Carpet Casters	C14	+ \$40	
Self-Locking Carpet Casters	C20	+ \$30	
Self-Locking Hard Floor and Carpet Casters	C19	+ \$64	
Glides			
Glides for Task Chairs	C3	+ \$30	

Self-locking casters (C19/C20) lock only when not in use.

5. Material

Protection	Code	Price	
CAL 133, Fabric, Quantities 1-49	133F	+ \$99	
CAL 133, Fabric, Quantities 50+	133F5	+ \$55	
CAL 133, Leather, Any Quantity	133L	+ \$119	
Ballistic Nylon			
Ballistic Nylon Back	BN	+ \$0	

TASK STOOL

5. Material (Cont.)

Seat and Back Textile	Code	Price	
COM	COM	+ \$0	
Fabric/Vinyl Grade 1	FG1/VG1	+ \$0	
Fabric/Vinyl Grade 2	FG2/VG2	+ \$36	
Fabric/Vinyl Grade 3	FG3/VG3	+ \$78	
Fabric/Vinyl Grade 4	FG4/VG4	+ \$135	
Fabric/Vinyl Grade 5	FG5/VG5	+ \$196	
Fabric/Vinyl Grade 6	FG6/VG6	+ \$263	
Fabric/Vinyl Grade 7	FG7/VG7	+ \$332	
COL	COL	+ \$340	
Leather Grade 1	LG1	+ \$340	
Leather Grade 2	LG2	+ \$460	
Leather Grade 3	LG3	+ \$600	

Please reference the Textile Reference Guide for pricing on fabric over grade 7 and leather over grade 3.

6. Packaging

Packaging	Code	Price	
Knocked Down	KD	+ \$0	
Back Attached to Seat, Base Separate	UC	+ \$80	
Fully Assembled in Carton	AC	+ \$200	

SPECIFICATIONS

	681B S1 Midback Task Stool	681B S2 Midback Extended Task Stool
Overall Width	27"	27"
Overall Depth	27"	27"
Overall Height	41.25"-49.25"	45.25"-56.38"
Seat Width	19"	19"
Seat Depth	19"	19"
Seat Height	21.5"-29.5"	25.5"-33.5"
Back Width	19"	19"
Back Height	23"	23"
Weight Armless	38 lb	39 lb
Weight With Arms	45 lb	46 lb
COM	2 yd 1.7 yd (BN)	2 yd 1.7 yd (BN)
COL	34 sq ft 30 sq ft (BN)	40 sq ft 32 sq ft (BN)
Weight Capacity Warranty	300 lb	300 lb

Ballistic nylon back (BN).

Relay

LIGHT TASK CHAIR AND TASK STOOL

Durable and adaptable to the finish.

Great to look at, Relay™ provides lasting comfort in a stylish design that makes an appealing multipurpose seating option for meeting, training, conference and break rooms. The seat and back are molded from high-impact thermoplastic for lasting durability and comfort. Add the optional upholstered seat and back for a more sophisticated, inviting look and added comfort.



Featured Models

GOOD :: \$418

Light task chair, plastic seat and back, basic mechanism, armless, carpet casters

BETTER :: \$526

Light task chair, upholstered seat and plastic back, swivel-tilt mechanism, armless, carpet casters, grade 1 textile

BEST :: \$642

Light task chair, upholstered seat and back, swivel-tilt mechanism, fixed arms cantilever, carpet casters, grade 1 textile

RELAY

GSA SIN #: 33721



Features

- Structurally reinforced and durable back
- High-impact polypropylene
- Fully upholstered, upholstered seat or plastic
- Nine plastic colors
- 250 lb weight capacity warranty
- Complements Relay multipurpose and nester chairs; see page 246

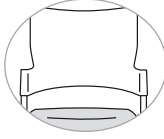
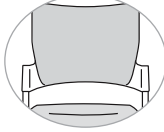
1. Back

Back and Seat Style	Code	Price	
Plastic	No Code	\$418	
Upholstered Seat Only	US	\$476	
Upholstered Seat and Back	UP	\$534	

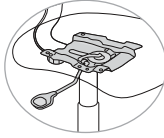

2. Mechanism

Mechanism Style	Code	Price	
Basic (Swivel Only)	B	+\$0	
Swivel-Tilt	T	+\$50	

Swivel-tilt (T) mechanism not available with task stool (S1) or extended task stool (S2).



LIGHT TASK CHAIR AND TASK STOOL

3. Frame



Frame Type	Code	Price	
Task Chair	94T	+\$0	
Task Stool	94B S1	+\$132	
Extended Task Stool	94B S2	+\$156	



4. Arms

Arm Style	Code	Price	
Armless	A0	+ \$0	
Fixed Cantilever	A60	+ \$58	

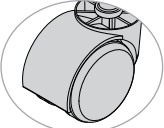
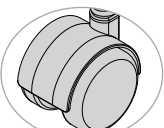
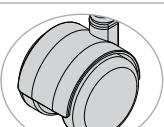
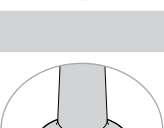
5. Base

Casters or Glides	Code	Price	
Casters			
Carpet Casters	C6	+ \$0	
Hard Floor and Carpet Casters	C1	+ \$40	
Self-Locking Carpet Casters	C2	+ \$30	
Self-Locking Hard Floor and Carpet Casters	C7	+ \$61	
Glides			
Glides for Task Chairs	C3	+ \$30	

Self-locking casters lock only when not in use.

LIGHT TASK CHAIR AND TASK STOOL

6. Material

Protection	Code	Price	
CAL 133, Fabric, Quantities 1-49	133F	+ \$99	
CAL 133, Fabric, Quantities 50+	133F5	+ \$55	
CAL 133, Plastic, Any Quantity	133P	+ \$45	
Shell Color	Code	Price	
Arctic	SC21	+ \$0	
Black	SC1	+ \$0	
Chocolate	SC4	+ \$0	
Lagoon	SC15	+ \$0	
Latte	SC20	+ \$0	
Navy	SC5	+ \$0	
Red	SC19	+ \$0	
Slate	SC8	+ \$0	
Sterling	SC18	+ \$0	
Textile	Code	Price	
Seat Textile (US)			
COM	COM	+ \$0	
Fabric/Vinyl Grade 1	FG1/VG1	+ \$0	
Fabric/Vinyl Grade 2	FG2/VG2	+ \$22	
Fabric/Vinyl Grade 3	FG3/VG3	+ \$45	
Fabric/Vinyl Grade 4	FG4/VG4	+ \$77	
Fabric/Vinyl Grade 5	FG5/VG5	+ \$116	
Fabric/Vinyl Grade 6	FG6/VG6	+ \$159	
Fabric/Vinyl Grade 7	FG7/VG7	+ \$200	
Seat and Back Textile (UP)			
COM	COM	+ \$0	
Fabric/Vinyl Grade 1	FG1/VG1	+ \$0	
Fabric/Vinyl Grade 2	FG2/VG2	+ \$34	
Fabric/Vinyl Grade 3	FG3/VG3	+ \$74	
Fabric/Vinyl Grade 4	FG4/VG4	+ \$121	
Fabric/Vinyl Grade 5	FG5/VG5	+ \$174	
Fabric/Vinyl Grade 6	FG6/VG6	+ \$235	
Fabric/Vinyl Grade 7	FG7/VG7	+ \$296	

Please reference the *Textile Reference Guide* for pricing on fabric over grade 7.

7. Packaging

Packaging	Code	Price	
Back Attached to Seat, Base Separate	UC	+ \$0	
Fully Assembled in Carton	AC	+ \$120	

RELAY

GSA SIN #: 33721

LIGHT TASK CHAIR AND TASK STOOL

SPECIFICATIONS

	94T Light Task Chair	94B S1 Light Task Stool	94B S2 Extended Light Task Stool
Overall Width	26"	26"	26"
Overall Depth	26"	26"	26"
Overall Height	32.25"-37.25"	35.25"	39.25"
Seat Width	18.25"	20.5"	20.5"
Seat Depth	17.25"	18"	18"
Seat Height	17"-22"	20.625"-27"	23.5"-33.50"
Back Width	19.125"	19.125"	19.125"
Back Height	17"	17"	17"
Weight Armless	27 lb	31 lb	32 lb
Weight With Arms	28 lb	32 lb	33 lb
COM	0.75 yd (US) 1 yd (UP)	0.75 yd (US) 1 yd (UP)	0.75 yd (US) 1 yd (UP)
Weight Capacity Warranty	250 lb	250 lb	250 lb

Upholstered seat (US). Upholstered seat and back (UP).



Best

Rio

LIGHT TASK CHAIR AND TASK STOOL

Design that responds to you.

What goes into the award-winning line of Rio® plastic chairs? Patented flexing technology, for one.

Our complete family of Rio models feature our patented Active Rebound Control (ARC) Technology®—a performance-minded flexor insert that supports a wide range of motion (20 full degrees to be exact) and responds precisely to the amount of weight pressed against it.

Add a fresh, modern color palette and you've got a seating solution that allows for more movement, day-long comfort and flexibility than any other chair in its class.



Featured Models

GOOD :: \$344

Light task chair, plastic seat and back, basic mechanism, armless, black frame, black base, carpet casters

BETTER :: \$402

Light task chair, upholstered seat and plastic back, basic mechanism, armless, black frame, black base, carpet casters, grade 1 textile

BEST :: \$553

Light task chair, upholstered seat and back, basic mechanism, fixed arms, silver frame, fog base, carpet casters, grade 1 textile



Features

- Exceptional support and comfort
- Fully upholstered, upholstered seat or plastic
- ARC Technology® for weight-assisted flex
- 14 plastic shell colors
- Two frame finishes with matching arm pads
- Easy-grip edge that acts as a pull handle
- Clean-out space
- 300 lb weight capacity warranty
- Complements Rio multipurpose chair counter and bar stool; see page 249

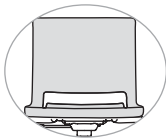
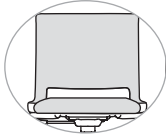
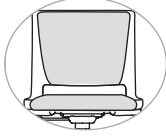
1. Back

Back and Seat Style	Code	Price	
Plastic Seat and Back	PS	\$344	
Upholstered Seat Only	US	\$402	
Upholstered Seat and Back	UP	\$460	

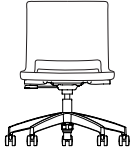
2. Frame

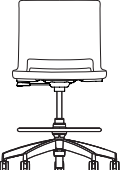

Frame Type	Code	Price	
Task Chair	1052 FT3	+ \$0	
Task Stool	1052 FT3 S21	+ \$132	
Extended Task Stool	1052 FT3 S22	+ \$156	

Frame Finish	Code	Price	
Black	FC1	+ \$0	
Silver	FC2	+ \$35	

Rio task models available with basic (swivel) mechanism only.



3. Arms

Arm Style	Code	Price	
Armless	A0	+ \$0	
Fixed	A91	+ \$58	

Arms, if specified, are black for black frames and fog for silver frames.

4. Base

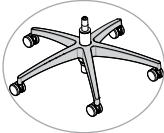
Base Color and Material	Code	Price	
Black Nylon Base (For Black Frame FC1)	B17	+ \$0	
Fog Nylon Base (For Silver Frame FC2)	B21	+ \$0	

Casters or Glides	Code	Price	
Casters			

Carpet Casters	C15	+ \$0	
Hard Floor and Carpet Casters	C14	+ \$40	
Self-Locking Carpet Casters	C20	+ \$30	
Self-Locking Hard Floor and Carpet Casters	C19	+ \$64	

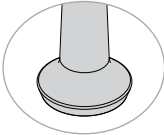
Glides			
Glides for Task Chairs	C3	+ \$30	

Self-locking casters (C19/C20) lock only when chair is not in use.

LIGHT TASK CHAIR AND TASK STOOL

5. Material

Protection	Code	Price	
CAL 133, Fabric, Quantities 1-49	133F	+ \$64	
CAL 133, Fabric, Quantities 50+	133F5	+ \$20	
CAL 133, Plastic, Any Quantity	133P	+ \$10	

Shell Color (For PS and US)	Code	Price	
Apple	SC24	+ \$0	
Arctic	SC21	+ \$0	
Bisque	SC7	+ \$0	
Black	SC1	+ \$0	
Chocolate	SC4	+ \$0	
Lagoon	SC15	+ \$0	
Latte	SC20	+ \$0	
Lemon	SC25	+ \$0	
Navy	SC5	+ \$0	
Pacific	SC22	+ \$0	
Red	SC19	+ \$0	
Slate	SC8	+ \$0	
Sterling	SC18	+ \$0	
Tangerine	SC23	+ \$0	

Textile	Code	Price	
Seat Textile Only (For US)			
COM	COM	+ \$0	
Fabric/Vinyl Grade 1	FG1/VG1	+ \$0	
Fabric/Vinyl Grade 2	FG2/VG2	+ \$22	
Fabric/Vinyl Grade 3	FG3/VG3	+ \$45	
Fabric/Vinyl Grade 4	FG4/VG4	+ \$77	
Fabric/Vinyl Grade 5	FG5/VG5	+ \$116	
Fabric/Vinyl Grade 6	FG6/VG6	+ \$159	
Fabric/Vinyl Grade 7	FG7/VG7	+ \$200	

Seat and Back Textile (UP)			
COM	COM	+ \$0	
Fabric/Vinyl Grade 1	FG1/VG1	+ \$0	
Fabric/Vinyl Grade 2	FG2/VG2	+ \$34	
Fabric/Vinyl Grade 3	FG3/VG3	+ \$74	
Fabric/Vinyl Grade 4	FG4/VG4	+ \$121	
Fabric/Vinyl Grade 5	FG5/VG5	+ \$174	
Fabric/Vinyl Grade 6	FG6/VG6	+ \$235	
Fabric/Vinyl Grade 7	FG7/VG7	+ \$296	

Please reference the Textile Reference Guide for pricing on fabric over grade 7.

6. Packaging

Packaging	Code	Price
Back Attached to Seat, Base Separate	UC	+ \$0
Fully Assembled in a Carton	AC	+ \$120

SPECIFICATIONS

	1052 Light Task Chair	1052 S21 Light Task Stool	1052 S22 Extended Light Task Stool
Overall Width	27"	27"	27"
Overall Depth	27"	27"	27"
Overall Height	31.9"-36.9"	37.9"-45.9"	41.9"-51.9"
Seat Width	18.5"	18.5"	18.5"
Seat Depth	18.2"	18.2"	18.2"
Seat Height	16.62"-21.75"	18"-26"	23"-33"
Back Width	17.5"	17.5"	17.5"
Back Height	18.2"	18.2"	18.2"
Weight Armless	20.5 lb	25.1 lb	26 lb
Weight With Arms	22.2 lb	26.8 lb	27.7 lb
COM	0.85 yd (US) 1 yd (UP)	0.85 yd (US) 1 yd (UP)	0.85 yd (US) 1 yd (UP)
Weight Capacity Warranty	300 lb	300 lb	300 lb

Upholstered seat (US). Upholstered seat and back (UP).



Best

Sona

CONFERENCE CHAIR

Meet in harmony.

Create contemporary conference rooms with the distinct style of Sona™. This up-to-any-task chair surrounds your tables with smart, sleek and slim lines while powering productivity with essential ergonomic engineering.



Featured Models

GOOD :: \$694

Knit back, swivel-tilt mechanism, open loop black arms, black nylon base, grade 1 textile

BETTER :: \$787

Knit-back, knee-tilt mechanism, fully adjustable black arms (6-way), black nylon base, grade 1 textile

BEST :: \$1,003

Upholstered back, enhanced synchro mechanism, open loop silver metallic arms, silver metallic base, silver metallic pull handle, grade 1 textile



Features

- Settle in with lumbar curve and height-adjustable back
- Add style and texture with 11 airy knit meshes
- 300 lb weight capacity warranty

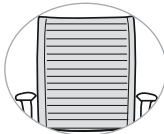
1. Back

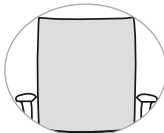

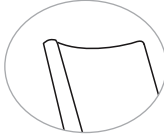
Back Size and Style	Code	Price	
Knit Back	5723 B7	\$787	

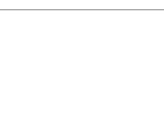
Upholstered Back	5723 B8	\$787	
------------------	---------	-------	--

Back Options	Code	Price	
No Pull Handle	PH0	+\$0	
Black Nylon Pull Handle	PH1	+\$26	
Silver Metallic Pull Handle	PH2	+\$32	

CONFERENCE CHAIR



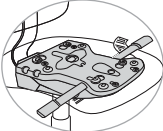

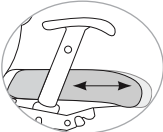
2. Mechanism

Mechanism	Code	Price	
Swivel-Tilt	T	-\$33	
Knee-Tilt	K	+\$0	
Enhanced Synchro	Y	+\$57	

Seat-Depth Adjustment	Code	Price	
Seat-Depth Adjustment	E3	+\$79	

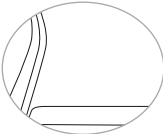
Seat-depth adjustment available with enhanced synchro (Y) mechanism only.

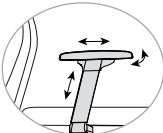
3. Arms

Arm Style	Code	Price	
Armless	A0	-\$135	
Fixed Black Open Loop	A111	-\$60	
Fixed Silver Metallic Open Loop	A112	+\$14	
Fully Adjustable Black (6-Way)	AR8	+\$0	

4. Base

Base Color and Material	Code	Price	
Black Nylon Base	B0	+ \$0	
Silver Metallic Base	B10	+ \$113	
Polished Aluminum Base	B3	+ \$113	
Brushed Aluminum Base	B25	+ \$113	
Low Profile Base With Higher Cylinder	S8	+ \$0	

High cylinder with low profile base (S8) is available with enhanced synchro (Y) mechanism only.



Good

CONFERENCE CHAIR

4. Base (Cont.)

Casters or Glides	Code	Price	
Casters			
Carpet Casters	C16	+ \$0	
Hard Floor and Carpet Casters	C17	+ \$40	
Self-Locking Carpet Casters	C20	+ \$30	
Self-Locking Hard Floor and Carpet Casters	C19	+ \$64	

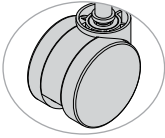
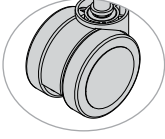
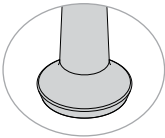
Casters or Glides	Code	Price	
Casters for Low Profile Base With Higher Cylinder (S8)			
Carpet Casters	C21	+ \$0	
Hard Floor and Carpet Casters	C22	+ \$40	
Glides			
Glides for Task Chairs	C3	+ \$30	

Self-locking casters (C19/C20) lock only when chair is not in use.

5. Material

Protection	Code	Price	
CAL 133, Fabric, Quantities 1-49	133F	+ \$99	
CAL 133, Fabric, Quantities 50+	133F5	+ \$55	
CAL 133, Leather, Any Quantity	133L	+ \$119	
Knit Color	Code	Price	
Textured Knit			
Black	KP10	+ \$0	
Cool Gray	KP11	+ \$0	
Dune	KP13	+ \$0	
Forest	KP14	+ \$0	
Merlot	KP16	+ \$0	
Mocha	KP12	+ \$0	
Ocean	KP15	+ \$0	
Twin Knit			
Licorice	KP23	+ \$0	
Shadow	KP22	+ \$0	
Toffee	KP20	+ \$0	
Winter Gray	KP21	+ \$0	
Textile (For Both B7 and B8)	Code	Price	
COM	COM	+ \$0	
Fabric/Vinyl Grade 1	FG1/VG1	+ \$0	
Fabric/Vinyl Grade 2	FG2/VG2	+ \$34	
Fabric/Vinyl Grade 3	FG3/VG3	+ \$74	
Fabric/Vinyl Grade 4	FG4/VG4	+ \$121	
Fabric/Vinyl Grade 5	FG5/VG5	+ \$174	
Fabric/Vinyl Grade 6	FG6/VG6	+ \$235	
Fabric/Vinyl Grade 7	FG7/VG7	+ \$296	
COL	COL	+ \$260	
Leather Grade 1	LG1	+ \$260	
Leather Grade 2	LG2	+ \$320	
Leather Grade 3	LG3	+ \$400	

Please reference the *Textile Reference Guide* for pricing on fabric over grade 7 and leather over grade 3.

6. Packaging

Packaging	Code	Price	
Knocked Down	KD	+ \$0	
Back Attached to Seat, Base Separate	UC	+ \$80	
Fully Assembled in a Carton	AC	+ \$200	

CONFERENCE CHAIR

SPECIFICATIONS

	5723 Conference Chair
Overall Width	27"
Overall Depth	25"
Overall Height	37"-43.5"
Seat Width	19"
Seat Depth	18"
Seat Height	17.5"-20.5"
Back Width	19"
Back Height	25"
Weight Armless	46 lb
Weight With Arms	52 lb
COM	1 yd (B7) 1.75 yd (B8)
COL	17 sq ft (B7) 32 sq ft (B8)
Weight Capacity Warranty	300 lb

Knit back (B7). Upholstered back (B8).



Better

Torsa

TASK CHAIR

Inspired by nature.

Cutting-edge design and the ability to personalize frame, arm, and mesh color combinations make Torsa™ the natural preference for a fresh, clean style. The innovative cable-driven synchro mechanism with Comfort Drive® allows easy fingertip adjustment from a seated position. And remarkably, excellent ergonomics come standard with adjustable lumbar support and seat-depth adjustment.



Featured Models

GOOD :: \$763

Enhanced synchro mechanism with Comfort Drive and seat-depth adjustment, fixed nylon arms, nylon base, grade 1 textile

BETTER :: \$803

Enhanced synchro mechanism with Comfort Drive and seat-depth adjustment, multi-adjustable nylon arms, nylon base, grade 1 textile

BEST :: \$969

Enhanced synchro mechanism with Comfort Drive and seat-depth adjustment, fixed polished aluminum arms, polished aluminum base, grade 1 textile

Features

- Cutting-edge design
- Comfortable and durable mesh back
- 10 bleach-cleanable mesh colors
- Four frame/arm/back support color combinations
- Enhanced synchro with Comfort Drive and seat-depth adjustment
- Adjustable lumbar support
- Textured control knobs
- Waterfall seat

1. Back

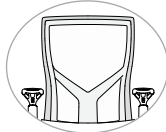
Back Size and Style	Code	Price	
Highback Mesh	6023	\$803	

2. Mechanism

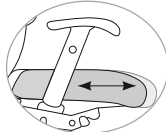
Mechanism	Code	Price	
Enhanced Synchro With Comfort Drive and Seat-Depth Adjustment	Y/E3	+ \$0	

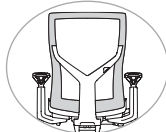

Seat-depth adjustment available with enhanced synchro (Y) mechanism only.

3. Frame

Frame Color	Code	Price	
Graphite	FC11	+ \$0	
White	FC12	+ \$0	
Back Support Color	Code	Price	
Graphite	Z3	+ \$0	
White	Z4	+ \$0	

TASK CHAIR

4. Arms

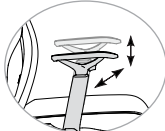
Arm Style	Code	Price	
Armless	A0	- \$78	
Fixed Nylon	A132	- \$40	
Fixed Polished Aluminum	A131	+ \$53	
Multi-Adjustable (Height/Width)	A134	+ \$0	

Arm color will match back support color. Fixed polished aluminum arms available with either back support color.

5. Base

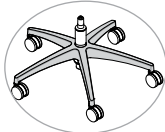
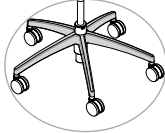
Base Color and Material	Code	Price	
Graphite Nylon Base (For Graphite Frame C11)	B14	+ \$0	
White Nylon Base (For White Frame FC12)	B20	+ \$0	
Polished Aluminum Base	B16	+ \$113	

Nylon bases must pair with their corresponding frame color. Polished aluminum base (B16) can be used with either frame color.

5. Base (Cont.)

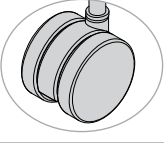
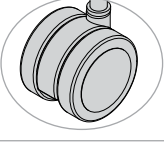
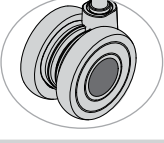
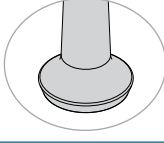
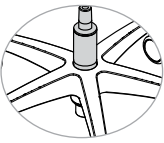
Casters or Glides	Code	Price	
Casters			
Carpet Casters	C25	+ \$0	
Hard Floor and Carpet Casters	C26	+ \$40	
Designer Casters	C30	+ \$119	
Glides			
Glides for Task Chairs	C3	+ \$30	
Cylinder Height			
Standard Cylinder	No Code	+ \$0	
Higher Cylinder	S13	+ \$0	

6. Material

Protection	Code	Price	
CAL 133, Fabric, Quantities 1-49	133F	+ \$99	
CAL 133, Fabric, Quantities 50+	133F5	+ \$55	
CAL 133, Leather, Any Quantity	133L	+ \$119	
Mesh Color			
Desert Solid Mesh	MC9	+ \$0	
Desert Striped Mesh	MC16	+ \$0	
Electric Blue Solid Mesh	MC13	+ \$0	
Fire Solid Mesh	MC10	+ \$0	
Fog Solid Mesh	MC7	+ \$0	
Fog Striped Mesh	MC15	+ \$0	
Navy Solid Mesh	MC8	+ \$0	
Nickel Solid Mesh	MC6	+ \$0	
Onyx Solid Mesh	MC5	+ \$0	
Onyx Striped Mesh	MC14	+ \$0	

TASK CHAIR

6. Material (Cont.)

Seat Textile	Code	Price	
COM	COM	+ \$0	
Fabric/Vinyl Grade 1	FG1/VG1	+ \$0	
Fabric/Vinyl Grade 2	FG2/VG2	+ \$26	
Fabric/Vinyl Grade 3	FG3/VG3	+ \$60	
Fabric/Vinyl Grade 4	FG4/VG4	+ \$116	
Fabric/Vinyl Grade 5	FG5/VG5	+ \$172	
Fabric/Vinyl Grade 6	FG6/VG6	+ \$213	
Fabric/Vinyl Grade 7	FG7/VG7	+ \$254	
COL	COL	+ \$300	
Leather Grade 1	LG1	+ \$300	
Leather Grade 2	LG2	+ \$380	
Leather Grade 3	LG3	+ \$480	

Please reference the *Textile Reference Guide* for pricing on fabric over grade 7 and leather over grade 3.



7. Packaging

Packaging	Code	Price
Knocked Down	KD	+ \$0
Back Attached to Seat, Base Separate	UC	+ \$80
Fully Assembled in a Carton	AC	+ \$200

SPECIFICATIONS

	6023 Highback Mesh Task Chair
Overall Width Armless	26"
Overall Width With Arms	27"
Overall Depth	27.125"
Overall Height	44.5"
Seat Width	19"
Seat Depth	18"-20.25"
Seat Height	17.36"-21.75" 19"-23.75" (S13)
Back Width	19"
Back Height	22"
Weight Armless	45 lb
Weight With Arms	50 lb
COM	1 yd
COL	17 sq ft
Weight Capacity Warranty	300 lb

Higher cylinder (S13).



TR2

TASK AND EXECUTIVE CHAIR

Ergonomics at work.

Classic ergonomic design and lifetime durability make the TR2™ a reliable task, executive/conference chair. Six control and comfort mechanisms plus seven arm options mean this chair is more versatile and comfortable than any other chair in its price range.



Best

Featured Models

GOOD :: \$621

Midback task, swivel-tilt mechanism, height-adjustable arms, black nylon base, carpet castes, grade 1 textile

BETTER :: \$747

Midback task, multi-function mechanism, height-adjustable arms, black nylon base, carpet castes, grade 1 textile

BEST :: \$836

Midback task, enhanced synchro mechanism, height-/width-adjustable arms with pivot, seat-depth adjustment, black nylon base, carpet castes, grade 1 textile

Features

- Internal back-height adjustment
- Six control mechanisms for motion and comfort
- Optional seat-depth adjustment
- Waterfall seat promotes proper leg circulation
- Seven arm styles
- Molded foam seat cushion
- CAL 133 approved models
- 300 lb weight capacity warranty;
350 lb Heavy Duty 24/7 weight capacity warranty

1. Back

Back Size and Style	Code	Price	
---------------------	------	-------	--

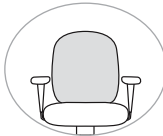
Midback Task	40	\$747	
--------------	----	-------	--

Highback Executive	40E	\$822	
--------------------	-----	-------	---

Back Options	Code	Price	
--------------	------	-------	--

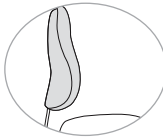
Upholstered Back	N	+\$0	
------------------	---	------	---

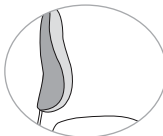
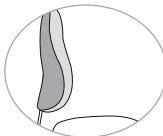
Plastic Back for Task	E4	+\$0	
Plastic Back for Executive	E5	+\$0	

Plastic back (E4/E5) requires posture back (P) or multi-function (M) mechanism.

TASK CHAIR

2. Heavy Duty

Heavy Duty Series	Code	Price	
-------------------	------	-------	--

Heavy Duty	HD	+\$126	
------------	----	--------	---

Available with enhanced synchro (Y) or multi-function (M) mechanism only. See page 38 for additional LT and HD options.

3. Seat

Seat Options	Code	Price	
--------------	------	-------	--

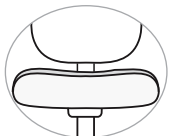
1" Additional Foam	F1	+\$36	
--------------------	----	-------	---

4. Mechanism

Mechanism	Code	Price	
-----------	------	-------	--

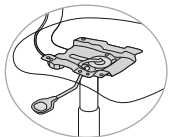
Basic (Swivel Only)	B	-\$169	
---------------------	---	--------	--

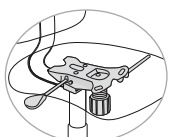
Swivel-Tilt	T	-\$126	
-------------	---	--------	---

Posture Back	P	-\$54	
--------------	---	-------	---

Enhanced Synchro	Y	-\$36	
------------------	---	-------	---

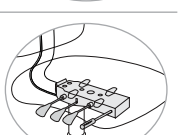
Multi-Function	M	+\$0	
----------------	---	------	---

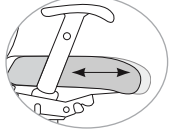

Basic mechanism (B) not available on highback executive model (40E).

4. Mechanism (Cont.)

Seat-Depth Adjustment	Code	Price	
Seat-Depth Adjustment	E3	+\$79	

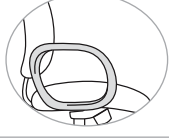

Seat-depth adjustment not available on basic (B) or swivel-tilt (T) mechanism.

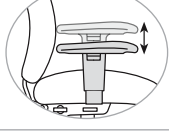
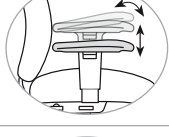
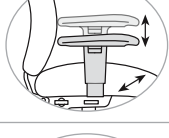
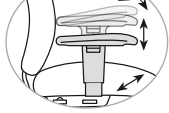
5. Arms

Arm Style	Code	Price	
Armless	A0	-\$110	
Fixed Loop	A2	-\$35	
Fixed Pad	A12	-\$35	
Height-Adjustable	A15	+\$0	
Height-Adjustable With Pivot	A43	+\$10	
Height-/Width-Adjustable	A17	+\$36	
Height-/Width-Adjustable With Pivot	A44	+\$46	

TASK CHAIR

6. Base

Base Color and Material	Code	Price	
Black Nylon Base	B0	+\$0	
Heavy Duty Black Nylon Base, 26"	B7	+\$0	

Brushed Aluminum Base	B2	+\$113	
-----------------------	----	--------	---

Casters or Glides	Code	Price	
Casters (For Black Base Only)			

Carpet Casters	C5	+\$0	
Hard Floor and Carpet Casters	C1	+\$40	

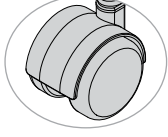
Self-Locking Carpet Casters	C2	+\$30	
-----------------------------	----	-------	---

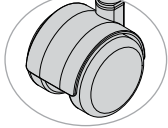
Self-Locking Hard Floor and Carpet Casters	C7	+\$61	
--	----	-------	---

Heavy Duty Casters

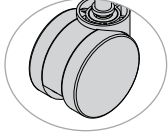
Heavy Duty Carpet Casters	C11	+\$0	
---------------------------	-----	------	---

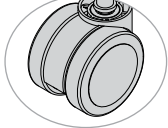
Heavy Duty Hard Floor and Carpet Casters	C9	+\$61	
--	----	-------	---

Glides

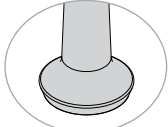
Glides for Task Chairs	C3	+\$30	
------------------------	----	-------	---

Glides (C3) are for black base only. Self-locking casters (C2/C7) lock only when chair is not in use.

6. Base (Cont.)

Cylinder Height	Code	Price	
Cylinder Extension Kit	S3	+ \$89	

Cylinder extension kit (S3) is only available with basic (B) or posture back (P) mechanisms.

7. Material

Protection	Code	Price	
CAL 133, Fabric, Quantities 1-49	133F	+ \$99	
CAL 133, Fabric, Quantities 50+	133F5	+ \$55	
Ballistic Nylon Back	Code	Price	
Ballistic Nylon Back	BN	+ \$0	
Seat and Back Textile	Code	Price	
COM	COM	+ \$0	
Fabric/Vinyl Grade 1	FG1/VG1	+ \$0	
Fabric/Vinyl Grade 2	FG2/VG2	+ \$34	
Fabric/Vinyl Grade 3	FG3/VG3	+ \$74	
Fabric/Vinyl Grade 4	FG4/VG4	+ \$121	
Fabric/Vinyl Grade 5	FG5/VG5	+ \$174	
Fabric/Vinyl Grade 6	FG6/VG6	+ \$235	
Fabric/Vinyl Grade 7	FG7/VG7	+ \$296	
COL	COL	+ \$340	
Leather Grade 1	LG1	+ \$340	
Leather Grade 2	LG2	+ \$460	
Leather Grade 3	LG3	+ \$600	

Please reference the Textile Reference Guide for pricing on fabric over grade 7 and leather over grade 3.

8. Packaging

Packaging	Code	Price	
Knocked Down	KD	+ \$0	
Back Attached to Seat, Base Separate	UC	+ \$80	
Fully Assembled in a Carton	AC	+ \$200	

SPECIFICATIONS

	40 Midback Task	40E Highback Executive
Overall Width	26"	26"
Overall Depth	26"	26"
Overall Height	36"	40.5"
Seat Width	20"	21"
Seat Depth	18"	20"
Seat Height	16.5"-21"	16.5"-21"
Back Width	18"	20"
Back Height	19.5"	24"
Weight Armless	38 lb (B)	N/A (B)
	41 lb (T)	44 lb (T)
	42 lb (P)	45 lb (P)
	45 lb (Y)	45 lb (Y)
	48 lb (M)	51 lb (M)
Weight With Arms	43 lb (B)	N/A (B)
	46 lb (T)	49 lb (T)
	47 lb (P)	50 lb (P)
	50 lb (Y)	50 lb (Y)
	47 lb (M)	56 lb (M)
COM	1.5 yd	2 yd
	1.25 yd (BN)	1.7 yd (BN)
COL	25 sq ft	36 sq ft
	20 sq ft (BN)	30 sq ft (BN)
Weight Capacity Warranty	300 lb	300 lb
	350 lb (Y/M) (HD)	350 lb (Y/M) (HD)

Basic mechanism (B). Swivel-tilt mechanism (T). Posture back mechanism (P). Enhanced synchro mechanism (Y). Multi-function mechanism (M). Ballistic nylon back (BN).

TR2

TASK STOOL

Ergonomics at work.

The efficient, modest lines of the TR2 collection mimic the state of business: robust, reliable and not wasting a single step. Three control and comfort mechanisms plus six arm options create a multitude of customization opportunities that make this classic task stool more versatile and comfortable than any other in its price range.



Best

Featured Models

GOOD :: \$571

Midback stool, basic mechanism, armless, standard stool kit, black nylon base, carpet casters, grade 1 textile

BETTER :: \$796

Midback stool, posture back mechanism, height-adjustable arms, standard stool kit, black nylon base, carpet casters, grade 1 textile

BEST :: \$856

Midback stool, posture back mechanism, height-/width-adjustable arms, extended stool kit, black nylon base, carpet casters, grade 1 textile

Features

- Three control mechanisms for motion and comfort
- Waterfall seat
- Six arm styles
- Molded foam seat cushion
- 300 lb weight capacity warranty;
350 lb Heavy Duty 24/7 weight capacity warranty

1. Back

Back Size and Style	Code	Price	
---------------------	------	-------	--

Midback Task

40

\$796

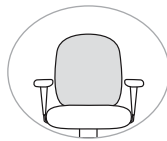

Back Options	Code	Price	
--------------	------	-------	--

Upholstered Back

N

+ \$0

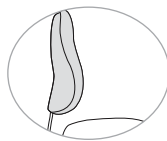

Plastic Back for Task

E4

+ \$0

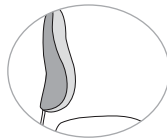

Plastic back (E4) requires posture back (P) mechanism.

2. Heavy Duty

Heavy Duty Series	Code	Price	
-------------------	------	-------	--

Heavy Duty

HD

+ \$191



Heavy Duty mechanism (HD) requires heavy duty stool kit (S1HD/S2HD). See page 38 for additional LT and HD options.

TASK STOOL

3. Seat

Seat Options	Code	Price	
--------------	------	-------	--

1" Additional Foam

F1

+ \$36

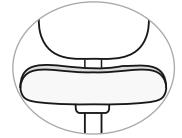

4. Mechanism

Mechanism Style	Code	Price	
-----------------	------	-------	--

Basic (Swivel Only)

B

- \$115

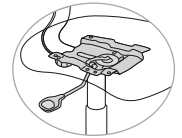

Posture Back



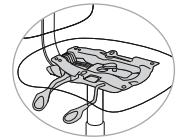

P

+ \$0



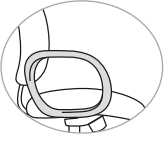
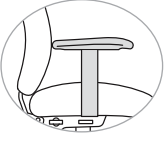

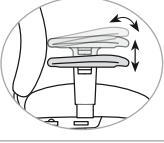
Good

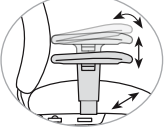
5. Arms

Arm Style	Code	Price	
Armless	A0	- \$110	
Fixed Loop	A2	- \$35	
Fixed Pad	A12	- \$35	
Height-Adjustable	A15	+ \$0	
Height-Adjustable With Pivot	A43	+ \$10	
Height-/Width-Adjustable	A17	+ \$36	
Height-/Width-Adjustable With Pivot	A44	+ \$46	

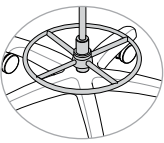
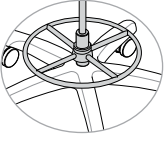
6. Base

Base	Code	Price	
Standard Stool Kit	S1	+ \$0	
Extended Stool Kit	S2	+ \$24	
Heavy Duty Stool Kit	S1HD	+ \$0	
Heavy Duty Extended Stool Kit	S2HD	+ \$24	

TASK STOOL

6. Base (Cont.)

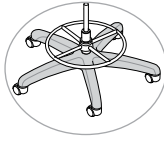
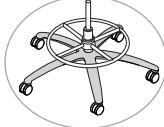
Base Color and Material	Code	Price	
Black Nylon Base	B0	+ \$0	
Brushed Aluminum Base	B2	+ \$113	

Casters or Glides	Code	Price	
Casters (For Black Base Only)			

Black Carpet Casters	C5	+ \$0	
Hard Floor and Carpet Casters	C1	+ \$40	
Self-Locking Carpet Casters	C2	+ \$30	
Self-Locking Hard Floor and Carpet Casters	C7	+ \$61	

Heavy Duty Casters

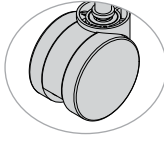
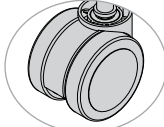
Heavy Duty Carpet Casters	C11	+ \$0	
Heavy Duty Hard Floor and Carpet Casters	C9	+ \$61	

Glides

Glides for Task Chairs	C3	+ \$30	
------------------------	----	--------	---

Self-locking casters (C2/C7) lock only when chair is not in use.

7. Material

Protection	Code	Price	
CAL 133, Fabric, Quantities 1–49	133F	+ \$99	
CAL 133, Fabric, Quantities 50+	133F5	+ \$55	
CAL 133, Leather, Any Quantity	133L	+ \$119	
Ballistic Nylon	Code	Price	
Ballistic Nylon Back	BN	+ \$0	
Seat and Back Textile	Code	Price	
COM	COM	+ \$0	
Fabric/Vinyl Grade 1	FG1/VG1	+ \$0	
Fabric/Vinyl Grade 2	FG2/VG2	+ \$34	
Fabric/Vinyl Grade 3	FG3/VG3	+ \$74	
Fabric/Vinyl Grade 4	FG4/VG4	+ \$121	
Fabric/Vinyl Grade 5	FG5/VG5	+ \$174	
Fabric/Vinyl Grade 6	FG6/VG6	+ \$235	
Fabric/Vinyl Grade 7	FG7/VG7	+ \$296	
COL	COL	+ \$340	
Leather Grade 1	LG1	+ \$340	
Leather Grade 2	LG2	+ \$460	
Leather Grade 3	LG3	+ \$600	

Please reference the *Textile Reference Guide* for pricing on fabric over grade 7 and leather over grade 3.

8. Packaging

Packaging	Code	Price	
Knocked Down	KD	+ \$0	
Back Attached to Seat, Base Separate	UC	+ \$80	
Fully Assembled in a Carton	AC	+ \$200	

SPECIFICATIONS

	40 S1 Task Stool	40 S2 Extended Task Stool
Overall Width	27"	27"
Overall Depth	27"	27"
Overall Height	39"	43"
Seat Width	20"	20"
Seat Depth	19" 18" (HD)	18" 18" (HD)
Seat Height	19"–27" (B) 19.5"–27.5" (P)	23"–33" (B) 23.5"–33.5" (P)
Back Width	18"	18"
Back Height	21"	21"
Weight Armless	42 lb (B) 45 lb (P) 43 lb (B2)(HD)	43 lb 43 lb (B2)(HD)
Weight With Arms	45 lb (B) 50 lb (P) 48 lb (B2) (HD)	48 lb 48 lb (B2) (HD)
COM	1.5 yd 1.25 yd (BN)	1.5 yd 1.25 yd (BN)
COL	25 sq ft 20 sq ft (BN)	25 sq ft 20 sq ft (BN)
Weight Capacity Warranty	300 lb 350 lb (HD)	300 lb 350 lb (HD)

Heavy Duty model (HD). Basic mechanism (B). Posture back mechanism (P). Heavy Duty mechanism (B2). Ballistic nylon back (BN).

Vectra

MESH BACK TASK CHAIR

Experience beyond.

Meet our most advanced product yet. Vectra™ is next-gen intelligent design with smart features promising smarter solutions. It's a super-slim, precision-engineered package built to deliver robust on-demand comfort and the kind of cutting-edge innovation that redefines an entire category.



Featured Models

GOOD :: \$704

Highback mesh with enhanced synchro mechanism, adjustable lumbar, graphite frame, height-adjustable arms, graphite nylon base, carpet casters, grade 1 textile

BETTER :: \$797

Highback mesh with advanced synchro mechanism with seat-depth adjustment, adjustable lumbar, graphite frame, height-adjustable arms, graphite nylon base, carpet casters, grade 1 textile

BEST :: \$892

Highback mesh with advanced synchro mechanism with seat-depth adjustment, adjustable lumbar, fog frame, fully adjustable (8-way) arms, fog nylon base, carpet casters, grade 1 textile

Features

- Activate proprietary lumbar tension and support with quick-adjust slide knobs
- Five tilt-limiter back positions for comfort in various activities
- Seat tension adjusts quickly in less than two revolutions
- Match performance casters and base to three different frame colors
- 6 colors of ultra-sheer micro mesh
- Customizable arm triggers, caster rings and lumbar adjustment carriage with 13 accent colors
- Energizing ergonomics from advanced synchro mechanism and cantilever arms
- Aerodynamic flair with low-profile arms and slim graphite arm pads

1. Back

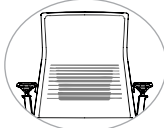

Back Size and Style	Code	Price	
Highback Mesh With Adjustable Lumbar Support	1073 BK2 MB	\$797	

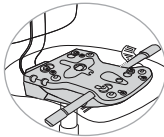
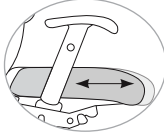
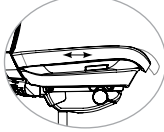
2. Mechanism

Mechanism Style	Code	Price	
Enhanced Synchro	Y	- \$93	
Enhanced Synchro With Seat-Depth Adjustment	Y/E3	- \$46	
Advanced Synchro With Seat-Depth Adjustment	L/E3	+ \$0	

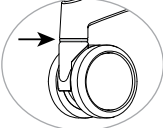

MESH BACK TASK CHAIR

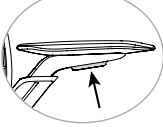
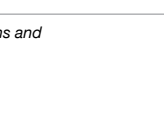
3. Frame

Frame Color	Code	Price	
Graphite	FC11	+\$0	
White	FC12	+\$35	
Fog	FC13	+\$35	
Accent Color	Code	Price	
Apple	LA12	+ \$0	
Desert	LA3	+ \$0	
Electric Blue	LA5	+ \$0	
Fire	LA6	+ \$0	
Fog	LA4	+ \$0	
Graphite	LA14	+ \$0	
Lemon	LA8	+ \$0	
Navy	LA15	+ \$0	
Nickel	LA2	+ \$0	
Onyx	LA1	+ \$0	
Platinum	LA16	+ \$0	
Tangerine	LA9	+ \$0	
White	LA13	+ \$0	

Accent color applies to lumbar adjustment, arm adjustment buttons and caster rings.

4. Arms

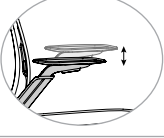
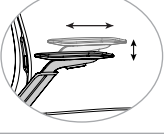
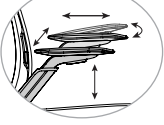
Arm Style	Code	Price	
Armless	AR0	- \$48	
Fixed Arms (Coming Soon!)	AR2	- \$10	
Height-Adjustable	AR4	+ \$0	
Height-/Width-Adjustable	AR6	+ \$30	
Fully Adjustable (8-Way)	AR9	+ \$60	

5. Base

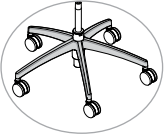
Base Color and Material	Code	Price	
Graphite Nylon Base (For Graphite Frame FC11)	B14	+ \$0	
Fog Nylon Base (For Fog Frame FC13)	B21	+ \$0	
White Nylon Base (For White Frame FC12)	B20	+ \$0	
Polished Aluminum Base	B18	+ \$113	

Nylon base color must match frame color. Aluminum base (B18) can be used with any frame color. Polished aluminum base (B18) is not available with lower cylinder (CH4).

MESH BACK TASK CHAIR

5. Base (Cont.)

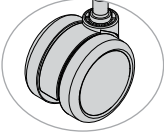
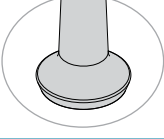
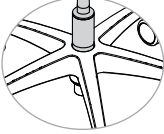
Casters or Glides	Code	Price	
Casters			
Carpet Casters	CS5	+ \$0	
Hard Floor and Carpet Casters	CS6	+ \$40	
Glides			
Glides for Task Chairs	CS3	+ \$30	
Cylinder Height			
Standard Cylinder	CH1	+ \$0	
Higher Cylinder	CH3	+ \$0	
Lower Cylinder	CH4	+ \$0	

Caster color coordinates with frame color. Lower cylinder (CH4) is not available with polished aluminum base (B18).

6. Material

Mesh Color	Code	Price	
Desert	MC9	+ \$0	
Mist	MC41	+ \$0	
Navy	MC8	+ \$0	
Nickel	MC6	+ \$0	
Onyx	MC5	+ \$0	
Platinum	MC42	+ \$0	
Seat Textile			
COM	COM	+ \$0	
Fabric/Vinyl Grade 1	FG1/VG1	+ \$0	
Fabric/Vinyl Grade 2	FG2/VG2	+ \$26	
Fabric/Vinyl Grade 3	FG3/VG3	+ \$60	
Fabric/Vinyl Grade 4	FG4/VG4	+ \$116	
Fabric/Vinyl Grade 5	FG5/VG5	+ \$172	
Fabric/Vinyl Grade 6	FG6/VG6	+ \$213	
Fabric/Vinyl Grade 7	FG7/VG7	+ \$254	
COL	COL	+ \$300	
Leather Grade 1	LG1	+ \$300	
Leather Grade 2	LG2	+ \$380	
Leather Grade 3	LG3	+ \$480	

Please reference the Textile Reference Guide for pricing on fabric over grade 7 and leather over grade 3.

7. Packaging

Packaging	Code	Price
Knocked Down	KD	+ \$0
Back Attached to Seat, Base Separate	UC	+ \$80
Fully Assembled in a Carton	AC	+ \$200

SPECIFICATIONS

	1073.BK2.MB Highback Mesh Task Chair
Overall Width Armless	26"
Overall Width With Arms	27"
Overall Depth	25"
Overall Height	38" (L/E3), 38.5" (Y/E3)
Seat Width	19.75"
Seat Depth	17"
Seat Height Short Cylinder	15.5"–17.63" (L/E3) 16"–18.1" (Y/E3)
Seat Height Standard Cylinder	16.5"–20.75" 17"–21.25" (Y/E3)
Seat Height High Cylinder	18.25"–22.63" (L/E3), 18.75"–23.1" (Y/E3)
Back Width	20.5"
Back Height	23"
Weight Armless	30 lb
Weight With Arms	33 lb (L/E3), 41 lb (Y/E3)
COM	1.1 yd
COL	20 sq ft
Weight Capacity Warranty	300 lb

Enhanced synchro with seat-depth Adjustment (Y/E3). Advanced synchro with seat-depth adjustment (L/E3)



Better

Wit

MESH BACK TASK CHAIR

Work smarter.

Gone are the days where you clock in, stay in your cubicle and clock out. Dynamic environments call for adaptable seating that rolls with the punches. Our Wit™ family does exactly that. Because this is a design inspired by truths about how people work.

Today's ever-changing marketplace calls for flexibility. Teams need to be able to set up shop anywhere—and at any time. All of our Wit task models are easily adjustable so anyone can find a seat, settle in and get right to work.



Featured Models

GOOD :: \$458

Midback, swivel-tilt mechanism, height-adjustable arms, black frame, black nylon base, carpet casters, grade 1 textile

BETTER :: \$504

Highback, standard synchro mechanism, height-adjustable arms, black frame, black nylon base, carpet casters, grade 1 textile

BEST :: \$658

Highback, standard synchro mechanism with seat-depth adjustment, multi-adjustable arms, white frame and white nylon base, carpet casters, grade 1 textile



Features

- Midback and highback task chairs
- Standard adjustable lumbar support
- Built-in pull handle
- 12 solid mesh back colors
- Four woven striped mesh options
- Three frame colors
- Standard synchro, swivel-tilt and basic mechanisms
- Multi-adjustable (height/width), height-adjustable, armless and fixed arms
- Textured designer arms
- Optional seat-depth adjustment
- Optional brushed aluminum base
- Waterfall seat
- Standard 300 lb weight capacity warranty
- Complemented by Wit Side; see page 256

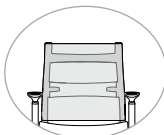
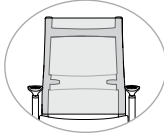
1. Back

Back Size and Style	Code	Price	
Midback Mesh With Adjustable Lumbar Support	2222 B1	\$476	
Highback Mesh With Adjustable Lumbar Support	2223 B1	\$504	

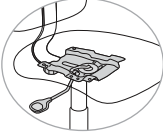
2. Mechanism

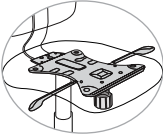
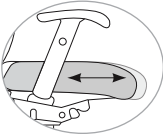
Mechanism	Code	Price	
Basic (Swivel Only)	B	- \$33	
Swivel-Tilt	T	- \$18	
Standard Synchro	F	+ \$0	
Seat-Depth Adjustment	Code	Price	
Seat-Depth Adjustment	E3	+ \$79	

Seat-depth adjustment (E3) available with standard synchro (F) mechanism only.

3. Frame

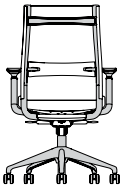
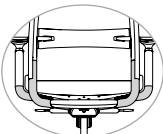

Frame Color	Code	Price	
Black	FC1	+ \$0	
White	FC12	+ \$45	
Fog	FC13	+ \$45	
Back Support Color	Code	Price	
Black (For Black Frame FC1)	Z1	+ \$0	
Silver (For Black Frame FC1)	Z2	+ \$0	
White (For White Frame FC12)	Z4	+ \$0	
Fog (For Fog Frame FC13)	Z7	+ \$0	

4. Arms

Arm Style	Code	Price	
Armless	A0	- \$48	
Fixed	A127	- \$10	
Height-Adjustable	A128	+ \$0	
Multi-Adjustable (Height/Width)	A129	+ \$30	

Arms, if specified, come with fog arm pads for the white and fog frames and black arm pads for the black frame.

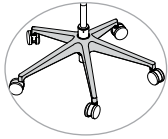
5. Base

Base Color and Material	Code	Price	
Black Nylon Base With Black Casters (For Black Frame FC1)	B0	+ \$0	
White Nylon Base With Fog/White Casters (For White Frame FC12)	B20	+ \$0	
Fog Nylon Base With Fog Casters (For Fog Frame FC13)	B21	+ \$0	
Brushed Aluminum Base	B8	+ \$113	
Heavy Duty Black Base, 26"	B7	+ \$0	

Heavy duty black base (B7) requires lower cylinder. Brushed aluminum base (B8) can be used with any frame color.

Brushed aluminum base (B8) with a standard synchro (F) mechanism requires a higher cylinder (S13).

MESH BACK TASK CHAIR

5. Base (Cont.)

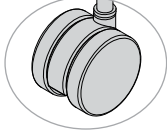
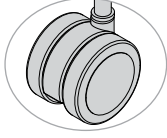
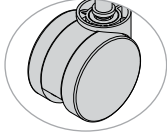
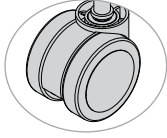
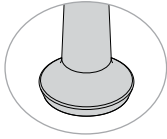
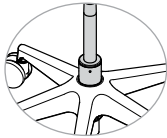
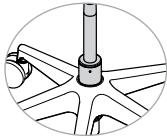
Casters or Glides	Code	Price	
Casters			
Black Carpet Casters (for Black Frame - FC1)	C16	+ \$0	
Black Hard Floor and Carpet Casters (For Black Frame FC1)	C17	+ \$40	
Hard Floor and Carpet Casters (For Fog or White Frame FC12/FC13)	CS6	+ \$0	
Heavy Duty Casters			
Heavy Duty Carpet Casters	C11	+ \$0	
Heavy Duty Hard Floor and Carpet Casters	C9	+ \$61	
Glides			
Glides for Task Chairs	C3	+ \$30	
Cylinder Height			
Standard Cylinder	S0	+ \$0	
Higher Cylinder	S13	+ \$0	
Lower Cylinder	S10	+ \$0	
Lower cylinder (S10) is available for Heavy Duty (HD) model only.			
6. Material			
Protection	Code	Price	
CAL 133, Fabric, Quantities 1-49	133F	+ \$99	
CAL 133, Fabric, Quantities 50+	133F5	+ \$55	
CAL 133, Leather, Any Quantity	133L	+ \$119	

6. Material (Cont.)

Mesh Color	Code	Price	
Solid Mesh			
Apple	MC31	+ \$0	
Aqua	MC30	+ \$0	
Desert	MC22	+ \$0	
Electric Blue	MC24	+ \$0	
Fire	MC25	+ \$0	
Fog	MC23	+ \$0	
Grape	MC26	+ \$0	
Lemon	MC27	+ \$0	
Nickel	MC21	+ \$0	
Ocean	MC29	+ \$0	
Onyx	MC20	+ \$0	
Tangerine	MC28	+ \$0	
Woven Striped Mesh			
Fog	MC37	+ \$0	
Frost	MC36	+ \$0	
Nickel	MC38	+ \$0	
Onyx	MC35	+ \$0	
Seat Textile	Code	Price	
COM	COM	+ \$0	
Fabric/Vinyl Grade 1	FG1/VG1	+ \$0	
Fabric/Vinyl Grade 2	FG2/VG2	+ \$26	
Fabric/Vinyl Grade 3	FG3/VG3	+ \$60	
Fabric/Vinyl Grade 4	FG4/VG4	+ \$116	
Fabric/Vinyl Grade 5	FG5/VG5	+ \$172	
Fabric/Vinyl Grade 6	FG6/VG6	+ \$213	
Fabric/Vinyl Grade 7	FG7/VG7	+ \$254	
COL	COL	+ \$300	
Leather Grade 1	LG1	+ \$300	
Leather Grade 2	LG2	+ \$380	
Leather Grade 3	LG3	+ \$480	

Please reference the *Textile Reference Guide* for pricing on fabric over grade 7 and leather over grade 3.

7. Packaging

Packaging	Code	Price	
Knocked Down	KD	+ \$0	
Back Attached to Seat, Base Separate	UC	+ \$80	
Fully Assembled in a Carton	AC	+ \$200	

MESH BACK TASK CHAIR**SPECIFICATIONS**

	2222 B1 Midback Mesh Task Chair	2223 B1 Highback Mesh Task Chair
Overall Width Armless	25"	25"
Overall Width With Arms	26"	26"
Overall Depth	25"	25"
Overall Height	36.75"	40.75"
Seat Width	20"	20"
Seat Depth	17.5"-19.5"	17.5"-19.5"
Seat Height	17.5"-21.25" (F/T) 16.63"-20.38" (B) 17.75"-21.5" (F/E3)	17.5"-21.25" (F/T) 16.63"-20.38" (B) 17.75"-21.5" (F/E3)
Seat Height With Higher Cylinder	19"-22.5" (F/T) 18"-21.5" (B) 19"-22.5" (F/E3)	19"-22.5" (F/T) 18"-21.5" (B) 19"-22.5" (F/E3)
Seat Height With Lower Cylinder (B7)	15"-18" (B) 15.5"-18.5" (T) 15.63"-18.68" (F) 16"-19" (F/E3)	15"-18" (B) 15.5"-18.5" (T) 15.63"-18.68" (F) 16"-19" (F/E3)
Back Width	18.75"	18.75"
Back Height	19"	23"
Weight Armless	30 lb	31 lb
Weight With Arms	36 lb	37 lb
COM	1 yd	1 yd
COL	17 sq ft	17 sq ft
Weight Capacity Warranty	300 lb	300 lb

Basic mechanism (B). Swivel-tilt mechanism (T). Standard synchro mechanism (F).
Seat-depth adjustment (E3).

Wit

MESH BACK TASK STOOL

Work smarter.

Gone are the days where you clock in, stay in your cubicle and clock out. Dynamic environments call for adaptable seating that rolls with the punches. Our Wit™ family does exactly that. Because this is a design inspired by truths about how people work.

Today's ever-changing marketplace calls for flexibility. Teams need to be able to set up shop anywhere—and at any time. All of our Wit task models are easily adjustable so anyone can find a seat, settle in and get right to work.



Featured Models

GOOD :: \$505

Midback mesh with adjustable lumbar, basic mechanism, armless, black frame, standard stool kit, carpet casters, grade 1 textile

BETTER :: \$553

Midback mesh with adjustable lumbar, basic mechanism, height-adjustable arms, black frame, standard stool kit, carpet casters, grade 1 textile

BEST :: \$652

Midback mesh with adjustable lumbar, basic mechanism, multi-adjustable arms, fog frame, extended stool kit, carpet casters, grade 1 textile

MESH BACK TASK STOOL

Features

- Midback task stool
- Standard adjustable lumbar support
- Built-in pull handle
- 12 solid mesh back colors
- Four woven striped mesh options
- Three frame colors
- Basic mechanism
- Multi-adjustable (height/width), height-adjustable, armless and fixed arms
- Textured designer arms
- Optional brushed aluminum base
- Waterfall seat
- Standard 300 lb weight capacity warranty
- Complemented by Wit Side; see page 256

1. Back

Back Size and Style	Code	Price	
Midback Mesh With Adjustable Lumbar Support	2222 B1	\$553	

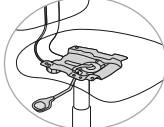

2. Mechanism

Mechanism	Code	Price	
Basic (Swivel Only)	B	+ \$0	

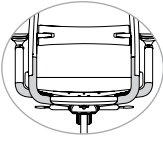
3. Frame

Frame Color	Code	Price	
Black	FC1	+ \$0	
White	FC12	+ \$45	
Fog	FC13	+ \$45	
Back Support Color	Code	Price	
Black (For Black Frame FC1)	Z1	+ \$0	
Silver (For Black Frame FC1)	Z2	+ \$0	
White (For White Frame FC12)	Z4	+ \$0	
Fog (For Fog Frame FC13)	Z7	+ \$0	

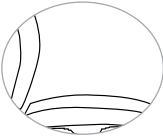
4. Arms

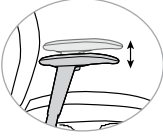
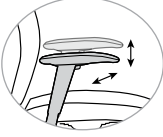
Arm Style	Code	Price	
Armless	A0	- \$48	
Fixed	A127	- \$10	
Height-Adjustable	A128	+ \$0	
Multi-Adjustable (Height/Width)	A129	+ \$30	

Arms, if specified, come with fog arm pads for the white and fog frames and black arm pads for the black frame.

5. Base

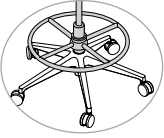
Base	Code	Price	
Stool Kit	S1	+ \$0	
Extended Stool Kit	S2	+ \$24	

Base Color and Material	Code	Price	
Black Nylon Base With Black Casters (For Black Frame FC1)	B0	+ \$0	
White Nylon Base With Fog/White Casters (For White Frame FC12)	B20	+ \$0	
Fog Nylon Base With Fog Casters (For Fog Frame FC13)	B21	+ \$0	

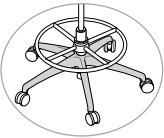
Brushed Aluminum Base	B8	+ \$113	
-----------------------	----	---------	---

Casters or Glides	Code	Price	
Casters			

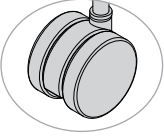
Black Carpet Casters (For Black Frame FC1)	C16	+ \$0	
---	-----	-------	---

Black Hard Floor and Carpet Casters (For Black Frame FC1)	C17	+ \$40	
--	-----	--------	---

Hard Floor and Carpet Casters (For Fog or White Frame FC12/FC13)	CS6	+ \$0
---	-----	-------

Glides			
---------------	--	--	--

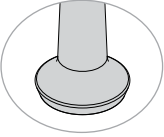
Glides for Task Chairs	C3	+ \$30	
------------------------	----	--------	---

Brushed aluminum base (B8) can be used with any frame color.

MESH BACK TASK STOOL

6. Material

Protection	Code	Price	
CAL 133, Fabric, Quantities 1-49	133F	+ \$99	
CAL 133, Fabric, Quantities 50+	133F5	+ \$55	
CAL 133, Leather, Any Quantity	133L	+ \$119	

Mesh Color	Code	Price	
Solid Mesh			
Apple	MC31	+ \$0	
Aqua	MC30	+ \$0	
Desert	MC22	+ \$0	
Electric Blue	MC24	+ \$0	
Fire	MC25	+ \$0	
Fog	MC23	+ \$0	
Grape	MC26	+ \$0	
Lemon	MC27	+ \$0	
Nickel	MC21	+ \$0	
Ocean	MC29	+ \$0	
Onyx	MC20	+ \$0	
Tangerine	MC28	+ \$0	

Woven Striped Mesh			
Fog	MC37	+ \$0	
Frost	MC36	+ \$0	
Nickel	MC38	+ \$0	
Onyx	MC35	+ \$0	

Seat Textile	Code	Price	
COM	COM	+ \$0	
Fabric/Vinyl Grade 1	FG1/VG1	+ \$0	
Fabric/Vinyl Grade 2	FG2/VG2	+ \$26	
Fabric/Vinyl Grade 3	FG3/VG3	+ \$60	
Fabric/Vinyl Grade 4	FG4/VG4	+ \$116	
Fabric/Vinyl Grade 5	FG5/VG5	+ \$172	
Fabric/Vinyl Grade 6	FG6/VG6	+ \$213	
Fabric/Vinyl Grade 7	FG7/VG7	+ \$254	
COL	COL	+ \$300	
Leather Grade 1	LG1	+ \$300	
Leather Grade 2	LG2	+ \$380	
Leather Grade 3	LG3	+ \$480	

Please reference the *Textile Reference Guide* for pricing on fabric over grade 7 and leather over grade 3.

MESH BACK TASK STOOL

7. Packaging

Packaging	Code	Price
Knocked Down	KD	+ \$0
Back Attached to Seat, Base Separate	UC	+ \$80
Fully Assembled in a Carton	AC	+ \$200

SPECIFICATIONS

	2222 B1 S1 Midback Mesh Task Stool	2222 B1 S2 Midback Mesh Extended Task Stool
Overall Width	27"	27"
Overall Depth	27"	27"
Overall Height	45.63"	50"
Seat Width	20"	20"
Seat Depth	17.5"	17.5"
Seat Height	22"-30"	26"-36"
Back Width	19"	19"
Back Height	18.75"	18.75"
Weight Armless	28.5 lb	29.5 lb
Weight With Arms	34.5 lb	35.5 lb
COM	1 yd	1 yd
COL	17 sq ft	17 sq ft
Weight Capacity Warranty	300 lb	300 lb



Better

Wit

THINTEX BACK TASK CHAIR

Work smarter.

Gone are the days where you clock in, stay in your cubicle and clock out. Dynamic environments call for adaptable seating that rolls with the punches. Our Wit™ family does exactly that. Because this is a design inspired by truths about how people work.

Today's ever-changing marketplace calls for flexibility. Teams need to be able to set up shop anywhere—and at any time. All of our Wit task models are easily adjustable so anyone can find a seat, settle in and get right to work.



Featured Models

GOOD :: \$524

Midback, swivel-tilt mechanism, height-adjustable arms, black frame, black nylon base, carpet casters, grade 1 textile

BETTER :: \$570

Highback, standard synchro mechanism, height-adjustable arms, black frame, black nylon base, carpet casters, grade 1 textile

BEST :: \$724

Highback, standard synchro mechanism, seat-depth adjustment, multi-adjustable (height/width) arms, white frame, white nylon base, carpet casters, grade 1 textile

Features

- Midback and highback task chairs
- Standard adjustable lumbar support
- Built-in pull handle
- 12 Thintex back colors in fabric or vinyl
- Three frame colors
- Standard synchro, swivel-tilt and basic mechanisms
- Multi-adjustable (height/width), height-adjustable, armless and fixed arms
- Textured designer arms
- Optional seat-depth adjustment
- Optional brushed aluminum base
- Waterfall seat
- Standard 300 lb weight capacity warranty
- Complemented by Wit Side; see page 260

1. Back

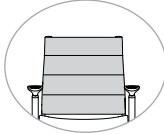
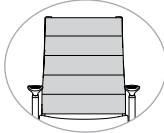
Back Size and Style	Code	Price	
Thintex Midback With Adjustable Lumbar Support	2222 B9	\$542	
Thintex Highback With Adjustable Lumbar Support	2223 B9	\$570	
Back Material	Code	Price	
Fabric	TX1	+ \$0	
Vinyl	TX2	+ \$0	

2. Mechanism

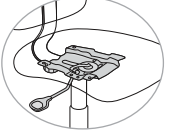
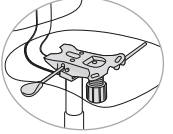
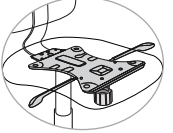
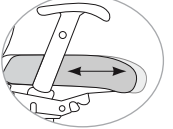

Mechanism Style	Code	Price	
Basic (Swivel Only)	B	- \$33	
Swivel-Tilt	T	- \$18	
Standard Synchro	F	+ \$0	
Seat-Depth Adjustment	Code	Price	
Seat-Depth Adjustment	E3	+ \$79	

Seat-depth adjustment (E3) available with standard synchro (F) mechanism only.

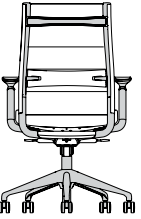
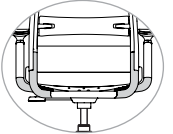
3. Frame



Frame Color	Code	Price	
Black	FC1	+ \$0	
White	FC12	+ \$45	
Fog	FC13	+ \$45	
Back Support Color	Code	Price	
Black (For Black Frame FC1)	Z1	+ \$0	
Silver (For Black Frame FC1)	Z2	+ \$0	
White (For White Frame FC12)	Z4	+ \$0	
Fog (For Fog Frame FC13)	Z7	+ \$0	

4. Arms

Arm Style	Code	Price	
Armless	A0	- \$48	
Fixed	A127	- \$10	
Height-Adjustable	A128	+ \$0	
Multi-Adjustable (Height/Width)	A129	+ \$30	

Arms, if specified, come with fog arm pads for the white and fog frames and black arm pads for the black frame.

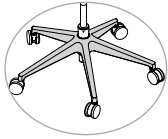
5. Base

Base Color and Material	Code	Price	
Black Nylon Base With Black Casters (For Black Frame FC1)	B0	+ \$0	
White Nylon Base With Fog/White Casters (For White Frame FC12)	B20	+ \$0	
Fog Nylon Base With Fog Casters (For Fog Frame FC13)	B21	+ \$0	
Brushed Aluminum Base	B8	+ \$113	
Heavy Duty Black Base, 26"	B7	+ \$0	

Heavy duty black base (B7) requires lower cylinder. Brushed aluminum base (B8) can be used with any frame color.

Brushed aluminum base (B8) with a standard synchro (F) mechanism requires a higher cylinder (S13).

THINTEX BACK TASK CHAIR

5. Base

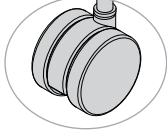
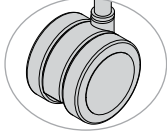
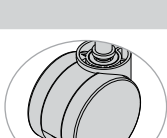
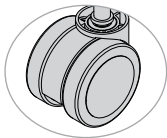
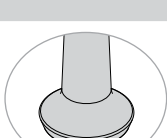
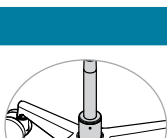
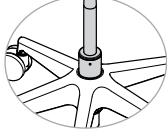
Casters or Glides	Code	Price	
Casters			
Black Carpet Casters (For Black Frame FC1)	C16	+ \$0	
Black Hard Floor and Carpet Casters (For Black Frame FC1)	C17	+ \$40	
Hard Floor and Carpet Casters (For Fog or White Frame FC12/FC13)	CS6	+ \$0	
Heavy Duty Casters			
Heavy Duty Carpet Casters	C11	+ \$0	
Heavy Duty Hard Floor and Carpet Casters	C9	+ \$61	
Glides			
Glides for Task Chairs	C3	+ \$30	
Cylinder Height			
Standard Cylinder	S0	+ \$0	
Higher Cylinder	S13	+ \$0	
Lower Cylinder	S10	+ \$0	
Lower cylinder (S10) is available for Heavy Duty (HD) model only.			
6. Material			
Protection	Code	Price	
CAL 133, Fabric, Quantities 1-49	133F	+ \$99	
CAL 133, Fabric, Quantities 50+	133F5	+ \$55	
CAL 133, Leather, Any Quantity	133L	+ \$119	

6. Material (Cont.)

Thintex Color	Code	Price	
Apple	MC31	+ \$0	
Aqua	MC30	+ \$0	
Desert	MC22	+ \$0	
Electric Blue	MC24	+ \$0	
Fire	MC25	+ \$0	
Fog	MC23	+ \$0	
Grape	MC26	+ \$0	
Lemon	MC27	+ \$0	
Nickel	MC21	+ \$0	
Ocean	MC29	+ \$0	
Onyx	MC20	+ \$0	
Tangerine	MC28	+ \$0	
Tangerine	MC28	+ \$0	
Seat Textile	Code	Price	
COM	COM	+ \$0	
Fabric/Vinyl Grade 1	FG1/VG1	+ \$0	
Fabric/Vinyl Grade 2	FG2/VG2	+ \$26	
Fabric/Vinyl Grade 3	FG3/VG3	+ \$60	
Fabric/Vinyl Grade 4	FG4/VG4	+ \$116	
Fabric/Vinyl Grade 5	FG5/VG5	+ \$172	
Fabric/Vinyl Grade 6	FG6/VG6	+ \$213	
Fabric/Vinyl Grade 7	FG7/VG7	+ \$254	
COL	COL	+ \$300	
Leather Grade 1	LG1	+ \$300	
Leather Grade 2	LG2	+ \$380	
Leather Grade 3	LG3	+ \$480	

Please reference the *Textile Reference Guide* for pricing on fabric over grade 7 and leather over grade 3.

7. Packaging

Packaging	Code	Price
Knocked Down	KD	+ \$0
Back Attached to Seat, Base Separate	UC	+ \$80
Fully Assembled in a Carton	AC	+ \$200

SPECIFICATIONS

	2222 B9 Midback Thintex Task Chair	2223 B9 Highback Thintex Task Chair
Overall Width	26"	26"
Overall Depth	26"	26"
Overall Height	36.75"	40.75"
Seat Width	20"	20"
Seat Depth	17.5"-19.5"	17.5"-19.5"
Seat Height	17.5"-21.25" (F/T) 16.63"-20.38" (B) 17.75"-21.5" (F/E3)	17.5"-21.25" (F/T) 16.63"-20.38" (B) 17.75"-21.5" (F/E3)
Seat Height With Higher Cylinder	19"-22.5" (F/T) 18"-21.5" (B) 19"-22.5" (F/E3)	19"-22.5" (F/T) 18"-21.5" (B) 19"-22.5" (F/E3)
Seat Height With Lower Cylinder (B7)	15.63"-18.68" (F) 15.5"-18.5" (T) 15"-18" (B) 16"-19" (F/E3)	15.63"-18.68" (F) 15.5"-18.5" (T) 15"-18" (B) 16"-19" (F/E3)
Back Width	18.75"	18.75"
Back Height	19"	23"
Weight Armless	30 lb	31 lb
Weight With Arms	36 lb	37 lb
COM	1 yd	1 yd
COL	17 sq ft	17 sq ft
Weight Capacity Warranty	300 lb	300 lb

Basic mechanism (B). Swivel-tilt mechanism (T). Standard synchro mechanism (F).
Seat-depth adjustment (E3).

Wit

THINTEX BACK TASK STOOL

Work smarter.

Gone are the days where you clock in, stay in your cubicle and clock out. Dynamic environments call for adaptable seating that rolls with the punches. Our Wit™ family does exactly that. Because this is a design inspired by truths about how people work.

Today's ever-changing marketplace calls for flexibility. Teams need to be able to set up shop anywhere—and at any time. All of our Wit task models are easily adjustable so anyone can find a seat, settle in and get right to work.



Featured Models

GOOD :: \$571

Midback task stool with adjustable lumbar, basic mechanism, armless, black frame, standard stool kit, black nylon base, carpet casters, grade 1 textile

BETTER :: \$619

Midback task stool with adjustable lumbar, basic mechanism, height-adjustable arms, black frame, standard stool kit, black nylon base, carpet casters, grade 1 textile

BEST :: \$688

Midback task stool with adjustable lumbar, basic mechanism, height-adjustable arms, white frame, extended stool kit, white nylon base, carpet casters, grade 1 textile

Features

- Midback task stool
- Standard adjustable lumbar support
- Built-in pull handle
- 12 Thintex back colors in fabric or vinyl
- Three frame colors
- Basic mechanism
- Multi-adjustable (height/width), height-adjustable, armless and fixed arms
- Textured designer arms
- Optional brushed aluminum base
- Waterfall seat
- Standard 300 lb weight capacity warranty
- Complemented by Wit Side; see page 260

1. Back

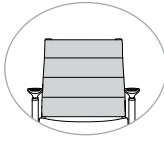
Back Size and Style	Code	Price	
Midback Thintex With Adjustable Lumbar Support	2222 B9	\$619	

Back Material	Code	Price	
Fabric	TX1	+ \$0	
Vinyl	TX2	+ \$0	

2. Mechanism

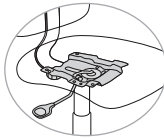

Mechanism	Code	Price	
Basic (Swivel Only)	B	+ \$0	

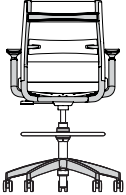
3. Frame

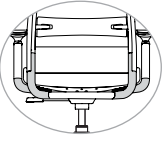
Frame Color	Code	Price	
Black	FC1	+ \$0	
White	FC12	+ \$45	
Fog	FC13	+ \$45	

Back Support Color	Code	Price	
Black (For Black Frame FC1)	Z1	+ \$0	
Silver (For Black Frame FC1)	Z2	+ \$0	
White (For White Frame FC12)	Z4	+ \$0	
Fog (For Fog Frame FC13)	Z7	+ \$0	

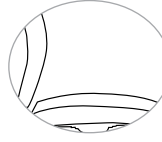
4. Arms

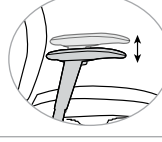
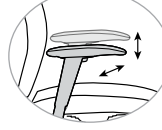
Arm Style	Code	Price	
Armless	A0	- \$48	
Fixed	A127	- \$10	
Height-Adjustable	A128	+ \$0	
Multi-Adjustable (Height/Width)	A129	+ \$30	

Arms, if specified, come with fog arm pads for the white and fog frames and black arm pads for the black frame.

5. Base

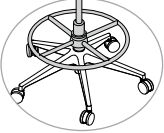
Base	Code	Price	
Stool Kit	S1	+ \$0	
Extended Stool Kit	S2	+ \$24	

Base Color and Material	Code	Price	
Black Nylon Base With Black Casters (For Black Frame FC1)	B0	+ \$0	
White Nylon Base With Fog/White Casters (For White Frame FC12)	B20	+ \$0	
Fog Nylon Base With Fog Casters (For Fog Frame FC13)	B21	+ \$0	

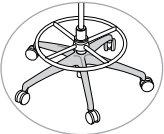
Brushed Aluminum Base	B8	+ \$113	
-----------------------	----	---------	---

Casters or Glides	Code	Price	
Casters			

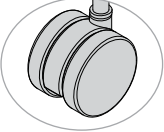
Black Carpet Casters (For Black Frame FC1)	C16	+ \$0	
---	-----	-------	---

Black Hard Floor and Carpet Casters (For Black Frame FC1)	C17	+ \$40	
--	-----	--------	---

Hard Floor and Carpet Casters (For Fog or White Frame FC12/FC13)	CS6	+ \$0
---	-----	-------

Glides			
---------------	--	--	--

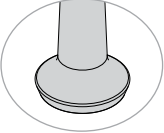
Glides for Task Chairs	C3	+ \$30	
------------------------	----	--------	---

Brushed aluminum base (B8) can be used with any frame color.

THINTEX BACK TASK STOOL

6. Material

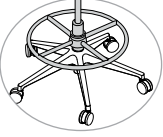
Protection	Code	Price	
CAL 133, Fabric, Quantities 1-49	133F	+ \$99	
CAL 133, Fabric, Quantities 50+	133F5	+ \$55	
CAL 133, Leather, Any Quantity	133L	+ \$119	

Thintex Color	Code	Price	
Apple	MC31	+ \$0	
Aqua	MC30	+ \$0	
Desert	MC22	+ \$0	
Electric Blue	MC24	+ \$0	
Fire	MC25	+ \$0	
Fog	MC23	+ \$0	
Grape	MC26	+ \$0	
Lemon	MC27	+ \$0	
Nickel	MC21	+ \$0	
Ocean	MC29	+ \$0	
Onyx	MC20	+ \$0	
Tangerine	MC28	+ \$0	

Seat Textile	Code	Price	
COM	COM	+ \$0	
Fabric/Vinyl Grade 1	FG1/VG1	+ \$0	
Fabric/Vinyl Grade 2	FG2/VG2	+ \$26	
Fabric/Vinyl Grade 3	FG3/VG3	+ \$60	
Fabric/Vinyl Grade 4	FG4/VG4	+ \$116	
Fabric/Vinyl Grade 5	FG5/VG5	+ \$172	
Fabric/Vinyl Grade 6	FG6/VG6	+ \$213	
Fabric/Vinyl Grade 7	FG7/VG7	+ \$254	
COL	COL	+ \$300	
Leather Grade 1	LG1	+ \$300	
Leather Grade 2	LG2	+ \$380	
Leather Grade 3	LG3	+ \$480	

Please reference the Textile Reference Guide for pricing on fabric over grade 7 and leather over grade 3.

7. Packaging

Packaging	Code	Price
Knocked Down	KD	+ \$0
Back Attached to Seat, Base Separate	UC	+ \$80
Fully Assembled in a Carton	AC	+ \$200

SPECIFICATIONS

	2222 B9 S1 Midback Thintex Task Stool	2222 B9 S2 Midback Thintex Extended Task Stool
Overall Width	27"	27"
Overall Depth	27"	27"
Overall Height	8.5" (B0/B20/B21) 36.5" (B8)	43" (B0/B20/B21) 41" (B8)
Seat Width	20"	20"
Seat Depth	17.5"	17.5"
Seat Height	22"-30"	26"-36"
Back Width	19"	19"
Back Height	18.75"	18.75"
Weight Armless	28.5 lb	29.5 lb
Weight With Arms	34.5 lb	35.5 lb
COM	1 yd	1 yd
COL	17 sq ft	17 sq ft
Weight Capacity Warranty	300 lb	300 lb

Black base (B0). White base (B20). Fog base (B21). Brushed aluminum base (B8).



Good

Chairs and Stools

MULTIPURPOSE | SIDE | GUEST | BARIATRIC
COUNTER STOOL | BAR STOOL

Statement of Line

MULTIPURPOSE | SIDE | GUEST | BARIATRIC
COUNTER STOOL | BAR STOOL

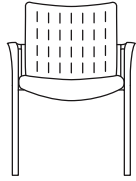

Achieve
4-Leg Multipurpose Chair
91 US 193

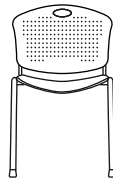

Anytime
4-Leg Multipurpose Chair
93 196

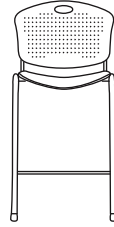

Anytime
4-Leg Bar Stool
93 S2 196



Baja
Wire Rod Multipurpose Chair
1171 FT2 BK4 199

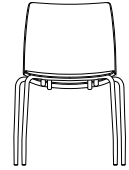

Baja
4-Leg Multipurpose Chair
1171 FT1 BK4 199

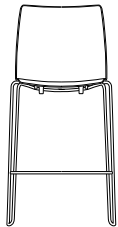

Baja
Wire Bar Stool
1171 FT2 S2 BK4 199

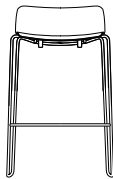

Baja
Low Back Wire Rod Bar
1171 FT2 S2 BK3 199

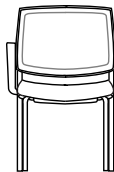

Focus
4-Leg Side Chair
5651/ 5652 203

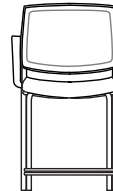

Focus Side
4-Leg Counter Stool
5651/5652 S9 203

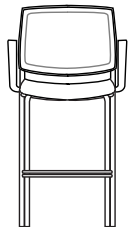

Focus Side
4-Leg Bar Stool
5651/5652 S2 203



Freelance
Wire Rod Multipurpose Chair
523X 208

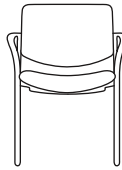

Freelance
4-Leg Multipurpose Chair
521X 208

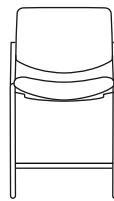

Freelance
4-Leg Counter Stool
5214 S9 208



Freelance
4-Leg Bar Stool
5214 S2 208



Freelance
30" Bariatric Chair
5314 213

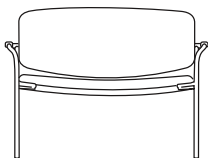

Freelance
42" Bariatric Chair
5414 213

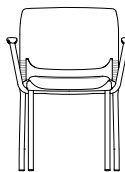

InFlex
4-Leg Multipurpose Chair
971 216

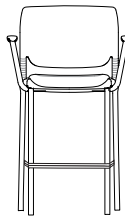

InFlex
4-Leg Multipurpose Chair
971 S9 216

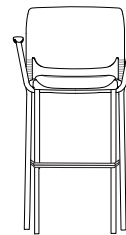

InFlex
4-Leg Multipurpose Chair
971 S2 216

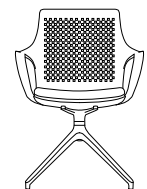

Ioniq
4-Star Guest Chair
1152 FT5 220

Statement of Line

MULTIPURPOSE | SIDE | GUEST | BARIATRIC
COUNTER STOOL | BAR STOOL

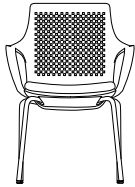

Ioniq
4-Leg Multipurpose Chair
1151 FT1..... 220

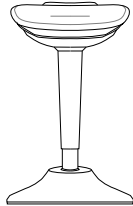

Kickstand
Stool
1167..... 224

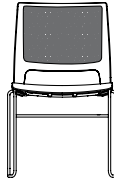

Lumin
Wire Rod Multipurpose Chair
1011 FT2..... 226

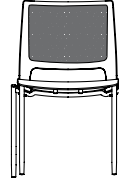

Lumin
4-Leg Multipurpose Chair
1011 FT1..... 226

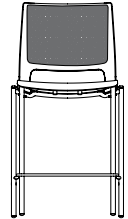

Lumin
4-Leg Counter Stool
1011 FT1 S9 226

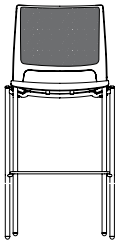

Lumin
4-Leg Bar Stool
1011 FT1 S2 226

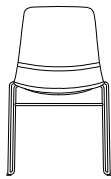

Mika
Wire Rod Multipurpose Chair
1011 FT1 S9 230



Mika
4-Leg Multipurpose Chair
1011 FT1 S9 230

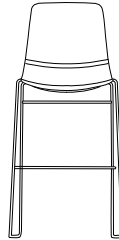

Mika
Wire Rod Bar Stool
1011 FT1 S9 230

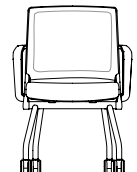

Movi
Nester Chair
1061 FT4..... 233

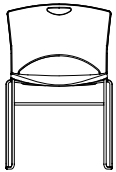

OnCall
Wire Rod Multipurpose Chair
90..... 236

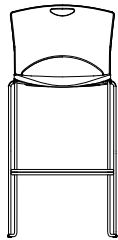

OnCall
Wire Rod Bar Stool
90 S2 236

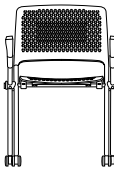

Qwiz
Nester Chair
1141 FT4..... 239

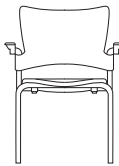

Relay
4-Leg Multipurpose Chair
94FB/94FS..... 243

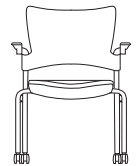

Relay
Nester Chair
94XB/94XS..... 243

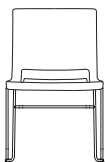

Rio
Wire Rod Multipurpose Chair
1051 FT2..... 249

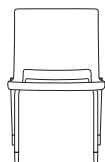

Rio
4-Leg Multipurpose Chair
1051 FT1..... 249



Rio
4-Leg Counter Stool
1051 FT1 S9 249



Rio
4-Leg Bar Stool
1051 FT1 S2 249

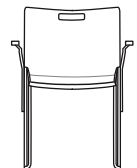

Rowdy
4-Leg Bar Stool
92 SB/92 SC..... 253

Statement of Line

MULTIPURPOSE | SIDE | GUEST | BARIATRIC
COUNTER STOOL | BAR STOOL

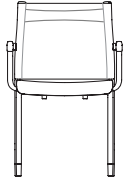

Wit Side Mesh

4-Leg Side Chair
222 FT1 MB 256

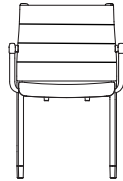

Wit Side Thintex

4-Leg Side Chair
2221 FT1 TXB 260

Achieve

MULTIPURPOSE CHAIR

Own the space.

Achieve upholstered and plastic side chairs provide the feel of a large chair but with a clean and slender profile. The concave back and contoured seat match the natural curves of the human body, combining comfortable ergonomic support with eye-catching contemporary design. The plastic model's perforated back allows the body to breathe, keeping the user cool while seated.



Featured Models

GOOD :: \$377

4-leg chair, plastic back and upholstered seat, armless, standard multi-surface glides, grade 1 textile

BETTER :: \$493

4-leg chair, upholstered seat and back, fixed loop arms, standard multi-surface glides, grade 1 textile

BEST :: \$533

4-leg chair, upholstered seat and back, fixed loop arms, hard floor and carpet casters, grade 1 textile

Features

- Clean and contemporary, ideal for guest and lobby areas, meeting and conference rooms
- Fully upholstered or plastic back with upholstered seat
- Generously proportioned contoured design follows the curves of the body
- Waterfall seat promotes proper leg circulation
- Wall-saver anti-tip frame design
- Additional seat foam option
- 250 lb weight capacity warranty

1. Back

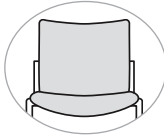
Back and Seat Style	Code	Price	
Black Plastic Back, Upholstered Seat	91 US	\$435	
Upholstered Seat and Back	91 UP	\$493	

2. Seat

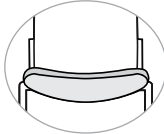
Seat Options	Code	Price	
1" Additional Foam	F1	+\$36	

3. Frame

Frame Finish and Style	Code	Price	
Black	FB	+\$0	
Silver	FS	+\$0	
Black With Black Carpet Casters	FCB	+\$40	
Silver With Black Carpet Casters	FCS	+\$40	

MULTIPURPOSE CHAIR

4. Base

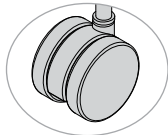
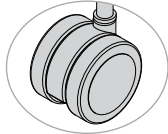
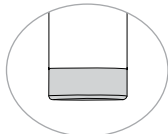
Casters or Glides	Code	Price	
Casters			
Carpet Casters	C13	+\$0	
Hard Floor and Carpet Casters	C12	+\$40	
Glides			
Standard Multi-Surface Glides	G6	+\$0	

Please use caution when stacking models with casters to prevent frame damage. SitOnIt Seating does not warrant scratched frames.

5. Arms

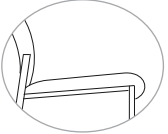
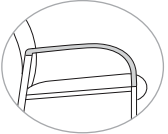
Arm Style	Code	Price	
Armless	A0	-\$58	
Fixed Loop	A40	+\$0	

6. Miscellaneous

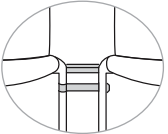
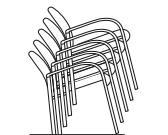
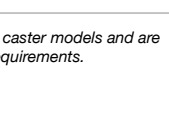
Accessories	Code	Price	
Ganging Bracket for Armless Models	GG4	+\$28	
Ganging Bracket for Models With Arms	GA4	+\$28	
Stacking Cart	14-Cart	+\$324	

Ganging brackets and stacking carts are not intended for use with caster models and are compatible with glides only. See page 37 for additional stacking requirements.

7. Material

Protection	Code	Price
CAL 133, Fabric, Quantities 1-49	133F	+ \$99
CAL 133, Fabric, Quantities 50+	133F5	+ \$55
CAL 133, Leather, Any Quantity	133L	+ \$119

Textile	Code	Price
Seat Textile (For US)		
COM	COM	+ \$0
Fabric/Vinyl Grade 1	FG1/VG1	+ \$0
Fabric/Vinyl Grade 2	FG2/VG2	+ \$22
Fabric/Vinyl Grade 3	FG3/VG3	+ \$45
Fabric/Vinyl Grade 4	FG4/VG4	+ \$77
Fabric/Vinyl Grade 5	FG5/VG5	+ \$116
Fabric/Vinyl Grade 6	FG6/VG6	+ \$159
Fabric/Vinyl Grade 7	FG7/VG7	+ \$200
COL	COL	+ \$140
Leather Grade 1	LG1	+ \$140
Leather Grade 2	LG2	+ \$200
Leather Grade 3	LG3	+ \$280

Seat and Back (For UP)		
COM	COM	+ \$0
Fabric/Vinyl Grade 1	FG1/VG1	+ \$0
Fabric/Vinyl Grade 2	FG2/VG2	+ \$34
Fabric/Vinyl Grade 3	FG3/VG3	+ \$74
Fabric/Vinyl Grade 4	FG4/VG4	+ \$121
Fabric/Vinyl Grade 5	FG5/VG5	+ \$174
Fabric/Vinyl Grade 6	FG6/VG6	+ \$235
Fabric/Vinyl Grade 7	FG7/VG7	+ \$296
COL	COL	+ \$260
Leather Grade 1	LG1	+ \$260
Leather Grade 2	LG2	+ \$320
Leather Grade 3	LG3	+ \$400

Please reference the *Textile Reference Guide* for pricing on fabric over grade 7 and leather over grade 3.

8. Packaging

Packaging	Code	Price
Fully Assembled in Carton	AC3	+ \$0
Individually Packaged	AC1	+ \$20

MULTIPURPOSE CHAIR

SPECIFICATIONS

Model:	91 Multipurpose Chair
Overall Width Armless	22"
Overall Width With Arms	25"
Overall Depth	24"
Overall Height	33.5"
Seat Width	19.5"
Seat Depth	19"
Seat Height	18"
Back Width	18"
Back Height	16"
Weight Armless	18 lb
Weight With Arms	21 lb
COM	1 yd (US) 1.75 yd (UP)
COL	17 sq ft (US) 30 sq ft (UP)
Cart Stacking	5
Floor Stacking	4
Weight Capacity Warranty	250 lb

Upholstered seat only (US). Upholstered seat and back (UP).



Better

Anytime

MULTIPURPOSE CHAIR AND BAR STOOL

Grab and go. Anywhere.

The economical Anytime collection was designed for corporate, government and educational settings where flexibility and style are key requirements. The perforated plastic back (available in 9 designer colors) provides ample ventilation and upholstered pads can be added for increased comfort. You can also specify Anytime as fully upholstered or with an upholstered seat only. Frame colors are either black or silver. The pull handle ensures that the Anytime side chair is ready to go anytime and anywhere it is needed.



Good

Featured Models

GOOD :: \$245

All plastic, armless, standard multi-surface glides

BETTER :: \$303

Upholstered seat, plastic back, armless, standard multi-surface glides

BEST :: \$419

Upholstered seat and back, fixed arms, standard multi-surface glides

Features

- Fully upholstered, upholstered seat or plastic
- Nine plastic colors
- Perforated shell provides ventilation
- Built-in pull handle
- Black or silver tubular frame
- Stacks six on the floor; eight on the optional cart
- 250 lb weight capacity warranty
- Complements Anytime light task chair and stool; see page 59

1. Back

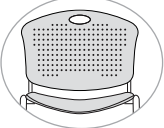
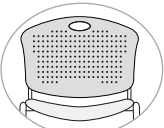
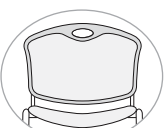
Back and Seat Style	Code	Price	
Plastic	No Code	\$245	
Upholstered Seat Only	US	\$303	
Upholstered Seat and Back	UP	\$361	

2. Frame

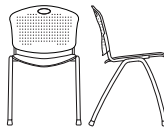
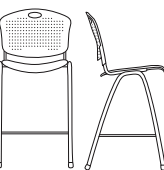
Frame Type	Code	Price	
4-Leg	93	+ \$0	
30" Bar Stool	93 S2	+ \$150	



Bar stools (S2) are available with glides only.

MULTIPURPOSE CHAIR AND BAR STOOL

2. Frame (Cont.)

Frame Finish	Code	Price	
Black	FB	+ \$0	
Black With Casters	FCB	+ \$40	
Silver	FS	+ \$0	
Silver With Casters	FCS	+ \$40	

3. Arms

Arm Style	Code	Price	
Armless	A0	+ \$0	
Fixed Loop Arms (Black)	A48	+ \$58	
Fixed Loop Arms (Silver)	A49	+ \$58	

4. Base

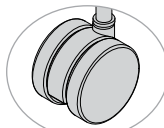
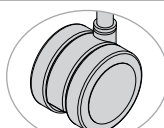
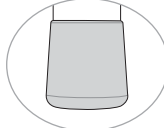
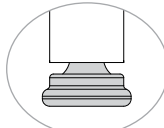
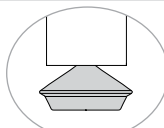
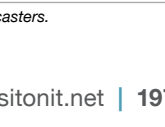
Casters or Glides	Code	Price	
Casters			
Carpet Casters	C13	+ \$0	
Hard Floor and Carpet Casters	C12	+ \$40	
Glides			
Standard Multi-Surface Glide	G7	+ \$0	
Floor Saver Glides	G15	+ \$17	
Steel Glides (Carpet Only)	G14	+ \$17	
Performance Multi-Surface Glides	GL2	+ \$17	

Casters not available with bar stool (S2). Do not stack chairs with casters.

5. Miscellaneous

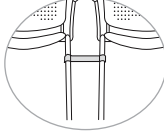
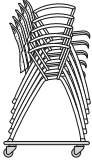
Accessories	Code	Price	
Ganging Bracket for Armless Models	GG6	+ \$30	
Ganging Bracket for Models With Arms	GA6	+ \$30	
Stacking Cart	93-Cart	+ \$324	

Ganging brackets and stacking carts are not available for caster models and are only available for chairs with glides. See page 37 for additional stacking requirements.

Due to the nature of upholstery, stacking may cause impressions on the seat. SitOnIt Seating does not warrant the effects of stacking on upholstery.

See page 37 for additional stacking requirements.

6. Material

Protection	Code	Price	
CAL 133, Fabric, Quantities 1–49	133F	+ \$99	
CAL 133, Fabric, Quantities 50+	133F5	+ \$55	
CAL 133, Plastic, Any Quantity	133P	+ \$45	
Shell Color	Code	Price	
Arctic	SC21	+ \$0	
Black	SC1	+ \$0	
Chocolate	SC4	+ \$0	
Lagoon	SC15	+ \$0	
Latte	SC20	+ \$0	
Navy	SC5	+ \$0	
Red	SC19	+ \$0	
Slate	SC8	+ \$0	
Sterling	SC18	+ \$0	
Textile	Code	Price	
Seat Only (For US)			
COM	COM	+ \$0	
Fabric/Vinyl Grade 1	FG1/VG1	+ \$0	
Fabric/Vinyl Grade 2	FG2/VG2	+ \$22	
Fabric/Vinyl Grade 3	FG3/VG3	+ \$45	
Fabric/Vinyl Grade 4	FG4/VG4	+ \$77	
Fabric/Vinyl Grade 5	FG5/VG5	+ \$116	
Fabric/Vinyl Grade 6	FG6/VG6	+ \$159	
Fabric/Vinyl Grade 7	FG7/VG7	+ \$200	

MULTIPURPOSE CHAIR AND BAR STOOL

6. Material (Cont.)

Textile (Cont.)	Code	Price	
Seat and Back (For UP)			
COM	COM	+ \$0	
Fabric/Vinyl Grade 1	FG1/VG1	+ \$0	
Fabric/Vinyl Grade 2	FG2/VG2	+ \$34	
Fabric/Vinyl Grade 3	FG3/VG3	+ \$74	
Fabric/Vinyl Grade 4	FG4/VG4	+ \$121	
Fabric/Vinyl Grade 5	FG5/VG5	+ \$174	
Fabric/Vinyl Grade 6	FG6/VG6	+ \$235	
Fabric/Vinyl Grade 7	FG7/VG7	+ \$296	

Please reference the Textile Reference Guide for pricing on fabric over grade 7.

7. Packaging

Packaging	Code	Price	
Fully Assembled in Carton	AC	+ \$0	
Individually Packaged	AC1	+ \$20	

SPECIFICATIONS

Model:	93 4-Leg Multipurpose	93 S2 30" Bar Stool
Overall Width Armless	21.5"	22"
Overall Width With Arms	26.5"	27"
Overall Depth	22"	22"
Overall Height	32.5"	44"
Seat Width	19"	19"
Seat Depth	18"	18"
Seat Height	18"	30.5"
Back Width	21.5"	21.5"
Back Height	14.5"	14.5"
Weight Armless	14 lb	21.5 lb
Weight With Arms	18 lb	25.5 lb
COM	0.8 yd (US) 1 yd (UP)	0.8 yd (US) 1 yd (UP)
Cart Stacking	8	N/A
Floor Stacking	6	N/A
Weight Capacity Warranty	250 lb	250 lb

Upholstered seat (US). Upholstered seat and back (UP).

Baja

MULTIPURPOSE CHAIR AND BAR STOOL

Immerse in possibilities.

Let's come together. When you want to feel the room and fill the room, there's Baja. Its comfort, customization, features and function will stand out—all while blending in – and echo the vibe of any space with subtle sophistication. Discover what's possible when you're surrounded by cohesive design.



Good

Featured Models

GOOD :: \$320

All plastic, 4-leg, armless, standard multi-surface glides

BETTER :: \$378

Plastic back and upholstered seat, 4-leg, armless, standard multi-surface glides, grade 1 textile



BEST :: \$494

Fully upholstered, 4-leg, fixed arms, standard multi-surface glides, grade 1 textile

Features

- Scale and sculpture offer a roomier, more comfortable sit
- Seamless design and broad collection create cohesion in any space
- Residential-inspired features and options, including standard and low-back stools
- Responsive, single-piece shell offers 18 degrees of backrest flex
- Bases include wire rod, wire rod stool and 4-leg with casters or glides
- Choose from 14 shell colors, three arm pad colors, two wire rod and three 4-leg finishes
- Stackable on the floor or on a cart for quick clean-up and easy storage
- 300 lb weight capacity warranty



1. Frame

Frame Type	Code	Price	
4-Leg	1171 FT1	\$320	
Wire Rod	1171 FT2	\$297	
30" Wire Rod Bar Stool	1171 FT2 S2	\$447	



Frame Finish	Code	Price	
4-Leg (FT1) Only			
Black	FC1	+ \$0	
Silver	FC2	+ \$0	
White	FC12	+ \$0	
Wire Rod (FT2) Only			
Black	FC1	+ \$0	
Chrome	FC15	+ \$0	

MULTIPURPOSE CHAIR AND BAR STOOL

2. Back and Seat

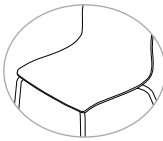
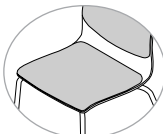
Back Size	Code	Price	
Standard Back	BK4	+ \$0	
Low Back	BK3	+ \$0	

Seat Style	Code	Price	
Plastic Seat	PS	+ \$0	
Upholstered Seat	US	+ \$58	



Back Style	Code	Price	
Plastic Back	PB	+ \$0	
Upholstered Back	UB	+ \$58	

Low back option available for bar stool (S2) only.

Upholstered back (UB) option available only with upholstered seat (US) and is not compatible with the low back (BK3) option.

Due to the nature of upholstery, stacking may cause impressions on the seat. SitOnIt Seating does not warrant the effects of stacking on upholstery.

3. Arms

Arm Style	Code	Price	
Armless	AR0	+ \$0	
Fixed Arms	AR1	+ \$58	

Fixed arms available on 4-leg chair (FT1) only. Arm finish matches frame finish. Arm pads are black on the black (FC1) frame or fog on the silver (FC2) and white on the white (FC12) frames.

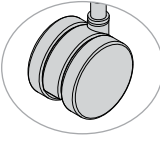
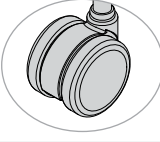
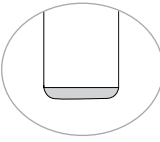
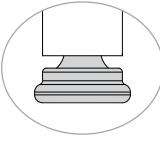
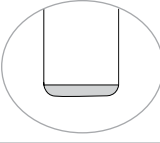
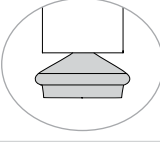
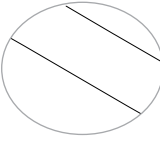
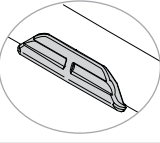
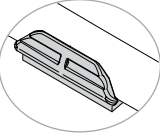

4. Base

Casters or Glides	Code	Price	
Casters (For 4-Leg Chair FT1 Only)			
Carpet Casters	CS5	+ \$40	
Hard Floor and Carpet Casters	CS6	+ \$80	
Glides (For 4-Leg Chair FT1 Only)			
Standard Multi-Surface Glides	GL1	+ \$0	
Performance Multi-Surface Glides	GL2	+ \$17	
Floor Saver Glides	GL3	+ \$17	
Steel Glides (Carpet Only)	GL4	+ \$17	
Glides (For Wire Rod FT2 Only)			
No Glides	G0	+ \$0	
Clear Glides	CGR	+ \$9	
Clear Glides With Felt	CGRF	+ \$22	

Casters are black on the black (FC1) frame or fog on the silver (FC2) and white on the white (FC12) frames.

MULTIPURPOSE CHAIR AND BAR STOOL

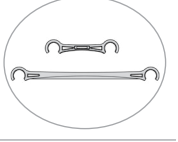
5. Miscellaneous

Accessories	Code	Price	
Ganging Bracket	GG	+ \$30	
Stacking Cart	CART	+ \$399	

Ganging Brackets (GG) available on armless (AR0) models only.

Please use caution when stacking models with casters to prevent frame damage. SitOnIt Seating does not warrant scratched frames.

See page 37 for additional stacking requirements.

6. Material

Shell Color	Code	Price	
Black	SC1	+ \$0	
Chocolate	SC4	+ \$0	
Latte	SC20	+ \$0	
Navy	SC5	+ \$0	
Slate	SC8	+ \$0	
Apple	SC24	+ \$0	
Arctic	SC21	+ \$0	
Bisque	SC7	+ \$0	
Lagoon	SC15	+ \$0	
Lemon	SC25	+ \$0	
Pacific	SC22	+ \$0	
Red	SC19	+ \$0	
Sterling	SC18	+ \$0	
Tangerine	SC23	+ \$0	
Textile	Code	Price	Textile
Seat Only (US)			
COM	COM	+ \$0	
Fabric/Vinyl Grade 1	FG1/VG1	+ \$0	
Fabric/Vinyl Grade 2	FG2/VG2	+ \$22	
Fabric/Vinyl Grade 3	FG3/VG3	+ \$45	
Fabric/Vinyl Grade 4	FG4/VG4	+ \$77	
Fabric/Vinyl Grade 5	FG5/VG5	+ \$116	
Fabric/Vinyl Grade 6	FG6/VG6	+ \$159	
Fabric/Vinyl Grade 7	FG7/VG7	+ \$200	

6. Material (Cont.)

Textile (Cont.)	Code	Price
Seat and Back (US + UB)		
COM	COM	+ \$0
Fabric/Vinyl Grade 1	FG1/VG1	+ \$0
Fabric/Vinyl Grade 2	FG2/VG2	+ \$34
Fabric/Vinyl Grade 3	FG3/VG3	+ \$74
Fabric/Vinyl Grade 4	FG4/VG4	+ \$121
Fabric/Vinyl Grade 5	FG5/VG5	+ \$174
Fabric/Vinyl Grade 6	FG6/VG6	+ \$235
Fabric/Vinyl Grade 7	FG7/VG7	+ \$296

Please reference the Textile Reference Guide for pricing on fabric over grade 7.

7. Packaging

Packaging	Code	Price
Fully Assembled in Carton, Individually Packaged	AC1	+ \$20
Fully Assembled in Carton	AC	+ \$0

CHAIR SPECIFICATIONS

	1171 FT1 4-Leg Chair	1171 FT2 Wire Rod Chair
Overall Width With Arms	27"	N/A
Overall Width Armless	22.25"	22"
Overall Depth	21.5"	22.5"
Overall Height	32.5"	32"
Seat Width	18.5"	18.5"
Seat Depth	18"	18"
Seat Height	18"	17.5"
Back Width	18.25"	18.25"
Back Height	15.75"	16.5"
Weight With Arms	18 lb	N/A
Weight Armless	16 lb	15 lb
COM	0.75 yd (US) 1 yd (UB)	0.75 yd (US) 1 yd (UB)
Cart Stacking Armless	10 (PS) 8 (US/UB)	6 (PS) 4 (US/UB)
Cart Stacking With Arms	10 (PS) 8 (US/UB)	N/A
Floor Stacking Armless	6 (PS) 4 (US/UB)	6
Floor Stacking With Arms	6 (PS) 4 (US/UB)	N/A
Weight Capacity Warranty	300 lb	300 lb

Plastic seat (PS). Upholstered seat (US). Upholstered back (UB).

MULTIPURPOSE CHAIR AND BAR STOOL

STOOL SPECIFICATIONS

Model:	1171 FT2 S2 30" Wire Rod Bar Stool
Overall Width Armless	22"
Overall Depth	22.5"
Overall Height	45" (BK4) 35.25" (BK3)
Seat Width	18.5"
Seat Depth	18"
Seat Height	29.5"
Back Width	18.25"
Back Height	16.5" (BK4) 7" (BK3)
Weight Armless	22 lb (BK4) 20 lb (BK3)
COM	0.75 yd (US) 1 yd (UB)
Floor Stacking Armless	4
Weight Capacity	300 lb

Upholstered seat (US). Upholstered back (UB). Standard back (BK4). Low back (BK3).



Best

Focus Side

MULTIPURPOSE CHAIR, COUNTER AND BAR STOOL

Where comfort, style and ergonomics converge.

The revitalized Focus™ Side combines comfort and design for multi-purpose, office or reception areas. Choose either the 4-leg side chair, bar or counter stools in 3 back options – mesh, upholstered and wood. Two different frame finishes permit it to blend in—or stand out. Focus Side is part of a broad and versatile collection that includes executive and task models. Designed to complement Focus and Amplify task chairs.



Featured Models

GOOD :: \$358

4-leg chair, upholstered seat, mesh back, standard multi-surface glides, armless, grade 1 textile

BETTER :: \$410

4-leg chair, upholstered seat, mesh back, standard multi-surface glides, arms, grade 1 textile

BEST :: \$575

4-leg chair, upholstered seat, clear maple slotted wood back, arms, carpet casters, grade 1 textile

FOCUS SIDE

GSA SIN #: 33721

Features

- 4-leg side chair, 30" bar and 24" counter stool models
- Three back options: mesh, wood and fully upholstered
- 15 bleach-cleanable mesh back colors
- Two wood back styles and 4 wood stain finishes
- Black or silver frame
- Upholstered waterfall seat
- Mesh back model stacks four on the floor, five on the optional cart; upholstered back model stacks three on the floor, three on the optional cart
- 300 lb weight capacity warranty
- Complements Focus and Focus 2.0 task chairs and stools; see page 62 and page 80



MULTIPURPOSE CHAIR, COUNTER STOOL AND BAR STOOL

1. Frame

Model and Frame Finish	Code	Price	
Chairs			
Black	5651	\$410	
Silver	5652	\$410	
Black With Black Carpet Casters	5641	\$450	
Silver With Black Carpet Casters	5642	\$450	
Stools			
24" Black Counter Stool	5651 S9	\$560	
24" Silver Counter Stool	5652 S9	\$560	
30" Black Bar Stool	5651 S2	\$560	
30" Silver Bar Stool	5652 S2	\$560	





2. Back

Back Style	Code	Price	
Mesh	B1	+ \$0	
Upholstered	B3	+ \$0	
Solid Wood	WB1	+ \$125	
Slotted Wood	WB2	+ \$125	

FOCUS SIDE

GSA SIN #: 33721

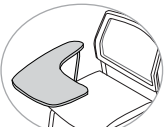
3. Arms

Arm Style	Code	Price	
Armless	A0	- \$58	
Fixed Loop	A130	+ \$0	
Tablet Arm	Code	Price	
3-Week Lead Time			
Tablet Arm, Left	TLS	+ \$98	
Tablet Arm, Right	TRS	+ \$98	
Oversized Tablet Arm	TSO	+ \$130	

Tablet arms are not available with stools or casters. Not stackable.

4. Base

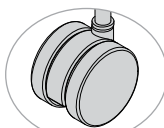
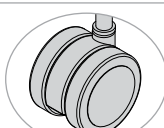
Casters and Glides	Code	Price	
Casters			
Carpet Casters	C13	+ \$0	
Hard Floor and Carpet Casters	C12	+ \$40	



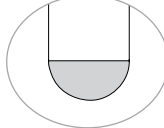
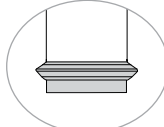
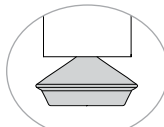
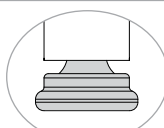

MULTIPURPOSE CHAIR, COUNTER STOOL AND BAR STOOL

4. Base (Cont.)

Casters and Glides	Code	Price	
Glides			
Standard Multi-Surface Glides	G5	+ \$0	
Floor Saver Glides	G12	+ \$17	
Performance Multi-Surface Glides	GL2	+ \$17	
Steel Glides (Carpet Only)	G13	+ \$17	

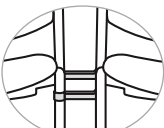
Please use caution when stacking models with casters to prevent frame damage. SitOnIt Seating does not warrant scratched frames. Casters are not available on counter stool (S9) or bar stool (S2).

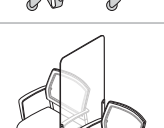
5. Miscellaneous

Accessories	Code	Price	
Ganging Bracket for Armless Models	GG11	+ \$30	
Ganging Bracket for Models With Arms	GA11	+ \$30	
Stacking Cart	56-Cart	+ \$324	
Sector Seating Screen	3097 52X	+ \$460	

Ganging brackets and stacking carts are not intended for use with caster models or stools and are compatible with glides only. Wood back chairs (WB1/WB2) are not stackable. See page 3 for additional stacking requirements.

See Sector Seating Screens on page 466 for more specification details.

6. Material

Protection	Code	Price
CAL 133, Fabric, Quantities 1-49	133F	+ \$99
CAL 133, Fabric, Quantities 50+	133F5	+ \$55
CAL 133, Leather, Any Quantity	133L	+ \$119
Mesh Color (For B1)	Code	Price
Matches Amplify		
Apple	MC31	+ \$0
Aqua	MC30	+ \$0
Desert	MC9	+ \$0
Electric Blue	MC24	+ \$0
Fire	MC10	+ \$0
Fog	MC7	+ \$0
Navy	MC8	+ \$0
Nickel	MC6	+ \$0
Onyx	MC5	+ \$0
Tangerine	MC28	+ \$0
Matches Focus		
Black	MC1	+ \$0
Sand	MC3	+ \$0
Slate	MC2	+ \$0
Freeway Sport Stripe (Black/Slate)	MC33	+ \$0
Impress Sport Stripe (Slate/Black)	MC34	+ \$0
Wood Stain (For WB)	Code	Price
Amber Mahogany	S5	+ \$0
Clear Maple	S1	+ \$0
Espresso	S8	+ \$0
Medium Cherry	S3	+ \$0
Stain-to-Match	SM	+ \$55

Stain-to-Match (SM): If stain is not in our library, add a one-time \$350 fee. There is a 15-day lead time for stain-to-match.

MULTIPURPOSE CHAIR, COUNTER STOOL AND BAR STOOL

6. Material (Cont.)

Textile	Code	Price
Seat Only (For B1/WB)		
COM	COM	+ \$0
Fabric/Vinyl Grade 1	FG1/VG1	+ \$0
Fabric/Vinyl Grade 2	FG2/VG2	+ \$22
Fabric/Vinyl Grade 3	FG3/VG3	+ \$45
Fabric/Vinyl Grade 4	FG4/VG4	+ \$77
Fabric/Vinyl Grade 5	FG5/VG5	+ \$116
Fabric/Vinyl Grade 6	FG6/VG6	+ \$159
Fabric/Vinyl Grade 7	FG7/VG7	+ \$200
COL	COL	+ \$140
Leather Grade 1	LG1	+ \$140
Leather Grade 2	LG2	+ \$200
Leather Grade 3	LG3	+ \$280
Seat and Back (For B3)		
COM	COM	+ \$0
Fabric/Vinyl Grade 1	FG1/VG1	+ \$0
Fabric/Vinyl Grade 2	FG2/VG2	+ \$34
Fabric/Vinyl Grade 3	FG3/VG3	+ \$74
Fabric/Vinyl Grade 4	FG4/VG4	+ \$121
Fabric/Vinyl Grade 5	FG5/VG5	+ \$174
Fabric/Vinyl Grade 6	FG6/VG6	+ \$235
Fabric/Vinyl Grade 7	FG7/VG7	+ \$296
COL	COL	+ \$260
Leather Grade 1	LG1	+ \$260
Leather Grade 2	LG2	+ \$320
Leather Grade 3	LG3	+ \$400

Please reference the Textile Reference Guide for pricing on fabric over grade 7 or leather over grade 3.

7. Packaging

Packaging	Code	Price
Fully Assembled in Carton (Chairs)	AC3	+ \$0
Chairs: Individually Packed	AC1	+ \$20
Stools: Individually Packed	AC1	+ \$0

FOCUS SIDE

GSA SIN #: 33721

CHAIR SPECIFICATIONS

Model:	5651 / 5652 Side Chair	5641 / 5642 Side Chair with Casters
Overall Width Armless	20.5"	20.5"
Overall Width With Arms	24.5"	24.5"
Overall Depth	26" (B1/WB) 25" (B3)	26" (B1/WB) 25" (B3)
Overall Height	34" (B1) 32.5" (B3/WB)	34" (B1) 32.5" (B3/WB)
Seat Width	18"	18"
Seat Depth	18.5"	18.5"
Seat Height	18"	18"
Back Width	20.5"	20.5"
Back Height	18"	18"
Weight Armless	21 lb (B1/B3) 22 lb (WB)	21 lb (B1/B3) 22 lb (WB)
Weight With Arms	24 lb (B1/B3) 25 lb (WB)	24 lb (B1/B3) 25 lb (WB)
COM	1 yd (B1/WB) 1.25 yd (B3)	1 yd (B1/WB) 1.25 yd (B3)
COL	12 sq ft (B1/WB) 20 sq ft (B3)	12 sq ft (B1/WB) 20 sq ft (B3)
Maximum Cart Stacking	5 (B1 Only) 3 (B3 Only)	5 (B1 Only) 3 (B3 Only)
Maximum Floor Stacking	4 (B1 Only) 3 (B3 Only)	4 (B1 Only) 3 (B3 Only)
Cart Stacking Weight Armless	133.5 lb	Not Recommended
Cart Stacking Weight With Arms	148.5 lb	Not Recommended
Floor Stacking Weight Armless	84 lb	Not Recommended
Floor Stacking Weight With Arms	96 lb	Not Recommended
Weight Capacity Warranty	300 lb	300 lb

Mesh back (B1). Upholstered back (B3). Wood back (WB).

MULTIPURPOSE CHAIR, COUNTER STOOL AND BAR STOOL

STOOL SPECIFICATIONS

	5651 S9 / 5652 S9 24" Counter Stool	5652 S1 / 5652 S2 30" Bar Stool
Overall Width Armless	20.5"	20.5"
Overall Width With Arms	24.5"	24.5"
Overall Depth	26" (B1/WB) 25" (B3)	26" (B1/WB) 25" (B3)
Overall Height	39.5" (B1) 37" (B3/WB)	46.5" (B1) 44" (B3/WB)
Seat Width	18"	18"
Seat Depth	18.5"	18.5"
Seat Height	24"	31"
Back Width	20.5"	20.5"
Back Height	18"	18"
Weight Armless	28 lb (B1/B3) 29 lb (WB)	30 lb (B1/B3) 31 lb (WB)
Weight With Arms	31 lb (B1) 32 lb (B3/WB)	33 lb (B1) 34 lb (B3/WB)
COM	1 yd (B1/WB) 1.25 yd (B3)	1 yd (B1/WB) 1.25 yd (B3)
COL	17 sq ft (B1/WB) 20 sq ft (B3)	17 sq ft (B1/WB) 20 sq ft (B3)
Weight Capacity Warranty	300 lb	300 lb

Mesh back (B1). Upholstered back (B3). Wood back (WB).



Best

Freelance

MULTIPURPOSE CHAIR, COUNTER STOOL AND BAR STOOL

Built for durability.

Imagine the versatility.

The transitional design of Freelance side chairs works well in lobby areas, workstations and offices. The comfortable, curved seat and structural integrity has made it a high-demand, multipurpose chair. Three frame/arm finish combinations create variety. Add casters or book rack for ultimate mobility and flexibility in training rooms and collaborative spaces. Freelance is a broad collection of 4-leg, sled, counter and bar stools.



Featured Models

GOOD :: \$349

4-leg chair, all plastic seat and back, arms, standard multi-surface glides

BETTER :: \$407

4-leg upholstered seat and back, arms, standard multi-surface glides, grade 1 textile



BEST :: \$447

4-leg upholstered seat and back, arms, carpet casters, grade 1 textile

Features

- Fully upholstered, upholstered seat or plastic
- Nine plastic colors
- Three frame/arm finish combinations: black, bisque and silver/slate. (Bisque not available on stool models.)
- Waterfall seat
- Molded shroud underside
- Wall-saver frame design
- Optional book rack
- Stacks four on floor, six on the optional cart (chairs with sled bases do not stack)
- 250 lb weight capacity warranty for plastic chairs; 300 lb weight capacity warranty for upholstered chairs; 350 lb Heavy Duty 24/7 weight capacity warranty

1. Back

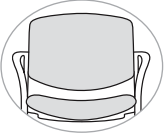
Back and Seat Style	Code	Price	
Plastic	No Code	\$345	
Upholstered Seat	US	\$382	
Upholstered Seat and Back	UP	\$407	

2. Heavy Duty

Heavy Duty Series	Code	Price	
Heavy Duty	HD	+ \$306	



Heavy Duty option only available on upholstered 4-leg chair frame (521) with glides. See page 38 for additional LT and HD options.

MULTIPURPOSE CHAIR, COUNTER STOOL AND BAR STOOL

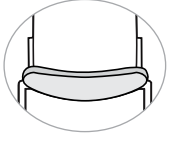
3. Seat

Seat Options	Code	Price	
1" Additional Foam	F1	+ \$36	

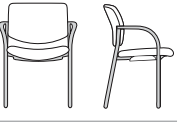
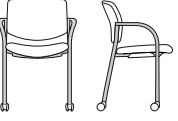
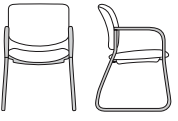
4. Frame

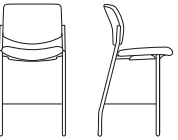
Frame Type	Code	Price	
Chairs			
4-Leg Chair	521X	+ \$0	
4-Leg Chair With Carpet Casters	522X	+ \$40	
Sled Base Chair	523X	+ \$126	
Stools			
24" Counter Stool	5214 S9	\$150	
30" Bar Stool	5214 S2	\$150	

Frame Finish	Code	Price	
2-Day Lead Time			
Black	FB	+ \$0	
Silver	FS	+ \$0	
3-Week Lead Time			
Bisque	FC7	+ \$0	





Arm color will match the frame color unless otherwise specified. Sled base is not stackable. "x" = arm or armless; see arms section on the following page.

Bisque frame finish is not available on stools.

FREELANCE

GSA SIN #: 33721

5. Arms

Arm Style	Code	Price	
For Chairs			
Armless (Append Arm Code to Frame Type Code)	XXX3	- \$58	
Fixed Loop Arms (Append Arm Code to Frame Type Code)	XXX4	+ \$0	
For Stools			
Armless	5213	- \$58	
Fixed Loop Arms	5214	+ \$0	

Arm Color	Code	Price	
2-Day Lead Time			
Black	AC3	+ \$0	
Slate	AC4	+ \$0	
3-Week Lead Time			
Bisque	AC5	+ \$0	

Arm color will match the frame color unless specified otherwise. Bisque (AC5) arm is not available on stool models (S2/S9).

6. Base

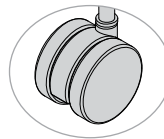
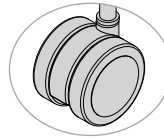
Casters or Glides	Code	Price	
Casters			
Carpet Casters	C13	+ \$0	
Hard Floor and Carpet Casters	C12	+ \$40	
Glides for Sled Base (523x)			
No Glides	N	+ \$0	
Glides	G3	+ \$30	

Casters are not available on stool models.

MULTIPURPOSE CHAIR, COUNTER STOOL AND BAR STOOL

6. Base (Cont.)

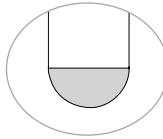
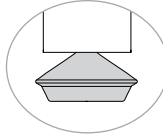
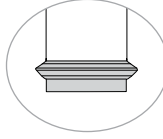
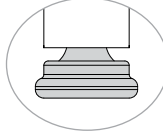
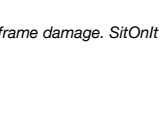
Arm Color	Code	Price	
Glides for 4-Leg Chair (521X/522X) and Stool (S2/S9)			
Standard Multi-Surface Glides	G5	+ \$0	
Performance Multi-Surface Glides	GL2	+ \$17	
Performance Multi-Surface Glides for Heavy Duty Option Only	GL2	+ \$0	
Floor Saver Glides	G12	+ \$17	
Steel Glides (Carpet Only)	G13	+ \$17	

Glides (GL2) are standard for Heavy Duty (HD) option.



Please use caution when stacking models with casters to prevent frame damage. SitOnIt Seating does not warrant scratched frames.



FREELANCE

GSA SIN #: 33721

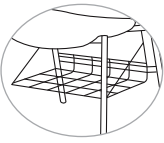
7. Miscellaneous

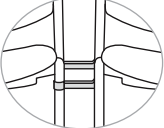
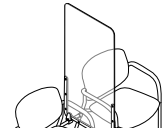
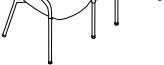
Accessories	Code	Price	
Book Rack (Black)	BRF	+ \$79	
Stacking Cart	14-Cart	+ \$324	
Ganging Bracket for Armless Models	GG2	+ \$30	
Ganging Bracket for Models With Arms	GA2	+ \$30	
Sector Seating Screen	3097 56X	+ \$460	

Accessories are not compatible with stool models (S2/(S9).

Book rack for 4-leg frame only. Book rack (BRF) and stacking cart (14-cart) are not for use with caster models (522x). See page 37 for additional stacking requirements.

Please use caution when stacking models with casters to prevent frame damage. SitOnIt Seating does not warrant scratched frames.

See Sector Seating Screens on page 466 for additional specification details.

8. Material

Protection	Code	Price	
CAL 133, Fabric, Quantities 1–49	133F	+ \$99	
CAL 133, Fabric, Quantities 50+	133F5	+ \$55	
CAL 133, Plastic, Any Quantity	133P	+ \$45	
Ballistic Nylon Back	Code	Price	
Ballistic Nylon Back	BN	+ \$0	
Shell Color	Code	Price	
Arctic	SC21	+ \$0	
Black	SC1	+ \$0	
Chocolate	SC4	+ \$0	
Lagoon	SC15	+ \$0	
Latte	SC20	+ \$0	
Navy	SC5	+ \$0	
Red	SC19	+ \$0	
Slate	SC8	+ \$0	
Sterling	SC18	+ \$0	

MULTIPURPOSE CHAIR, COUNTER STOOL AND BAR STOOL

8. Material (Cont.)

Textile	Code	Price	
Seat Only (For US)			
COM	COM	+ \$0	
Fabric/Vinyl Grade 1	FG1/VG1	+ \$0	
Fabric/Vinyl Grade 2	FG2/VG2	+ \$22	
Fabric/Vinyl Grade 3	FG3/VG3	+ \$45	
Fabric/Vinyl Grade 4	FG4/VG4	+ \$77	
Fabric/Vinyl Grade 5	FG5/VG5	+ \$116	
Fabric/Vinyl Grade 6	FG6/VG6	+ \$159	
Fabric/Vinyl Grade 7	FG7/VG7	+ \$200	
Seat and Back (UP)			
COM	COM	+ \$0	
Fabric/Vinyl Grade 1	FG1/VG1	+ \$0	
Fabric/Vinyl Grade 2	FG2/VG2	+ \$34	
Fabric/Vinyl Grade 3	FG3/VG3	+ \$74	
Fabric/Vinyl Grade 4	FG4/VG4	+ \$121	
Fabric/Vinyl Grade 5	FG5/VG5	+ \$174	
Fabric/Vinyl Grade 6	FG6/VG6	+ \$235	
Fabric/Vinyl Grade 7	FG7/VG7	+ \$296	
COL	COL	+ \$140	
Leather/Ballistic Grade 1	LG1	+ \$140	
Leather/Ballistic Grade 2	BN2	+ \$249	
Leather/Ballistic Grade 3	BN3	+ \$321	

Please reference the Textile Reference Guide for pricing on fabric over grade 7 and leather over grade 3.

9. Packaging

Packaging	Code	Price	
Sled Chair: Fully Assembled in a Carton	AC1	+ \$0	
Stools: Fully Assembled in a Carton	AC	+ \$0	
4-Leg Models			
Fully Assembled in Carton, When 3 Are Ordered	3C	+ \$0	
Fully Assembled in Carton, When 2 Are Ordered	2C	+ \$10	
Individually Packaged	AC1	+ \$20	

FREELANCE

GSA SIN #: 33721

CHAIR SPECIFICATIONS

Model:	5213 / 5214 5223 / 5224 4-Leg Multipurpose Chair	5233 / 5234 Sled Base Multipurpose Chair
Overall Width Armless	21.5"	21.5"
Overall Width With Arms	25"	25"
Overall Depth	24"	25"
Overall Height	33.25"	33.25"
Seat Width	19.5"	19.5"
Seat Depth	18.5"	18.5"
Seat Height	17.5"	17.5"
Back Width	19.5"	19.5"
Back Height	16"	16"
Weight Armless	26.5 lb	27.5 lb
Weight With Arms	28.5 lb	29.5 lb
Weight Armless (3 Pack)	80 lb	N/A
Weight With Arms (3 Pack)	86 lb	N/A
COM	.99 yd (US) .99 yd (US) (BN) 1.25 yd (UP) 1.15 yd (UP) (BN)	.99 yd (US) .99 yd (US) (BN) 1.25 yd (UP) 1.15 yd (UP) (BN)
COL	15 sq ft (US) 15 sq ft (US) (BN) 25 sq ft (UP) 21 sq ft (UP) (BN)	15 sq ft (US) 15 sq ft (US) (BN) 25 sq ft (UP) 21 sq ft (UP) (BN)
Weight Capacity Warranty	250 lb (Plastic/US) 300 lb (UP) 350 lb (HD)	250 lb (Plastic/US) 300 lb (UP) (N/A)

Upholstered seat only (US). Upholstered seat and back (UP). Ballistic nylon (BN). Heavy Duty (HD).

MULTIPURPOSE CHAIR, COUNTER STOOL AND BAR STOOL

STOOL SPECIFICATIONS

Model:	5213 S9 / 5214 S9 24" Counter Stool	5213 S2 / 5214 S2 30" Bar Stool
Overall Width Armless	21.5"	21.5"
Overall Width With Arms	25"	25"
Overall Depth	24"	24"
Overall Height	39"	45"
Seat Width	19.5"	19.5"
Seat Depth	18.5"	18.5"
Seat Height	24"	30"
Back Width	19.5"	19.5"
Back Height	16"	16"
Weight Armless	24 lb	26 lb
Weight With Arms	26 lb	28 lb
COM	0.99 yd (US) 0.99 yd (US) (BN) 1.25 yd (UP) 1.15 yd (UP) (BN)	0.99 yd (US) 0.99 yd (US) (BN) 1.25 yd (UP) 1.15 yd (UP) (BN)
COL	15 sq ft (US) 15 sq ft (US) (BN) 25 sq ft (UP) 21 sq ft (UP) (BN)	15 sq ft (US) 15 sq ft (US) (BN) 25 sq ft (UP) 21 sq ft (UP) (BN)
Weight Capacity Warranty	250 lb (Plastic) 300 lb (US/UP)	250 lb (Plastic) 300 lb (US/UP)

Upholstered seat only (US). Upholstered seat and back (UP). Ballistic nylon back (BN).



Best

Freelance

BARIATRIC CHAIR

Built for durability. Imagine the versatility.

The transitional design of Freelance bariatric side chairs works well in lobby areas and offices. The comfortable, curved seat and structural integrity has made it a high-demand, multipurpose chair. Three frame/arm finish combinations create variety. The Freelance collection is ideal for heavy-duty and bariatric applications.



30" Bariatric

Featured Models

30" BARIATRIC :: \$807

30" bariatric side, performance multi-surface glides, grade 1 textile

42" BARIATRIC :: \$1,224

42" bariatric side, performance multi-surface glides, grade 1 textile

Features

- Three frame/arm finish combinations: black, bisque and silver/sate
- Waterfall seat
- Molded shroud underside
- Wall-saver frame design
- Stacks 4 on floor, 6 on the optional cart (chairs with sled bases do not stack)
- 500 lb weight capacity warranty on 30" model; 1,000 lb capacity on 42" model

1. Seat

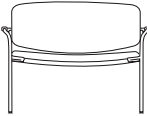
Seat Size	Code	Price	
30" Seat With Arms	5314	\$807	
42" Seat With Arms	5414	\$1,224	

2. Frame

Frame Finish	Code	Price	
2-Day Lead Time			
Black	FB	+ \$0	
Silver	FS	+ \$0	
3-Week Lead Time			
Bisque	FC7	+ \$0	

Arm color will match the frame color unless otherwise specified.

3. Base

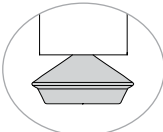
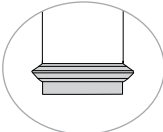
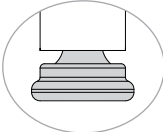
Glides	Code	Price	
Performance Multi-Surface Glides	GL2	+ \$0	
Floor Saver Glides	G12	+ \$17	
Steel Glides (Carpet Only)	G13	+ \$17	



42" Bariatric

FREELANCE

GSA SIN #: 33721

4. Arms

Arm Color	Code	Price
Bisque	AC5	+ \$0
Black	AC3	+ \$0
Slate	AC4	+ \$0



Arm color will match the frame color unless otherwise specified.

5. Material

Protection	Code	Price
CAL 133, Fabric, Quantities 1-49	133F	+ \$99
CAL 133, Fabric, Quantities 50+	133F5	+ \$55
CAL 133, Leather, Any Quantity	133L	+ \$119
Ballistic Nylon Back	Code	Price
Ballistic Nylon Back	BN	+ \$0
Seat and Back Textile	Code	Price
COM	COM	+ \$0
Fabric/Vinyl Grade 1	FG1/VG1	+ \$0
Fabric/Vinyl Grade 2	FG2/VG2	+ \$40
Fabric/Vinyl Grade 3	FG3/VG3	+ \$84
Fabric/Vinyl Grade 4	FG4/VG4	+ \$156
Fabric/Vinyl Grade 5	FG5/VG5	+ \$228
Fabric/Vinyl Grade 6	FG6/VG6	+ \$304
Fabric/Vinyl Grade 7	FG7/VG7	+ \$378
COL	COL	+ \$240
Leather Grade 1	LG1	+ \$240
Leather Grade 2	LG2	+ \$540
Leather Grade 3	LG3	+ \$820
Leather/Ballistic Grade 2	BN2	+ \$379
Leather/Ballistic Grade 3	BN3	+ \$631

Please reference the *Textile Reference Guide* for pricing on fabric over grade 7 and leather over grade 3.

BARIATRIC CHAIR

6. Packaging

Packaging	Code	Price
Fully Assembled in a Carton	AC	+ \$0

SPECIFICATIONS

Model:	5314 30" Bariatric Chair	5414 42" Bariatric Chair
Overall Width With Arms	36.5"	48.5"
Overall Depth	25.5"	25.5"
Overall Height	32.5"	35"
Seat Width	30"	42"
Seat Depth	19"	18"
Seat Height	19"	19"
Back Width	30"	42"
Back Height	16"	16"
Weight With Arms	42.5 lb	62.5 lb
COM	2.25 yd 1.67 yd (BN)	2.5 yd 1.75 yd (BN)
COL	40 sq ft 30 sq ft (BN)	42 sq ft 40 sq ft (BN)
Weight Capacity Warranty	500 lb	1,000 lb

Ballistic nylon (BN).

InFlex

MULTIPURPOSE CHAIR, COUNTER STOOL AND BAR STOOL

Geometry in motion.

Designed by Giancarlo Piretti, this multipurpose, stacking chair offers contemporary styling and spine-friendly comfort—at an affordable price.

Versatile InFlex comes in both plastic stacking side models and upholstered side, task and stool versions. The contemporary styling of this Piretti chair emulates the human spine. Its innovative flex-back disc system, with 13 degrees of back angle range, is as clever as it is comfortable.



Good

Featured Models

GOOD :: \$264

4-leg chair, all plastic seat and back, armless, standard multi-surface glides

BETTER :: \$322

4-leg chair, plastic back, upholstered seat, armless, standard multi-surface glides, grade 1 textile



BEST :: \$438

4-leg chair, upholstered seat and back, fixed cantilever arms, standard multi-surface glides, grade 1 textile

Features

- Giancarlo Piretti design
- Innovative disc system emulates the human spine
- Plastic model stack five on the floor, 12 on the optional cart
- Upholstered armless model stack five on the floor; 10 on the optional cart
- Fully upholstered, upholstered seat or plastic
- 14 plastic colors
- Two frame finishes
- 300 lb weight capacity warranty
- Complements InFlex light task chair and stool; see page 91

1. Back

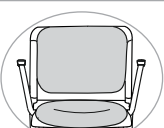
Seat and Back Style	Code	Price	
Plastic Seat and Back	No Code	\$264	
Upholstered Seat Only	US	\$322	
Upholstered Seat and Back	UP	\$380	

Do not stack upholstered chairs with arms.

MULTIPURPOSE CHAIR, COUNTER STOOL AND BAR STOOL



2. Frame

Frame Type	Code	Price	
4-Leg	971	+ \$0	
4-Leg With Black Carpet Casters	974	+ \$40	
24" Counter Stool	971 S9	+ \$150	
30" Bar Stool	971 S2	+ \$150	

Frame Finish	Code	Price	
Black	FC1	+ \$0	
Silver	FC2	+ \$0	



Counter (S9) and bar (S2) stools are available with glides only.

Arms

Arm Style	Code	Price	
Armless	A0	+ \$0	
Fixed Cantilever	A121	+ \$58	

MULTIPURPOSE CHAIR, COUNTER STOOL AND BAR STOOL

3. Arms (Cont.)

Tablet Arms	Code	Price	
3-Week Lead Time			
Tablet Arm, Left	TLI	+ \$156	
Tablet Arm, Right	TRI	+ \$156	
Oversized Tablet Arm, Right	TIO	+ \$188	

Tablet Laminate Color	Code	Price	
Black	1	+ \$0	
Grey Nebula	5	+ \$0	

Tablet Edge Color	Code	Price	
Black	TE1	+ \$0	

Tablet arms are not available with stools or casters. Not stackable. Tablet arms are not available with stools or casters. Not stackable.

4. Base

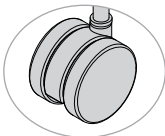
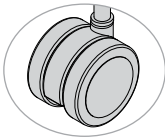
Casters or Glides	Code	Price	
Casters			
Carpet Casters	C13	+ \$0	
Hard Floor and Carpet Casters	C12	+ \$40	

4. Base (Cont.)

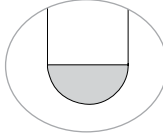
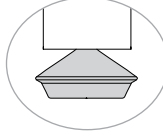
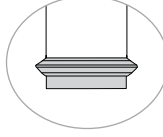
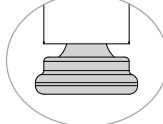
Casters or Glides (Cont.)	Code	Price	
Glides			
Standard Multi-Surface Glides	G11	+ \$0	
Performance Multi-Surface Glides	GL2	+ \$17	
Floor Saver Glides	G12	+ \$17	
Steel Glides (Carpet Only)	G13	+ \$17	

Please use caution when stacking models with casters to prevent frame damage. SitOnIt Seating does not warrant scratched frames.

5. Miscellaneous

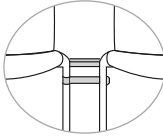
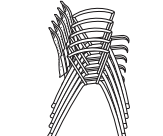
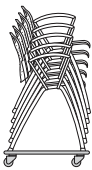
Accessories	Code	Price	
Ganging Bracket for Armless Models	GG9	+ \$30	
Ganging Bracket for Models With Arms	GA9	+ \$30	
Stacking Cart	97-Cart	+ \$399	

Ganging brackets and stacking carts are not intended for use with caster models and are compatible with glides only.

Due to the nature of upholstery, stacking may cause impressions on the seat. SitOnIt Seating does not warrant the effects of stacking on upholstery.

See page 37 for additional stacking requirements.

6. Material

Protection	Code	Price	
CAL 133, Fabric, Quantities 1-49	133F	+ \$99	
CAL 133, Fabric, Quantities 50+	133F5	+ \$55	
CAL 133, Plastic, Any Quantity	133P	+ \$45	
Shell Color (For Plastic and US)	Code	Price	
Apple	SC24	+ \$0	
Arctic	SC21	+ \$0	
Bisque	SC7	+ \$0	
Black	SC1	+ \$0	
Chocolate	SC4	+ \$0	
Lagoon	SC15	+ \$0	
Latte	SC20	+ \$0	
Lemon	SC25	+ \$0	
Navy	SC5	+ \$0	
Pacific	SC22	+ \$0	
Red	SC19	+ \$0	
Slate	SC8	+ \$0	
Sterling	SC18	+ \$0	
Tangerine	SC23	+ \$0	
Textile	Code	Price	
Seat Only (For US)			
COM	COM	+ \$0	
Fabric/Vinyl Grade 1	FG1/VG1	+ \$0	
Fabric/Vinyl Grade 2	FG2/VG2	+ \$22	
Fabric/Vinyl Grade 3	FG3/VG3	+ \$45	
Fabric/Vinyl Grade 4	FG4/VG4	+ \$77	
Fabric/Vinyl Grade 5	FG5/VG5	+ \$116	
Fabric/Vinyl Grade 6	FG6/VG6	+ \$159	
Fabric/Vinyl Grade 7	FG7/VG7	+ \$200	
Seat and Back (For UP)			
COM	COM	+ \$0	
Fabric/Vinyl Grade 1	FG1/VG1	+ \$0	
Fabric/Vinyl Grade 2	FG2/VG2	+ \$34	
Fabric/Vinyl Grade 3	FG3/VG3	+ \$74	
Fabric/Vinyl Grade 4	FG4/VG4	+ \$121	
Fabric/Vinyl Grade 5	FG5/VG5	+ \$174	
Fabric/Vinyl Grade 6	FG6/VG6	+ \$235	
Fabric/Vinyl Grade 7	FG7/VG7	+ \$296	

Please reference the *Textile Reference Guide* for pricing on fabric over grade 7.

MULTIPURPOSE CHAIR, COUNTER STOOL AND BAR STOOL

7. Packaging

Packaging	Code	Price	
Fully Assembled in a Carton	AC4	+ \$0	
Individually Packaged Stools	AC1	+ \$20	
Individually Packaged Chairs	AC1	+ \$20	

SPECIFICATIONS

Model:	971 / 974 Multipurpose Chair	971 S9 24" Counter Stool	971 S2 30" Bar Stool
Overall Width Armless	20"	19.75"	19.75"
Overall Width With Arms	24.125"	25"	25"
Overall Depth	22"	22.25"	22.25"
Overall Height	33"	38.5"	43.5"
Seat Width	17"	16.75"	16.75"
Seat Depth	17"	18.5"	18.5"
Seat Height	18"	24"	29"
Back Width	20"	19.75"	19.75"
Back Height	15.5"	15.5"	15.5"
Weight Armless	18 lb	22 lb	23 lb
Weight With Arms	22 lb	26 lb	27 lb
COM	0.85 yd (US) 1 yd (UP)	0.85 yd (US) 1 yd (UP)	0.85 yd (US) 1 yd (UP)
Weight Capacity Warranty	300 lb	300 lb	300 lb

Upholstered seat only (US). Upholstered seat and back (UP).

Ioniq

GUEST CHAIR

Inspire unique.

There's a specialness that flows through Ioniq. Its form and feeling are fluid—from the way the arms stretch seamlessly out of a sculpted shell to base options that are as varied and versatile as the spaces they occupy. Because when you desire aesthetics that elevate any experience and offer something refreshingly different, there's only one go-to. And that's Ioniq.



Ioniq Guest

Featured Model

GUEST :: \$703

Plastic back, upholstered seat, integrated arms, 360-degree swivel, 4-star polished aluminum base. standard multi-surface glides, grade 1 textile

Features

- Breathable back with built-in lumbar support
- Minimalist-designed mechanism with streamlined controls
- Edge-to-edge cushion
- Fully integrated armrests
- Single-piece sculpted shell
- 4-star aluminum base
- 300 lb weight capacity warranty
- Complements Ioniq collaborative; see page 95

1. Frame

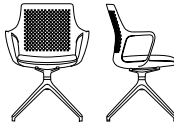
Frame Type	Code	Price	
Guest (4-Star Base)	1152 FT5	\$703	

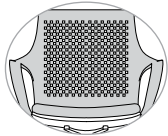
Seat and Back Style	Code	Price	
Plastic Back With Upholstered Seat Pad	US PB	+ \$0	

Shell Color	Code	Price	
Black	SC1	+ \$0	
White	SC26	+ \$0	

2. Base

Base Type and Material	Code	Price	
4-Star Polished Aluminum	BT5	+ \$0	

Glides	Code	Price	
Standard Multi-Surface Glides	GL1	+ \$0	

3. Mechanism

Mechanism	Code	Price	
Swivel 360-Degree	FHB	+ \$0	

GUEST CHAIR

4. Material

Seat Textile	Code	Price
COM	COM	+ \$0
Fabric/Vinyl Grade 1	FG1/VG1	+ \$0
Fabric/Vinyl Grade 2	FG2/VG2	+ \$22
Fabric/Vinyl Grade 3	FG3/VG3	+ \$45
Fabric/Vinyl Grade 4	FG4/VG4	+ \$77
Fabric/Vinyl Grade 5	FG5/VG5	+ \$116
Fabric/Vinyl Grade 6	FG6/VG6	+ \$159
Fabric/Vinyl Grade 7	FG7/VG7	+ \$200
COL	COL	+ \$140
Leather Grade 1	LG1	+ \$140
Leather Grade 2	LG2	+ \$200
Leather Grade 3	LG3	+ \$280

Please reference the *Textile Reference Guide* for pricing on fabric over grade 7 and leather over grade 3.

5. Packaging

Packaging	Code	Price
Back Attached to Seat, Base Separate	UC	+ \$0
Fully Assembled in a Carton	AC	+ \$120

SPECIFICATIONS

	1152 FT5 Guest Chair
Overall Width	28.25"
Overall Depth	28.24"
Overall Height	34.5"
Seat Width	20"
Seat Depth	17.38"
Seat Height	18.25"
Back Width	18"
Back Height	17.38"
Weight	18.5 lb
COM	0.75 yd
COL	7 sq ft
Weight Capacity Warranty	300 lb

Chair is widest at the base.

Ioniq

MULTIPURPOSE CHAIR

Inspire unique.

There's a specialness that flows through Ioniq. Its form and feeling are fluid—from the way the arms stretch seamlessly out of a sculpted shell to base options that are as varied and versatile as the spaces they occupy. Because when you desire aesthetics that elevate any experience and offer something refreshingly different, there's only one go-to. And that's Ioniq.



Ioniq Side

Featured Model

SIDE :: \$488

4-leg, chrome finish, plastic back with upholstered seat pad, integrated arms, standard multi-surface glides, grade 1 textile

Features

- Breathable back with built-in lumbar support
- Edge-to-edge cushion
- Fully integrated armrests
- Single-piece sculpted shell
- 4-leg base
- 300 lb weight capacity warranty
- Complements Ioniq collaborative; see page 95

1. Frame

Frame Type	Code	Price	
4-Leg	1151 FT1	\$488	

Frame Finish	Code	Price	
Chrome	FC15	+\$0	

Do not stack Ioniq side chairs. Frames are not stackable.

2. Seat and Back

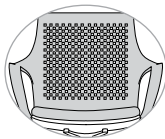
Seat and Back Style	Code	Price	
Plastic Back With Upholstered Seat Pad	US PB	+\$0	

3. Base

Glides	Code	Price	
Standard Multi-Surface Glides	GL1	+\$0	

SIDE CHAIR

4. Material

Shell Color	Code	Price	
Black	SC1	+\$0	
White	SC26	+\$0	
Seat Textile	Code	Price	
COM	COM	+\$0	
Fabric/Vinyl Grade 1	FG1/VG1	+\$0	
Fabric/Vinyl Grade 2	FG2/VG2	+\$22	
Fabric/Vinyl Grade 3	FG3/VG3	+\$45	
Fabric/Vinyl Grade 4	FG4/VG4	+\$77	
Fabric/Vinyl Grade 5	FG5/VG5	+\$116	
Fabric/Vinyl Grade 6	FG6/VG6	+\$159	
Fabric/Vinyl Grade 7	FG7/VG7	+\$200	
COL	COL	+\$140	
Leather Grade 1	LG1	+\$140	
Leather Grade 2	LG2	+\$200	
Leather Grade 3	LG3	+\$280	

Please reference the *Textile Reference Guide* for pricing on fabric over grade 7.

5. Packaging

Packaging	Code	Price	
Fully Assembled in Carton	AC	+\$0	

One per carton only.

SPECIFICATIONS

Model:	1151 FT1 4-Leg Multipurpose Chair
Overall Width	23"
Overall Depth	21.38"
Overall Height	32.5"
Seat Width	20"
Seat Depth	17.38"
Seat Height	17.63"
Back Width	18"
Back Height	17.38"
Weight	15.5 lb
COM	0.75 yd
COL	7 sq ft
Weight Capacity Warranty	300 lb

Kickstand

STOOL

Lean into work.

Introducing a whole new way to work. There's sitting. There's standing. And now there's perching with Kickstand™. It's an active alternative that provides limitless opportunities for body-benefitting postures, giving you the support you need to lean forward and focus on what's in front of you.



Black

Featured Models

BLACK :: \$469

Black finish, upholstered seat and grade 1 fabric

FOG :: \$488

Fog finish, upholstered seat and grade 1 fabric

Features

- Ergo-sculpted, bolstered seat alleviates pressure points while offering soft, flexible edges
- Customize the cushion with access to thousands of fabrics
- Lightweight frame with easy-grip handle means your new posture is always within reach
- Included auto-return cylinder ensures the seat always faces forward
- Streamlined ambidextrous controls make it easy to adjust from either side for various worksurface heights
- Stable, non-slip base with responsive 360-degree pivoting support keeps you energized and productive
- 250 lb weight capacity warranty

1. Frame

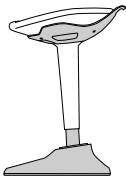
Frame Type	Code	Price	
Sit-to-Stand Stool	1167	\$469	

Frame Finish	Code	Price	
Black	FC1	+ \$0	
Fog	FC13	+ \$19	

Frame finish applies to base, column cover and outer seat.

2. Seat

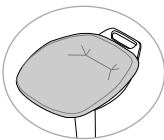
Seat Style	Code	Price	
Upholstered Seat	US	+ \$0	

STOOL

3. Base

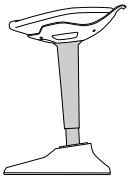
Stool Kit	Code	Price	
Extended Stool Kit	S2	+ \$0	

4. Material

Seat Textile	Code	Price	
COM	COM	+ \$0	
Fabric Grade 1	FG1	+ \$0	
Fabric Grade 2	FG2	+ \$22	
Fabric Grade 3	FG3	+ \$45	
Fabric Grade 4	FG4	+ \$77	
Fabric Grade 5	FG5	+ \$116	
Fabric Grade 6	FG6	+ \$159	
Fabric Grade 7	FG7	+ \$200	

Please reference the [Textile Reference Guide](#) for pricing on fabric over grade 7.

To minimize the risk of injury from sliding off Kickstand's forward-tilting seat, SitOnIt Seating does not offer vinyl or leather upholstery options.

5. Packaging

Packaging	Code	Price	
Knocked Down - Individually Packaged	KD	+ \$0	

SPECIFICATIONS

Model:	1167 Stool
Overall Width	15.5"
Overall Depth	18.125"
Overall Height	25.75"-35.875"
Seat Width	15.25"
Seat Depth	15.25"
Seat Height	23.5"-33.75"
Weight	17.5 lb
COM	0.75 yd
Weight Capacity Warranty	250 lb

Lumin

MULTIPURPOSE CHAIR, COUNTER STOOL AND BAR STOOL

Light up the room.

Lumin is an elegant multipurpose stackable chair designed for exceptional support and comfort in corporate and education applications. The contoured seat dissipates pressure points for greater comfort while the perforated back adds contemporary style and comfortable breathability. The Lumin multipurpose stackable chair, counter and bar stools are available in black, silver or chrome frame finish with matching arm pad colors. Refined, sophisticated Lumin will light up the room.



Featured Models

GOOD :: \$270

4-leg chair, plastic seat and back, armless, standard multi-surface glides

BETTER :: \$328

4-leg chair, plastic back, upholstered seat, armless, standard multi-surface glides, grade 1 textile

BEST :: \$444

4-leg chair, upholstered seat and back, fixed arms, standard multi-surface glides, grade 1 textile

MULTIPURPOSE CHAIR, COUNTER STOOL AND BAR STOOL

Features

- Contemporary design
- 4-leg and wire rod chair, counter and bar stools
- Exceptional support and comfort
- Fully upholstered, upholstered seat or plastic
- 14 plastic shell colors
- Three frame finishes with matching arm pads
- Left or right folding tablet arm in two finishes
- Built-in pull handle
- Clean-out space
- 4-leg plastic model stacks six on the floor; eight on the optional cart
- Wire frame plastic model stacks eight on the floor; 15 on the optional cart
- 300 lb weight capacity warranty
- Complements Lumin light task chair and stool; see page 105

1. Frame

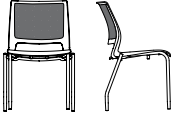
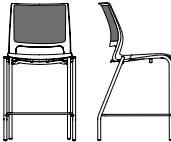
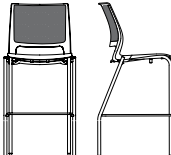
Frame Type	Code	Price	
Wire Rod	1011 FT2	\$247	
4-Leg	1011 FT1	\$270	
24" Counter Stool	1011 FT1 S9	\$420	
30" Bar Stool	1011 FT1 S2	\$420	



Counter (S9) and bar (S2) stools are only available with glides.

1. Frame (Cont.)

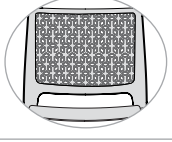

Frame Finish	Code	Price
Black	FC1	+ \$0
Silver (For 4-Leg Frame)	FC2	+ \$0
Chrome (For Wire Rod Frame)	FC15	+ \$0

Arms and glides, if specified, are black for black frames and fog for silver or chrome frames.

2. Back

Back and Seat Style	Code	Price	
Plastic Seat	PS	+ \$0	
Upholstered Seat Only	US	+ \$58	
Upholstered Seat and Back	UP	+ \$116	

3. Arms

Arm Style	Code	Price	
Armless	A0	+ \$0	
Fixed (For 4-Leg Frame)	A147	+ \$58	
Fixed (For Wire Rod Frame)	A146	+ \$58	
Tablet Arm	Code	Price	
Folding Tablet Arm, Left	RMTL	+ \$156	
Folding Tablet Arm, Right	RMTR	+ \$156	

Tablet arms are not available with stools (S9/S2). Tablet arms are not stackable.

4. Base

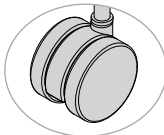
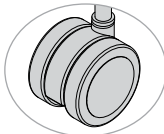
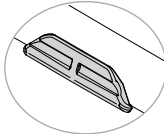
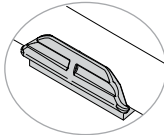
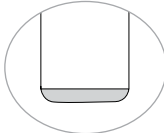

Casters or Glides	Code	Price	
Casters			
Carpet Casters	C13	+ \$40	
Hard Floor and Carpet Casters	C12	+ \$80	
Glides for Wire Rod Frames			
No Glides	G0	+ \$0	
Clear Glides	CGR	+ \$9	
Clear Glides With Felt	CGRF	+ \$22	
Glides for 4-Leg Frames			
Standard Multi-Surface Glides	GL1	+ \$0	
Floor Saver Glides	GL3	+ \$17	
Steel Glides (Carpet Only)	GL4	+ \$17	
Performance Multi-Surface Glides	GL2	+ \$17	

Counter (S9) and bar (S2) stools are only available with glides.

Please use caution when stacking models with casters to prevent frame damage. SitOnIt Seating does not warrant scratched frames.

MULTIPURPOSE CHAIR, COUNTER STOOL AND BAR STOOL

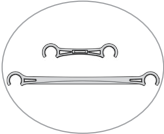
5. Miscellaneous

Accessories	Code	Price	
Ganging Bracket for 4-Leg Armless Models	GG10	+ \$30	
Ganging Bracket for 4-Leg Models With Arms	GA10	+ \$30	
Ganging Bracket for Wire Rod Armless Models	GG3	+ \$30	
Ganging Bracket for Wire Rod Models With Arms	GA3	+ \$30	
Stacking Cart	1011-CART	+ \$399	

Ganging brackets and stacking carts are not intended for use with caster models and are compatible with glides only. See page 37 for additional stacking requirements.

6. Material

Protection	Code	Price	
CAL 133, Fabric, Quantities 1-49	133F	+ \$64	
CAL 133, Fabric, Quantities 50+	133F5	+ \$20	
CAL 133, Plastic, Any Quantity	133P	+ \$10	



Best

6. Material (Cont.)

Shell Color	Code	Price	
Apple	SC24	+ \$0	
Arctic	SC21	+ \$0	
Bisque	SC7	+ \$0	
Black	SC1	+ \$0	
Chocolate	SC4	+ \$0	
Lagoon	SC15	+ \$0	
Latte	SC20	+ \$0	
Lemon	SC25	+ \$0	
Navy	SC5	+ \$0	
Pacific	SC22	+ \$0	
Red	SC19	+ \$0	
Slate	SC8	+ \$0	
Sterling	SC18	+ \$0	
Tangerine	SC23	+ \$0	
Textile	Code	Price	
Seat Only (For US)			
COM	COM	+ \$0	
Fabric/Vinyl Grade 1	FG1/VG1	+ \$0	
Fabric/Vinyl Grade 2	FG2/VG2	+ \$22	
Fabric/Vinyl Grade 3	FG3/VG3	+ \$45	
Fabric/Vinyl Grade 4	FG4/VG4	+ \$77	
Fabric/Vinyl Grade 5	FG5/VG5	+ \$116	
Fabric/Vinyl Grade 6	FG6/VG6	+ \$159	
Fabric/Vinyl Grade 7	FG7/VG7	+ \$200	
Seat and Back (For UP)			
COM	COM	+ \$0	
Fabric/Vinyl Grade 1	FG1/VG1	+ \$0	
Fabric/Vinyl Grade 2	FG2/VG2	+ \$34	
Fabric/Vinyl Grade 3	FG3/VG3	+ \$74	
Fabric/Vinyl Grade 4	FG4/VG4	+ \$121	
Fabric/Vinyl Grade 5	FG5/VG5	+ \$174	
Fabric/Vinyl Grade 6	FG6/VG6	+ \$235	
Fabric/Vinyl Grade 7	FG7/VG7	+ \$296	

Please reference the Textile Reference Guide for pricing on fabric over grade 7.

7. Packaging

Packaging	Code	Price	
Fully Assembled in Carton	AC	+ \$0	
Individually Packaged	AC1	+ \$20	

MULTIPURPOSE CHAIR, COUNTER STOOL AND BAR STOOL

CHAIR SPECIFICATIONS

Model:	1011 FT1 4-Leg Multipurpose Chair	1011 FT2 Wire Rod Multipurpose Chair
Overall Width Armless	21.2"	21.2"
Overall Width With Arms	22.2"	22.2"
Overall Depth	21.6"	21.6"
Overall Height	33.4"	33.4"
Seat Width	18.5"	18.5"
Seat Depth	18.2"	18.2"
Seat Height	17.9"	17.9"
Back Width	18.2"	18.2"
Back Height	17.5"	17.5"
Weight Armless	12.3 lb	15.8 lb
Weight With Arms	13.8 lb	17.3 lb
COM	0.85 yd (US) 1 yd (UP)	0.85 yd (US) 1 yd (UP)
Weight Capacity Warranty	300 lb	300 lb

Upholstered seat only (US). Upholstered seat and back (UP).

STOOL SPECIFICATIONS

Model:	1011 S9 24" Counter Stool	1011 S2 30" Bar Stool
Overall Width Armless	21.3"	21.3"
Overall Width With Arms	26.8"	26.8"
Overall Depth	22.1"	22.1"
Overall Height	40"	45.1"
Seat Width	19"	19"
Seat Depth	18.7"	18.7"
Seat Height	24.25"	29.5"
Back Width	18.3"	18.3"
Back Height	16.7"	16.7"
Weight Armless	17 lb	20.3 lb
Weight With Arms	18.7 lb	21.9 lb
COM	0.85 yd (US) 1 yd (UP)	0.85 yd (US) 1 yd (UP)
Weight Capacity Warranty	300 lb	300 lb

Upholstered seat only (US). Upholstered seat and back (UP).

Mika

MULTIPURPOSE CHAIR AND BAR STOOL

Design above.

Mika sits above most others in its class—and not just because it was a multi-award winner. Mika is elevated. Upholstered or non-upholstered, it reaches new heights in what a molded shell chair can be. From top to bottom, the design flows. Back and forth, the design rocks with 15 degrees of flex. Up and up, the design pushes an upholstered seat farther than ever before. And in the end, you arrive at a place of sit-ability and stack-ability hard to find in something that looks this good.



Featured Models

GOOD :: \$300

4-leg, all plastic, armless, standard multi-surface glides

BETTER :: \$376

Wire rod, upholstered seat, armless, no glides, grade 1 textile



BEST :: \$399

4-leg, upholstered seat, armless, standard multi-surface glides, grade 1 textile

Features

- Designed by ITO Design
- Single-piece shell with 15 degrees of backrest flex
- Sculpted shell provides a natural cradle
- Optional $\frac{2}{3}$ upholstered seat available in 15,000+ textiles
- Base options include 4-leg, wire rod and wire rod bar stool
- Three neutral shell colors
- White, black, fog and chrome frame finishes
- Wire rod model stacks up to 30 chairs on a cart
- Upholstered 4-leg model stacks up to nine chairs on the floor
- 300 lb weight capacity warranty

1. Frame

Frame Type	Code	Price	
4-Leg	1101 FT1	\$300	
Wire Rod	1101 FT2	\$277	
30" Wire Rod Bar Stool	1101 FT2 S2	\$427	

Frame Finish	Code	Price	
For 4-Leg Frame (FT1)			
Black	FC1	+ \$0	
Fog	FC13	+ \$0	
White	FC12	+ \$0	
For Wire Rod Frame (FT2)			
Black	FC1	+ \$0	
Chrome	FC15	+ \$0	

MULTIPURPOSE CHAIR AND BAR STOOL

2. Seat

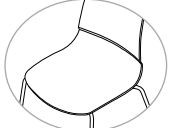
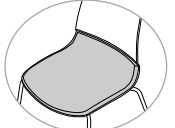
Seat Style	Code	Price	
Plastic Seat	PS	+ \$0	
Upholstered Seat ($\frac{2}{3}$ Upholstered Wrap)	US	+ \$99	

3. Arms

Arm Style	Code	Price	
Armless	AR0	+ \$0	

4. Base

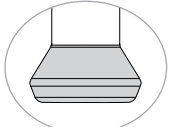
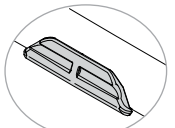
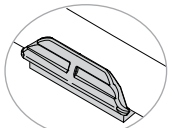
Glides	Code	Price	
For 4-Leg Frame (FT1)			
Standard Multi-Surface Glides	GL1	+ \$0	
For Wire Rod Frame (FT2)			
No Glides	G0	+ \$0	
Clear Glides	CGR	+ \$9	
Clear Glides With Felt	CGRF	+ \$22	

5. Miscellaneous

Accessories	Code	Price	
Stacking Cart	CART	+\$399	

Please use caution when stacking to prevent frame damage. SitOnIt Seating does not warrant scratched frames.

Wire rod bar stools (S2) do not stack on cart.

6. Material

Protection	Code	Price	
CAL 133, Fabric, Quantities 1-49	133F	+\$64	
CAL 133, Fabric, Quantities 50+	133F5	+\$20	
CAL 133, Plastic, Any Quantity	133P	+\$10	

Shell Color	Code	Price	
Black	SC1	+\$0	
White	SC26	+\$0	
Fog	SC27	+\$0	

Seat Textile (For US)	Code	Price	
COM	COM	+\$0	
Fabric/Vinyl Grade 1	FG1/VG1	+\$0	
Fabric/Vinyl Grade 2	FG2/VG2	+\$22	
Fabric/Vinyl Grade 3	FG3/VG3	+\$45	
Fabric/Vinyl Grade 4	FG4/VG4	+\$77	
Fabric/Vinyl Grade 5	FG5/VG5	+\$116	
Fabric/Vinyl Grade 6	FG6/VG6	+\$159	
Fabric/Vinyl Grade 7	FG7/VG7	+\$200	

Please reference the Textile Reference Guide for pricing on fabric over grade 7.

7. Packaging

Packaging	Code	Price	
Fully Assembled in Carton	AC	+\$0	
Fully Assembled in Carton, Individually Packaged	AC1	+\$20	

MULTIPURPOSE CHAIR AND BAR STOOL

SPECIFICATIONS

Model:	1101 FT1 4-Leg Chair	1101 FT2 Wire Rod Chair	1101 FT2 S2 Wire Rod Bar Stool
Overall Width	22.75"	19.65"	19.88"
Overall Depth	19.5"	19.5"	22.9"
Overall Height	32.15"	32.4"	45.75"
Seat Width	17.5"	17.5"	17.5"
Seat Depth	16.75"	16.75"	16.75"
Seat Height	18.5"	18.5"	30.25"
Back Width	16.25"	16.25"	16.25"
Back Height	16.25"	16.25"	16.25"
Weight	15 lb	14.5 lb	19.5"
COM	0.85 yd	0.85 yd	0.85 yd
Maximum Floor Stacking	3 (PS) 9 (US)	3 (PS) 6 (US)	3 (PS) 3 (US)
Maximum Cart Stacking	12 (PS) 12 (US)	30 (PS) 12 (US)	N/A
Weight Capacity Warranty	300 lb	300 lb	300 lb

Plastic seat (PS). Upholstered seat (US).



Good

Movi

NESTER CHAIR

Lean back. Nest easy.

Meet the last nester you'll ever need. Whether you're setting up, breaking down or making space for spontaneous collaboration, today's modern workplace calls for high-design seating solutions that can keep up with it all.

Enter Movi: our ultra-lightweight nester with a slim, modern frame and extra flexibility built right in for long-range comfort all day long.



Featured Models

GOOD :: \$503

Mesh back, upholstered seat, black frame and base, armless, carpet casters, grade 1 textile

BETTER :: \$533

Mesh back, upholstered seat, black frame and base, fixed arms, carpet casters, grade 1 textile

BEST :: \$568

Mesh back, upholstered seat, fog frame and base, fixed arms, carpet casters, grade 1 textile

Features

- Compact, 22.75" of depth
- Nests compactly to save space (53% to be exact)
- Flexes at the hip 14-degrees for enhanced comfort
- Caster design and flip-up seat provide easy nesting
- Movement-friendly back & arm support
- Clean-out space for easy maintenance
- Bleach-cleanable mesh back (10:1)
- 12 mesh colors
- Three base frame and caster colors
- Three back frame and arm colors
- Available as an armless option
- Carpet, hard floor and carpet casters available
- 300 lb weight capacity warranty
- Complements Movi light task chair and stool; see page 112



Best

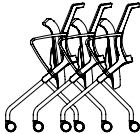

NESTER CHAIR

1. Frame

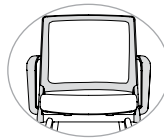
Frame Type	Code	Price	
Nesting	1061 FT4 MB	\$53.3	

Back Frame Finish	Code	Price	
Black	SC1	+\$0	
Fog	SC27	+\$35	
White	SC26	+\$35	

2. Arms

Arm Style	Code	Price	
Armless	AR0	-\$30	
Fixed Arms	AR1	+\$0	

Arms (AR1) will match back frame color.

3. Base

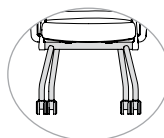
Base Frame and Caster Color	Code	Price	
Black Base With Black Casters	FC1	+\$0	
Silver Base With Fog Casters	FC2	+\$0	
White Base With Fog/White Casters	FC12	+\$0	

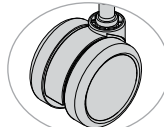
Casters or Glides	Code	Price	
Casters			
Carpet Casters	CS5	+\$0	
Hard Floor and Carpet Casters	CS6	+\$40	

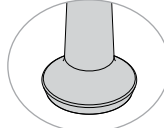
Glides			
Bell Glides (Black)	CS20	+\$30	

4. Material

Protection	Code	Price
CAL 133, Fabric, Quantities 1-49	133F	+ \$99

CAL 133, Fabric, Quantities 50+	133F5	+ \$55
---------------------------------	-------	--------

Mesh Color	Code	Price
------------	------	-------

Apple	MC31	+ \$0
-------	------	-------

Aqua	MC30	+ \$0
------	------	-------

Desert	MC22	+ \$0
--------	------	-------

Electric Blue	MC24	+ \$0
---------------	------	-------

Fire	MC25	+ \$0
------	------	-------

Fog	MC23	+ \$0
-----	------	-------

Grape	MC26	+ \$0
-------	------	-------

Lemon	MC27	+ \$0
-------	------	-------

Nickel	MC21	+ \$0
--------	------	-------

Ocean	MC29	+ \$0
-------	------	-------

Onyx	MC20	+ \$0
------	------	-------

Tangerine	MC28	+ \$0
-----------	------	-------

Seat Textile	Code	Price
--------------	------	-------

COM	COM	+ \$0
-----	-----	-------

Fabric/Vinyl Grade 1	FG1/VG1	+ \$0
----------------------	---------	-------

Fabric/Vinyl Grade 2	FG2/VG2	+ \$22
----------------------	---------	--------

Fabric/Vinyl Grade 3	FG3/VG3	+ \$45
----------------------	---------	--------

Fabric/Vinyl Grade 4	FG4/VG4	+ \$77
----------------------	---------	--------

Fabric/Vinyl Grade 5	FG5/VG5	+ \$116
----------------------	---------	---------

Fabric/Vinyl Grade 6	FG6/VG6	+ \$159
----------------------	---------	---------

Fabric/Vinyl Grade 7	FG7/VG7	+ \$200
----------------------	---------	---------

Please reference the *Textile Reference Guide* for pricing on fabric over grade 7.

5. Packaging

Packaging	Code	Price
-----------	------	-------

Fully Assembled in Carton	AC	+ \$0
---------------------------	----	-------

Individually Packed	AC1	+ \$20
---------------------	-----	--------

NESTER CHAIR

SPECIFICATIONS

Model:	1061 FT4 Nester Chair
Overall Width With Arms	23"
Overall Width Armless	21"
Overall Depth	22.75"
Overall Height	34.62"
Seat Width	19"
Seat Depth	17"
Seat Height	18"
Back Width	18"
Back Height	18"
Weight With Arms	20 lb
Weight Armless	19 lb
COM	0.75 yd
Weight Capacity Warranty	300 lb

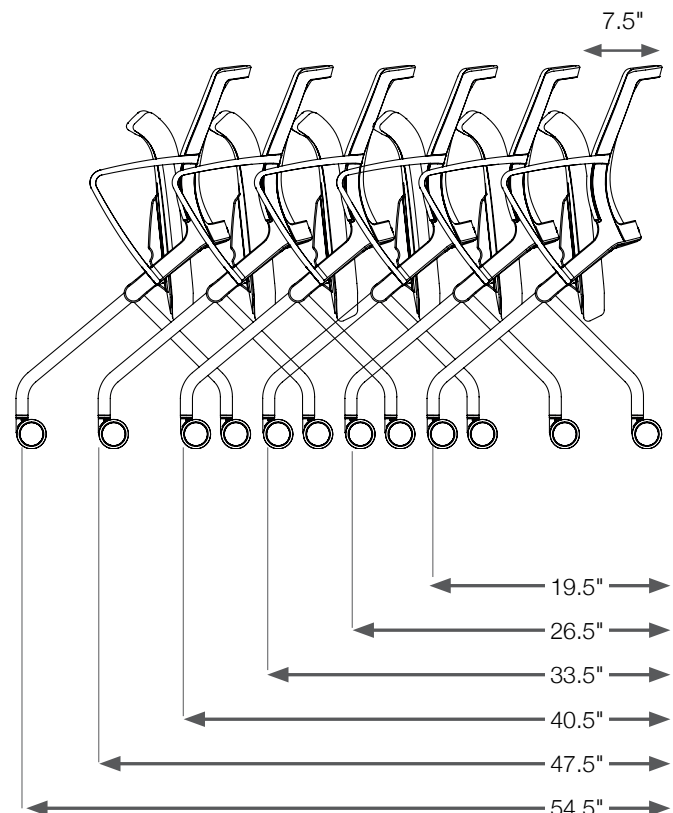

OnCall

MULTIPURPOSE CHAIR AND BAR STOOL

High performance, low maintenance.

Practical, solid wire frame design and stackability make OnCall™ ideal for multipurpose use. It's a value-priced solution for meeting rooms and break areas as well as labs and educational environments. The plastic model offers value while upholstered models ensure a more comfortable sit. A half-circle back cutout serves as a handle to move the side chair or stool anywhere.



Featured Models

GOOD :: \$184

Wire rod chair, all plastic, armless

BETTER :: \$242

Wire rod chair, upholstered seat and plastic back, armless, grade 1 textile



BEST :: \$358

Wire rod chair, upholstered seat and back, fixed arms, grade 1 textile

Features

- Fully upholstered, upholstered seat or plastic
- Nine plastic colors
- Black or chrome frame
- Chair stacks eight on the floor, 20-25 on the optional cart; bar stool stacks four on the floor
- Built-in pull handle
- Wall-saver frame design
- 250 lb weight capacity warranty
- Complements OnCall light task chair and stool; see page 130

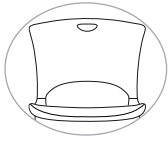
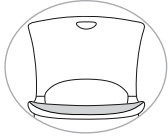
1. Back

Back and Seat Style	Code	Price	
Plastic	No Code	\$184	
Upholstered Seat Only	US	\$242	
Upholstered Seat and Back	UP	\$300	

2. Frame

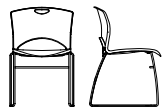
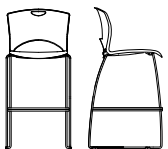

Frame Type	Code	Price	
Wire Rod Side Chair	90	+ \$0	
30" Wire Rod Bar Stool	90 S2	+ \$150	

MULTIPURPOSE CHAIR AND BAR STOOL

2. Frame (Cont.)

Frame Finish	Code	Price	
Black	SB	+ \$0	
Chrome	SC	+ \$0	

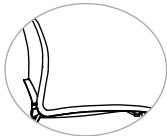
3. Arms

Arm Style	Code	Price	
Armless	A0	+ \$0	
Fixed Cantilever	A37	+ \$58	

Fixed cantilever arms (A37) are not available on the bar stool (90 S2).

4. Base

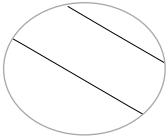
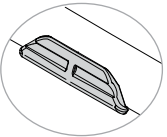
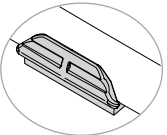
Glides	Code	Price	
No Glides	N	+ \$0	
Clear Glides	CG	+ \$9	
Clear Glides With Felt	CGF	+ \$27	

5. Miscellaneous

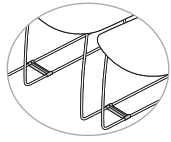
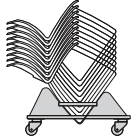
Accessories	Code	Price	
Ganging Bracket for Armless Models	GG3	+ \$12	
Ganging Bracket for Models With Arms	GA3	+ \$12	
Stacking Cart	Cart	+ \$399	

Ganging brackets and stacking carts are not intended for use with wire rod bar stool (S2) models and are compatible with side chair only.

See page 130 for additional stacking requirements.

6. Material

Protection	Code	Price	
CAL 133, Fabric, Quantities 1-49	133F	+ \$99	
CAL 133, Fabric, Quantities 50+	133F5	+ \$55	
CAL 133, Plastic, Any Quantity	133P	+ \$45	

Shell Color	Code	Price	
Arctic	SC21	+ \$0	
Black	SC1	+ \$0	
Chocolate	SC4	+ \$0	
Lagoon	SC15	+ \$0	
Latte	SC20	+ \$0	
Navy	SC5	+ \$0	
Red	SC19	+ \$0	
Slate	SC8	+ \$0	
Sterling	SC18	+ \$0	

Textile	Code	Price	
Seat Only (For US)			
COM	COM	+ \$0	
Fabric/Vinyl Grade 1	FG1/VG1	+ \$0	
Fabric/Vinyl Grade 2	FG2/VG2	+ \$22	
Fabric/Vinyl Grade 3	FG3/VG3	+ \$45	
Fabric/Vinyl Grade 4	FG4/VG4	+ \$77	
Fabric/Vinyl Grade 5	FG5/VG5	+ \$116	
Fabric/Vinyl Grade 6	FG6/VG6	+ \$159	
Fabric/Vinyl Grade 7	FG7/VG7	+ \$200	

MULTIPURPOSE CHAIR AND BAR STOOL

6. Material

Textile (Cont.)	Code	Price	
Seat and Back (For UP)			
COM	COM	+ \$0	
Fabric/Vinyl Grade 1	FG1/VG1	+ \$0	
Fabric/Vinyl Grade 2	FG2/VG2	+ \$34	
Fabric/Vinyl Grade 3	FG3/VG3	+ \$74	
Fabric/Vinyl Grade 4	FG4/VG4	+ \$121	
Fabric/Vinyl Grade 5	FG5/VG5	+ \$174	
Fabric/Vinyl Grade 6	FG6/VG6	+ \$235	
Fabric/Vinyl Grade 7	FG7/VG7	+ \$296	

Please reference the Textile Reference Guide for pricing on fabric over grade 7.

7. Packaging

Packaging	Code	Price	
Fully Assembled in a Carton (Chairs)	AC4	+ \$0	
Fully Assembled in a Carton (Stools)	AC4	+ \$0	
Individually Packaged (Chairs)	AC1	+ \$20	

An additional charge will apply for each additional chair in the AC1 packaging.

SPECIFICATIONS

Model:	90 Wire Rod Multipurpose Chair	90 S2 30" Wire Rod Bar Stool
Overall Width Armless	20"	20"
Overall Width With Arms	24.5"	24.5"
Overall Depth	22.5"	23"
Overall Height	31"	43.5"
Seat Width	18"	18"
Seat Depth	17.5"	17.5"
Seat Height	17.5"	29.5"
Back Width	19.5"	19.5"
Back Height	15"	15"
Weight Armless	11.4 lb (Plastic) 12.4 lb (US)	21.2 lb (Plastic) 22.2 lb (US)
Weight With Arms	14.2 lb (Plastic) 15.2 lb (US)	N/A
COM	0.8 yd (US) 0.85 yd (UP)	0.8 yd (US) 0.85 yd (UP)
Weight Capacity Warranty	250 lb	250 lb

Upholstered seat only (US). Upholstered seat and back (UP).

Qwiz

NESTER CHAIR

Nest brilliantly.

From classrooms to training rooms, the need to get in groups can pop up without warning – and Qwiz® is the perfect answer. It's a smart, fun and versatile nester that makes coming together for collaboration or leaving the room with inspiration quick, easy and comfortable.



Featured Models

GOOD :: \$392

Plastic seat and back, armless, black shell and frame, carpet casters

BETTER :: \$422

Plastic seat and back, fixed arms, black shell and frame, carpet casters

BEST :: \$523

Upholstered seat and back, fixed arms, white shell and frame, carpet casters

Features

- Caster design and flip-up seat for high-density nesting
- Perforated seat and back for breathability
- Three shell and frame colors
- 12 bleach-cleanable mesh back colors
- Upholstered seat or fully upholstered
- Interlocking system for easy ganging
- Available as an armless option
- Performance casters and standard multi-surface glides available
- 300 lb weight capacity warranty

1. Frame

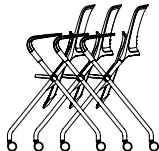
Frame Type	Code	Price	
Nesting	1141 FT4	\$422	

Shell and Frame Finish	Code	Price	
Black	SC1	+ \$0	
Fog	SC27	+ \$35	
White	SC26	+ \$35	

2. Seat

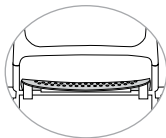
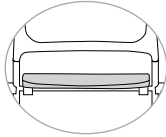
Seat Style	Code	Price	
Plastic Seat	PS	+ \$0	
Upholstered Seat	US	+ \$33	

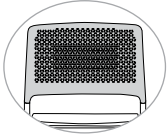
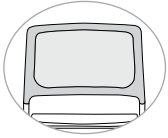
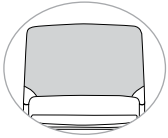

NESTER CHAIR

3. Back

Back Style	Code	Price	
Plastic Back	PB	+ \$0	
Mesh Back	MB	+ \$33	
Upholstered Back	UB	+ \$33	

Upholstered back (UB) is only available with upholstered seat (US).

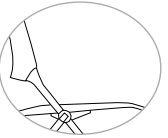
4. Arms

Arm Style	Code	Price	
Armless	AR0	- \$30	
Fixed	AR1	+ \$0	

Arm caps will match shell color.

5. Base

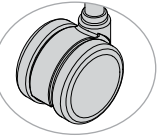
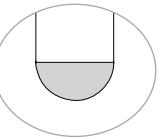
Casters or Glides	Code	Price	
Casters			
Carpet Casters	CS5	+ \$0	
Hard Floor and Carpet Casters	CS6	+ \$40	
Glides			
Standard Multi-Surface Glides	GL1	+ \$30	

Casters, glides and interlock system are black for black shell and frame (SC1) and fog for both fog (SC27) or white (SC26) shells and frames.

6. Material

Mesh Color (For MB)	Code	Price
Apple	MC31	+ \$0
Aqua	MC30	+ \$0
Desert	MC22	+ \$0
Electric Blue	MC24	+ \$0
Fire	MC25	+ \$0
Fog	MC23	+ \$0
Grape	MC26	+ \$0
Lemon	MC27	+ \$0
Nickel	MC21	+ \$0
Ocean	MC29	+ \$0
Onyx	MC20	+ \$0
Tangerine	MC28	+ \$0

NESTER CHAIR

6. Material (Cont.)

Protection	Code	Price
CAL 133, Fabric, Quantities 1-49	133F	+ \$64
CAL 133, Fabric, Quantities 50+	133F5	+ \$20
CAL 133, Plastic, Any Quantity	133P	+ \$10

Textile	Code	Price
Seat Only (For US)		
COM	COM	+ \$0
Fabric/Vinyl Grade 1	FG1/VG1	+ \$0
Fabric/Vinyl Grade 2	FG2/VG2	+ \$22
Fabric/Vinyl Grade 3	FG3/VG3	+ \$45
Fabric/Vinyl Grade 4	FG4/VG4	+ \$77
Fabric/Vinyl Grade 5	FG5/VG5	+ \$116
Fabric/Vinyl Grade 6	FG6/VG6	+ \$159
Fabric/Vinyl Grade 7	FG7/VG7	+ \$200



Better



Best

NESTER CHAIR

6. Material (Cont.)

Textile (Cont.)	Code	Price
Seat and Back (For UB)		
COM	COM	+ \$0
Fabric/Vinyl Grade 1	FG1/VG1	+ \$0
Fabric/Vinyl Grade 2	FG2/VG2	+ \$34
Fabric/Vinyl Grade 3	FG3/VG3	+ \$74
Fabric/Vinyl Grade 4	FG4/VG4	+ \$121
Fabric/Vinyl Grade 5	FG5/VG5	+ \$174
Fabric/Vinyl Grade 6	FG6/VG6	+ \$235
Fabric/Vinyl Grade 7	FG7/VG7	+ \$296

Please reference the *Textile Reference Guide* for pricing on fabric over grade 7.

Due to the nature of vinyl upholstery, nesting may cause impressions on the seat. SitOnIt Seating does not warrant the effects of nesting on vinyl upholstery.

7. Packaging

Packaging	Code	Price
Fully Assembled in Carton, Two Per Carton	AC	+ \$0
Fully Assembled in Carton, Individually Packaged	AC1	+ \$20

SPECIFICATIONS

Model:	1141 FT4 Nester
Overall Width With Arms	22"
Overall Width Armless	22"
Overall Depth	22.5"
Overall Height	32"
Seat Width	16.4"
Seat Depth	17"
Seat Height	17.75" (PS) 18" (US/UB)
Back Width	18.5"
Back Height	15"
Arm Height	25.5"
Weight With Arms	15 lb
Weight Armless	13 lb
COM	0.75 yd (US) 1 yd (US/UB)
Weight Capacity Warranty	300 lb

Plastic seat (PS). Upholstered seat only (US). Upholstered seat and back (US/UB).

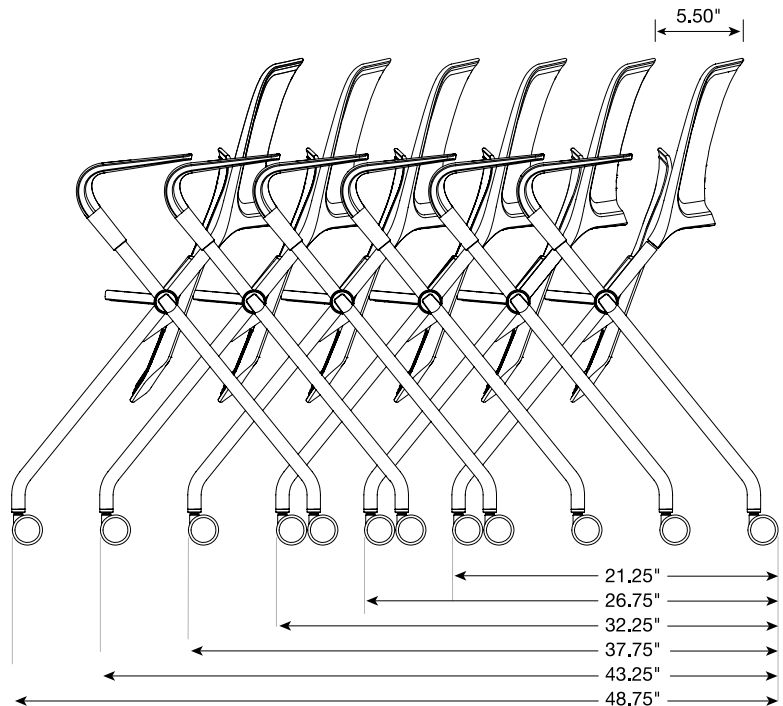

Relay

MULTIPURPOSE CHAIR

Durable and adaptable to the finish.

Great to look at, Relay provides lasting comfort in a stylish design that makes an appealing multipurpose seating option for meeting, training, conference and break rooms. The seat and back are molded from high-impact thermoplastic for lasting durability and comfort. Add the optional upholstered seat and back for a more sophisticated, inviting look and added comfort. Relay side chairs are available in black or silver frame with a caster option.



Featured Models

GOOD :: \$274

All plastic, armless, standard multi-surface glides

BETTER :: \$332

Plastic back, upholstered seat, armless, standard multi-surface glides, grade 1 textile

BEST :: \$448

Upholstered seat and back, fixed cantilever arms, casters, grade 1 textile

Features

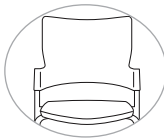
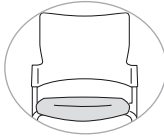
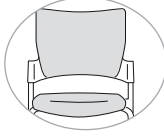

- Structurally reinforced and durable back
- High-impact polypropylene
- Fully upholstered, upholstered seat or plastic
- Nine plastic colors
- 4-leg frame
- Armless or with fixed cantilever arms
- Stacks 5 on the floor, 5 on the optional cart
- Black or silver frame
- Wall-saver frame design
- 250 lb weight capacity warranty
- Complements Relay light task chair and stool; see page 145

1. Back

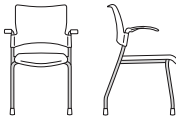

Back and Seat Style	Code	Price	
Plastic	No Code	\$274	
Upholstered Seat Only	US	\$332	
Upholstered Seat and Back	UP	\$390	

MULTIPURPOSE CHAIR

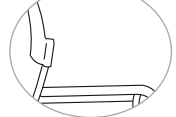
2. Frame

Frame Type and Finish	Code	Price	
Black, 4-Leg	94FB	+ \$0	
Silver, 4-Leg	94FS	+ \$0	
Black, 4-Leg With Black Carpet Casters	94FCB	+ \$40	
Silver, 4-Leg With Black Carpet Casters	94FCS	+ \$40	

3. Arms

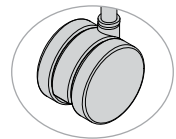
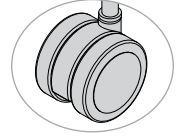
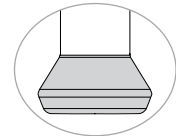

Arm Style	Code	Price	
Armless	A0	+ \$0	
Fixed Cantilever	A60	+ \$58	

4. Base

Casters or Glides	Code	Price	
Casters (For 94FCB / 94FCS)			
Carpet Casters	C13	+ \$0	
Hard Floor and Carpet Casters	C12	+ \$40	
Glides (For 94FB / 94FS)			
Standard Multi-Surface Glides	G9	+ \$0	

Please use caution when stacking models with casters to prevent frame damage. SitOnIt Seating does not warrant scratched frames.

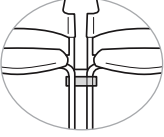
5. Miscellaneous

Accessories	Code	Price	
Ganging Bracket for Armless Models	GG2	+ \$28	
Ganging Bracket for Models With Arms	GA2	+ \$28	
Stacking Cart	14-Cart	+ \$324	

Ganging brackets and stacking carts are not intended for use with caster models and are compatible with glides only. See page 37 for additional stacking requirements.

Due to the nature of upholstery, stacking may cause impressions on the seat. SitOnIt Seating does not warrant the effects of stacking on upholstery.

6. Material

Protection	Code	Price	
CAL 133, Fabric, Quantities 1-49	133F	+ \$99	
CAL 133, Fabric, Quantities 50+	133F5	+ \$55	
CAL 133, Plastic, Any Quantity	133P	+ \$45	
Shell Color	Code	Price	
Arctic	SC21	+ \$0	
Black	SC1	+ \$0	
Chocolate	SC4	+ \$0	
Lagoon	SC15	+ \$0	
Latte	SC20	+ \$0	
Navy	SC5	+ \$0	
Red	SC19	+ \$0	
Slate	SC8	+ \$0	
Sterling	SC18	+ \$0	
Textile	Code	Price	
Seat Only (US)			
COM	COM	+ \$0	
Fabric/Vinyl Grade 1	FG1/VG1	+ \$0	
Fabric/Vinyl Grade 2	FG2/VG2	+ \$22	
Fabric/Vinyl Grade 3	FG3/VG3	+ \$45	
Fabric/Vinyl Grade 4	FG4/VG4	+ \$77	
Fabric/Vinyl Grade 5	FG5/VG5	+ \$116	
Fabric/Vinyl Grade 6	FG6/VG6	+ \$159	
Fabric/Vinyl Grade 7	FG7/VG7	+ \$200	

MULTIPURPOSE CHAIR

6. Material (Cont.)

Textile	Code	Price	
Seat and Back (UP)			
COM	COM	+ \$0	
Fabric/Vinyl Grade 1	FG1/VG1	+ \$0	
Fabric/Vinyl Grade 2	FG2/VG2	+ \$34	
Fabric/Vinyl Grade 3	FG3/VG3	+ \$74	
Fabric/Vinyl Grade 4	FG4/VG4	+ \$121	
Fabric/Vinyl Grade 5	FG5/VG5	+ \$174	
Fabric/Vinyl Grade 6	FG6/VG6	+ \$235	
Fabric/Vinyl Grade 7	FG7/VG7	+ \$296	

Please reference the *Textile Reference Guide* for pricing on fabric over grade 7.

7. Packaging

Packaging	Code	Price	
Fully Assembled in a Carton (4-Leg)	AC4	+ \$0	
Individually Packaged	AC1	+ \$20	

SPECIFICATIONS

Model:	94F 4-Leg Multipurpose Chair	94FC 4-Leg Multipurpose Chair With Casters
Overall Width Armless	21.125"	21.125"
Overall Width With Arms	25.75"	25.75"
Overall Depth	22"	22"
Overall Height	33.5"	33.5"
Seat Width	18.25"	18.25"
Seat Depth	17"	17"
Seat Height	18" (Plastic) 19" (US/UP)	18" (Plastic) 19" (US/UP)
Back Width	19.125"	19.125"
Back Height	17"	17"
Weight Armless	13.5 lb	14 lb
Weight With Arms	14.5 lb	15 lb
COM	0.75 yd (US) 1 yd (UP)	0.75 yd (US) 1 yd (UP)
Weight Capacity Warranty	250 lb	250 lb

Upholstered seat only (US). Upholstered seat and back (UP).

Relay

NESTER CHAIR

Durable and adaptable to the finish.

Great to look at, Relay provides lasting comfort in a stylish design that makes an appealing multipurpose seating option for meeting, training, conference and break rooms. The seat and back are molded from high-impact thermoplastic for lasting durability and comfort. Add the optional upholstered seat and back for a more sophisticated, inviting look and added comfort.

Relay nesting chairs are available in black or silver frame and come with casters standard.



Good

Featured Models

GOOD :: \$314

All plastic, armless, casters

BETTER :: \$372

Plastic back, upholstered seat, armless, casters, grade 1 textile

BEST :: \$488

Upholstered seat and back, fixed cantilever arm, casters, grade 1 textile

Features

- Structurally reinforced and durable back
- High-impact polypropylene
- Fully upholstered, upholstered seat or plastic
- Nine plastic colors
- Armless or with fixed cantilever arms
- Black or silver frame
- 17 chairs in 10 feet of space
- Wall-saver frame design
- 250 lb weight capacity
- Complements Relay light task chair and stool; see page 145

1. Back

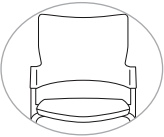
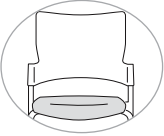
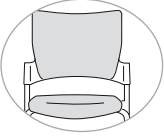

Back and Seat Style	Code	Price	
Plastic	No Code	\$314	
Upholstered Seat Only	US	\$372	
Upholstered Seat and Back	UP	\$430	

2. Frame

Frame Finish	Code	Price	
Black With Black Carpet Casters	94XB	+ \$0	
Silver With Black Carpet Casters	94XS	+ \$0	

NESTER CHAIR

3. Arms

Arm Style	Code	Price	
Armless	A0	+ \$0	
Fixed Cantilever	A60	+ \$58	

4. Base

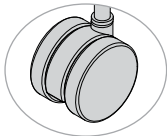
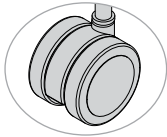
Casters	Code	Price	
Black Carpet Casters	C13	+ \$0	
Hard Floor and Carpet Casters	C12	+ \$40	

5. Miscellaneous

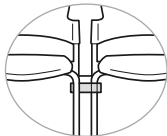
Accessories	Code	Price	
Ganging Bracket for Nester Models	GA10	+ \$28	

6. Material

Protection	Code	Price
CAL 133, Fabric, Quantities 1-49	133F	+ \$99
CAL 133, Fabric, Quantities 50+	133F5	+ \$55
CAL 133, Plastic, Any Quantity	133P	+ \$45

Shell Color	Code	Price
Arctic	SC21	+ \$0
Black	SC1	+ \$0
Chocolate	SC4	+ \$0
Lagoon	SC15	+ \$0
Latte	SC20	+ \$0
Navy	SC5	+ \$0
Red	SC19	+ \$0
Slate	SC8	+ \$0
Sterling	SC18	+ \$0

Textile	Code	Price
Seat Only (US)		
COM	COM	+ \$0
Fabric/Vinyl Grade 1	FG1/VG1	+ \$0
Fabric/Vinyl Grade 2	FG2/VG2	+ \$22
Fabric/Vinyl Grade 3	FG3/VG3	+ \$45
Fabric/Vinyl Grade 4	FG4/VG4	+ \$77
Fabric/Vinyl Grade 5	FG5/VG5	+ \$116
Fabric/Vinyl Grade 6	FG6/VG6	+ \$159
Fabric/Vinyl Grade 7	FG7/VG7	+ \$200
Seat and Back (UP)		
COM	COM	+ \$0
Fabric/Vinyl Grade 1	FG1/VG1	+ \$0
Fabric/Vinyl Grade 2	FG2/VG2	+ \$34
Fabric/Vinyl Grade 3	FG3/VG3	+ \$74
Fabric/Vinyl Grade 4	FG4/VG4	+ \$121
Fabric/Vinyl Grade 5	FG5/VG5	+ \$174
Fabric/Vinyl Grade 6	FG6/VG6	+ \$235
Fabric/Vinyl Grade 7	FG7/VG7	+ \$296

Please reference the Textile Reference Guide for pricing on fabric over grade 7.

7. Packaging

Packaging	Code	Price
Four Per Carton	AC4	+ \$0
Individually Packaged	AC1	+ \$20

NESTER CHAIR

SPECIFICATIONS

	94X Nester Chair
Overall Width Armless	24"
Overall Width With Arms	25.75"
Overall Depth	25.25"
Overall Height	33.5"
Seat Width	18.25"
Seat Depth	17.25"
Seat Height	18.5" (Plastic) 19.5" (US/UP)
Back Width	19.125"
Back Height	17"
Weight Armless	21.5 lb
Weight With Arms	22.5 lb
COM	0.75 yd (US) 1 yd (UP)
Weight Capacity Warranty	250 lb

Upholstered seat only (US). Upholstered seat and back (UP).



Rio

MULTIPURPOSE CHAIR, COUNTER AND BAR STOOL

Design that responds to you.

What goes into the award-winning line of Rio® plastic chairs? Patented flexing technology, for one. Our complete family of Rio models feature our patented Active Rebound Control (ARC) Technology®—a performance-minded flexor insert that supports a wide range of motion (20 full degrees to be exact) and responds precisely to the amount of weight pressed against it.

Add a fresh, modern color palette and you've got a seating solution that allows for more movement, day-long comfort and flexibility than any other chair in its class.

The Rio is an easy choice for multi-use spaces that require quick setups and breakdowns. Discover a collection of stackable chairs engineered to allow for better movement, applications across more environments and a longer product life.



Featured Models

GOOD :: \$210

4-leg chair, plastic seat and back, armless, standard multi-surface glides

BETTER :: \$268

4-leg chair, plastic back, upholstered seat, armless, standard multi-surface glides, grade 1 textile

BEST :: \$384



4-leg chair, seat and back, fixed arms, standard multi-surface glides, grade 1 textile

MULTIPURPOSE CHAIR, COUNTER AND BAR STOOL

Features

- 4-leg, wire rod, 24" counter or 30" bar stool
- Exceptional support and comfort
- Fully upholstered, upholstered seat or plastic
- ARC Technology® for weight-assisted flex
- 14 plastic shell colors
- All models offer two frame finishes with matching arm pads
- Left or right folding tablet arm that match the frame finish.
- Easy-grip edge that acts as pull handle
- Clean-out space
- 4-Leg plastic model stacks four on the floor; eight on the optional cart
- Plastic wire rod model stacks six on the floor; 15 on the optional cart
- 300 lb weight capacity warranty
- Complements Rio light task chair and stool; see page 149

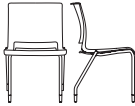
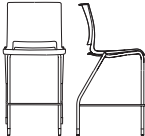
1. Frame

Frame Type	Code	Price	
Wire Rod Chair	1051 FT2	\$200	
4-Leg Chair	1051 FT1	\$210	
24" Counter Stool	1051 FT1 S9	\$360	
30" Bar Stool	1051 FT1 S2	\$360	

1. Frame (Cont.)



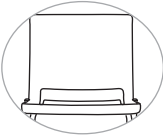
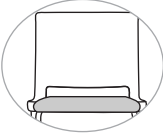
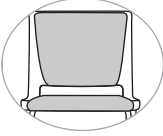

Frame Finish	Code	Price	
Black	FC1	+ \$0	
Silver (4-Leg Frames Only FT1)	FC2	+ \$0	
Chrome (Wire Rod Frame Only FT2)	FC15	+ \$0	

Arms and glides, if selected, are black for black frames and fog for silver or chrome frames.

2. Back

Back and Seat Style	Code	Price	
Plastic Seat	PS	+ \$0	
Upholstered Seat Only	US	+ \$58	
Upholstered Seat and Back	UP	+ \$116	

3. Arms

Arm Style	Code	Price	
Armless	A0	+ \$0	
Fixed Arms (4-Leg Frame Only FT1)	A91	+ \$58	
Fixed Arms (Wire Rod Frame Only FT2)	A131	+ \$58	
Tablet Arm			
Folding Tablet Arm, Left	RMTL	+ \$156	
Folding Tablet Arm, Right	RMTR	+ \$156	

Not available with wire rod (FT1) frames or stools (S9/S2). Not stackable. Tablet arm will be black for black (FC1) frame or fog for silver (FC2) frame.

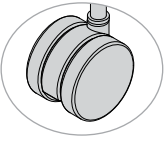
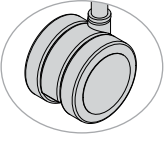
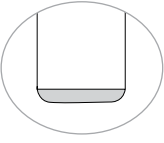
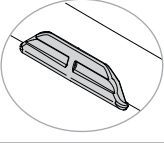
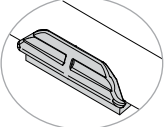

4. Base

Casters or Glides	Code	Price	
Casters			
Carpet Casters	C13	+ \$40	
Hard Floor and Carpet Casters	C12	+ \$80	
Glides for 4-Leg Chair and Stool Only			
Standard Multi-Surface Glides	GL1	+ \$0	
Floor Saver Glides	GL3	+ \$17	
Steel Glides (Carpet Only)	GL4	+ \$17	
Performance Multi-Surface Glides	GL2	+ \$17	
Glides for Wire Rod Frame Only			
No Glides	G0	+ \$0	
Clear Glides	CGR	+ \$9	
Clear Glides With Felt	CGRF	+ \$22	

Please use caution when stacking models with casters to prevent frame damage. SitOnIt Seating does not warrant scratched frames.

MULTIPURPOSE CHAIR, COUNTER AND BAR STOOL

5. Miscellaneous

Accessories	Code	Price	
Ganging Bracket (For 4-Leg Chair FT1)	GG12	+ \$30	
Ganging Bracket (For Wire Rod Armless Models)	GG3	+ \$30	
Ganging Bracket (For Wire Rod Models With Arms)	GA4	+ \$30	
Stacking Cart	Cart	+ \$399	

Ganging brackets and stacking carts are not intended for use with caster models and are compatible with glides only. Accessories are not available for stools (S2/S9).

Due to the nature of upholstery, stacking may cause impressions on the seat. SitOnIt Seating does not warrant the effects of stacking on upholstery.

See page 37 for additional stacking requirements.

6. Material

Protection	Code	Price	
CAL 133, Fabric, Quantities 1-49	133F	+ \$64	
CAL 133, Fabric, Quantities 50+	133F5	+ \$20	
CAL 133, Plastic, Any Quantity	133P	+ \$10	
Shell Color	Code	Price	
Apple	SC24	+ \$0	
Arctic	SC21	+ \$0	
Bisque	SC7	+ \$0	
Black	SC1	+ \$0	
Chocolate	SC4	+ \$0	
Lagoon	SC15	+ \$0	
Latte	SC20	+ \$0	
Lemon	SC25	+ \$0	
Navy	SC5	+ \$0	
Pacific	SC22	+ \$0	
Red	SC19	+ \$0	
Slate	SC8	+ \$0	
Sterling	SC18	+ \$0	
Tangerine	SC23	+ \$0	

6. Material (Cont.)

Textile	Code	Price
Seat Only (US)		
COM	COM	+ \$0
Fabric/Vinyl Grade 1	FG1/VG1	+ \$0
Fabric/Vinyl Grade 2	FG2/VG2	+ \$22
Fabric/Vinyl Grade 3	FG3/VG3	+ \$45
Fabric/Vinyl Grade 4	FG4/VG4	+ \$77
Fabric/Vinyl Grade 5	FG5/VG5	+ \$116
Fabric/Vinyl Grade 6	FG6/VG6	+ \$159
Fabric/Vinyl Grade 7	FG7/VG7	+ \$200
Seat and Back (UP)		
COM	COM	+ \$0
Fabric/Vinyl Grade 1	FG1/VG1	+ \$0
Fabric/Vinyl Grade 2	FG2/VG2	+ \$34
Fabric/Vinyl Grade 3	FG3/VG3	+ \$74
Fabric/Vinyl Grade 4	FG4/VG4	+ \$121
Fabric/Vinyl Grade 5	FG5/VG5	+ \$174
Fabric/Vinyl Grade 6	FG6/VG6	+ \$235
Fabric/Vinyl Grade 7	FG7/VG7	+ \$296

Please reference the Textile Reference Guide for pricing on fabric over grade 7.



MULTIPURPOSE CHAIR, COUNTER AND BAR STOOL

7. Packaging

Packaging	Code	Price
Fully Assembled in Carton	AC	+ \$0
Individually Packaged	AC1	+ \$20

CHAIR SPECIFICATIONS

Model:	1051 FT1 4-Leg Multipurpose Chair	1051 FT2 Wire Rod Multipurpose Chair
Overall Width Armless	21.2"	21.2"
Overall Width With Arms	22.2"	22.2"
Overall Depth	21.6"	23.2"
Overall Height	33.4"	33.4"
Seat Width	18.5"	18.5"
Seat Depth	18.2"	18.2"
Seat Height	17.9"	17.9"
Back Width	18.2"	18.2"
Back Height	17.5"	17.5"
Weight Armless	12.3 lb	15 lb
Weight With Arms	13.8 lb	18 lb
COM	0.85 yd (US) 1 yd (UP)	0.85 yd (US) 1 yd (UP)
Weight Capacity Warranty	300 lb	300 lb

Upholstered seat only (US). Upholstered seat and back (UP).

STOOL SPECIFICATIONS

Model:	1051 FT1 S9 24" 4-Leg Counter Stool	1051 FT1 S2 30" 4-Leg Bar Stool
Overall Width Armless	21.2"	21.2"
Overall Width With Arms	22.2"	22.2"
Overall Depth	22.2"	22.2"
Overall Height	40.35"	45.6"
Seat Width	18.5"	18.5"
Seat Depth	18.2"	18.2"
Seat Height	24.85"	30.1"
Back Width	18.2"	18.2"
Back Height	17.5"	17.5"
Weight Armless	17 lb	20.3 lb
Weight With Arms	18.7 lb	21.9 lb
COM	0.85 yd (US) 1 (UP)	0.85 yd (US) 1 (UP)
Weight Capacity Warranty	300 lb	300 lb

Upholstered seat only (US). Upholstered seat and back (UP).

Rowdy

MULTIPURPOSE CHAIR

Value to shout about.

Rowdy is a one-piece multipurpose chair that will fit any space and any budget. Put Rowdy anywhere from meeting, training and conference rooms to auditorium and theater settings. The built-in hand-hold in the back allows easy repositioning. Stack Rowdy up to 40 high on its optional stacking cart and whisk them away for easy storage when space is at a premium.



Featured Models

GOOD :: \$151

All-plastic seat and back, armless

BETTER :: \$209

Upholstered seat, plastic back, armless

BEST :: \$267

Upholstered seat, plastic back, fixed cantilever arms

Features

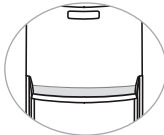

- 14 plastic colors
- Built-in pull handle
- Wire-frame construction
- Black or chrome frame
- All plastic armless model stack 15 on the floor; 40 on the optional cart
- All plastic arm model stack 10 on the floor; 25 on the optional cart
- 250 lb weight capacity warranty

1. Seat

Seat Style	Code	Price	
Plastic	No Code	\$151	
Upholstered Seat	US	\$209	

Do not stack upholstered seats.

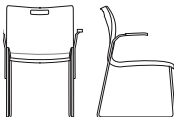
2. Frame

Frame Finish	Code	Price	
Black Wire Rod Base	92 SB	+\$0	
Chrome Wire Rod Base	92 SC	+\$0	

3. Arms

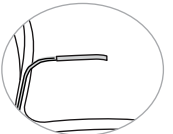
Arm Style	Code	Price	
Armless	A0	+\$0	
Fixed Cantilever Arms	A47	+\$58	

4. Base

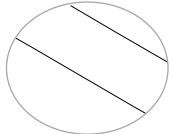
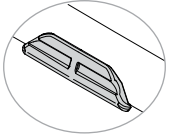
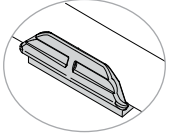
Glides	Code	Price	
No Glides	N	+\$0	
Clear Glides	CGR	+\$9	
Clear Glides With Felt	CGRF	+\$22	

5. Miscellaneous

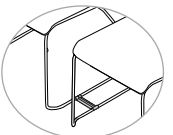
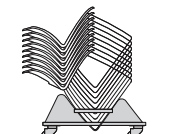
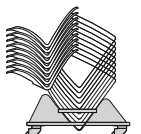
Accessories	Code	Price	
Ganging Bracket for Armless Models	GG5	+\$12	
Ganging Bracket for Models With Arms	GA5	+\$12	
Stacking Cart	CART	+\$399	

Due to the nature of upholstery, stacking may cause impressions on the seat. SitOnIt Seating does not warrant the effects of stacking on upholstery.

See page 37 for additional stacking requirements.

6. Material

Protection	Code	Price
CAL 133 Fabric, Quantities 1-49	133F	+ \$99
CAL 133 Fabric, Quantities 50+	133F5	+ \$55
CAL 133 Plastic, Any Quantity	133P	+ \$45

Shell Color	Code	Price
Apple	SC24	+ \$0
Arctic	SC21	+ \$0
Bisque	SC7	+ \$0
Black	SC1	+ \$0
Chocolate	SC4	+ \$0
Lagoon	SC15	+ \$0
Latte	SC20	+ \$0
Lemon	SC25	+ \$0
Navy	SC5	+ \$0
Pacific	SC22	+ \$0
Red	SC19	+ \$0
Slate	SC8	+ \$0
Sterling	SC18	+ \$0
Tangerine	SC23	+ \$0

Seat Textile (For US)	Code	Price
COM	COM	+ \$0
Fabric/Vinyl Grade 1	FG1/VG1	+ \$0
Fabric/Vinyl Grade 2	FG2/VG2	+ \$22
Fabric/Vinyl Grade 3	FG3/VG3	+ \$45
Fabric/Vinyl Grade 4	FG4/VG4	+ \$77
Fabric/Vinyl Grade 5	FG5/VG5	+ \$116
Fabric/Vinyl Grade 6	FG6/VG6	+ \$159
Fabric/Vinyl Grade 7	FG7/VG7	+ \$200

Please reference the *Textile Reference Guide* for pricing on fabric over grade 7.
Stacking vinyl upholstered seat is not covered by warranty.

7. Packaging

Packaging	Code	Price
Fully Assembled in a Carton	AC4	+ \$0
Three or Fewer (Per Chair)	AC1	+ \$20

MULTIPURPOSE CHAIR

SPECIFICATIONS

Model:	92 Wire Rod Multipurpose Chair
Overall Width Armless	19.5"
Overall Width With Arms	24.5"
Overall Depth	22"
Overall Height	33"
Seat Width	17"
Seat Depth	17"
Seat Height	17.5"
Back Width	19"
Back Height	16"
Weight Armless	13 lb
Weight With Arms	15 lb
COM	0.75 yd (US)
Weight Capacity Warranty	250 lb



Better

Wit Side

MESH BACK MULTIPURPOSE CHAIR

Work smarter.

A slimmer, stationary version of the task chair, our Wit Side is ideal for high-traffic settings like break rooms and cafeterias. Thanks to its ultra-lightweight frame and identical built-in pull handle, you can swing it around and rearrange spaces easily to accommodate the constant flow of crowded areas.



Featured Models

GOOD :: \$240

Mesh back, plastic seat, armless, standard multi-surface glides

BETTER :: \$356

Mesh back, upholstered seat, fixed arms, standard multi-surface glides, grade 1 textile

BEST :: \$411

Mesh back, upholstered seat, fixed arms, black carpet casters, grade 1 textile

Features

- Complements Wit task chair and Wit task stool
- Upholstered seat or plastic seat in nine colors
- 12 mesh back colors
- Built-in pull handle
- Black or silver frame
- Wall-saver frame design
- Textured arm pads
- Stacks four on the floor, four on the optional cart
- Choose from two caster types and four glide options
- 300 lb weight capacity warranty
- Complements by Wit task chair and stool; see pages 173 and 177

1. Frame

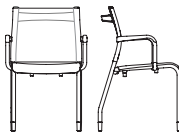
Frame Type	Code	Price	
4-Leg Side	2221 FT1 MB	\$356	
Frame Finish	Code	Price	
Black	FC1	+ \$0	
Silver	FC2	+ \$0	

2. Seat

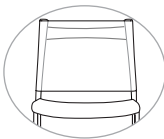
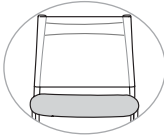
Seat Style	Code	Price	
Plastic Seat	PS	- \$58	
Upholstered Seat	US	+ \$0	

MESH BACK MULTIPURPOSE CHAIR

3. Arms

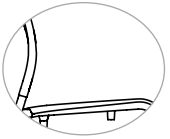
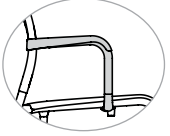

Arm Style	Code	Price	
Armless	AR0	- \$58	
Fixed	AR1	+ \$0	

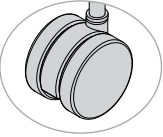
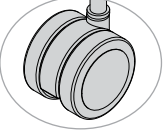
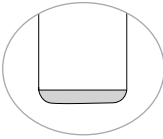
4. Base

Casters or Glides	Code	Price	
Casters			
Black Carpet Casters	CS5	+ \$40	
Hard Floor and Carpet Casters	CS6	+ \$80	
Glides			
Standard Multi-Surface Glides	GL1	+ \$0	
Floor Saver Glides	GL3	+ \$17	
Steel Glides (Carpet Only)	GL4	+ \$17	
Performance Multi-Surface Glides	GL2	+ \$17	

Please use caution when stacking models with casters to prevent frame damage. SitOnIt Seating does not warrant scratched frames.

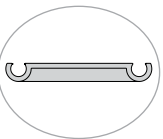
5. Miscellaneous

Accessories	Code	Price	
Ganging Brackets for Armless Models	GG	+ \$30	
Ganging Brackets for Models With Arms	GA	+ \$30	
Stacking Cart	CART	+ \$399	

Stacking cart (CART) is not compatible with caster models (CS5/CS6). See 37 for additional stacking requirements.

Due to the nature of upholstery, stacking may cause impressions on the seat. SitOnIt Seating does not warrant the effects of stacking on upholstery.

6. Material

Protection	Code	Price	
CAL 133, Fabric, Quantities 1-49	133F	+ \$64	
CAL 133, Fabric, Quantities 50+	133F5	+ \$20	
CAL 133, Leather, Any Quantity	133L	+ \$119	
CAL 133, Plastic, Any Quantity	133P	+ \$10	
Mesh Color	Code	Price	
Apple	MC31	+ \$0	
Aqua	MC30	+ \$0	
Desert	MC22	+ \$0	
Electric Blue	MC24	+ \$0	
Fire	MC25	+ \$0	
Fog	MC23	+ \$0	
Grape	MC26	+ \$0	
Lemon	MC27	+ \$0	
Nickel	MC21	+ \$0	
Ocean	MC29	+ \$0	
Onyx	MC20	+ \$0	
Tangerine	MC28	+ \$0	
Shell Color (For PS)	Code	Price	
Arctic	SC21	+ \$0	
Black	SC1	+ \$0	
Chocolate	SC4	+ \$0	
Lagoon	SC15	+ \$0	
Latte	SC20	+ \$0	
Navy	SC5	+ \$0	
Red	SC19	+ \$0	
Slate	SC8	+ \$0	
Sterling	SC18	+ \$0	

MESH BACK MULTIPURPOSE CHAIR

6. Material (Cont.)

Seat Textile Only (For US)	Code	Price	
COM	COM	+ \$0	
Fabric/Vinyl Grade 1	FG1/VG1	+ \$0	
Fabric/Vinyl Grade 2	FG2/VG2	+ \$22	
Fabric/Vinyl Grade 3	FG3/VG3	+ \$45	
Fabric/Vinyl Grade 4	FG4/VG4	+ \$77	
Fabric/Vinyl Grade 5	FG5/VG5	+ \$116	
Fabric/Vinyl Grade 6	FG6/VG6	+ \$159	
Fabric/Vinyl Grade 7	FG7/VG7	+ \$200	
COL	COL	+ \$140	
Leather Grade 1	LG1	+ \$140	
Leather Grade 2	LG2	+ \$200	
Leather Grade 3	LG3	+ \$280	

Please reference the Textile Reference Guide for pricing on fabric over grade 7 or leather over grade 3.



Better

7. Packaging

Packaging	Code	Price
Fully Assembled in a Carton	AC3	+ \$0
Individually Packaged	AC1	+ \$20

SPECIFICATIONS

Model:	2221 FT1 MB Mesh Side Chair	2221 FT1 MB Mesh Side Chair With Casters
Overall Width Armless	19.25"	21.75"
Overall Width With Arms	22.5"	22.5"
Overall Depth	23"	24.5"
Overall Height	33.75"	33.75"
Seat Width	18.5"	18.5"
Seat Depth	16.25"	16.25"
Seat Height	18.07" (PS) 18.53" (US)	18.07" (PS) 18.53" (US)
Back Width	19.25"	19.25"
Back Height	17"	17"
Weight Armless	14 lb (PS) 15.5 lb (US)	14 lb (PS) 15.5 lb (US)
Weight With Arms	18 lb (PS) 19.5 lb (US)	18 lb (PS) 19.5 lb (US)
COM	0.75 yd	0.75 yd
COL	10 sq ft	10 sq ft
Maximum Cart Stacking	4	Not Recommended
Maximum Floor Stacking	4	4
Cart Stacking Weight Armless	112 lb	Not Recommended
Cart Stacking Weight With Arms	128 lb	Not Recommended
Floor Stacking Weight Armless	62 lb	62 lb
Floor Stacking Weight With Arms	78 lb	78 lb
Weight Capacity Warranty	300 lb	300 lb

Plastic seat (PS). Upholstered seat (US).



Wit Side

THINTEX BACK MULTIPURPOSE CHAIR

Work smarter.

A slimmer, stationary version of the task chair, our Wit Side is ideal for high-traffic settings like break rooms and cafeterias. Thanks to its ultra-lightweight frame and identical built-in pull handle, you can swing it around and rearrange spaces easily to accommodate the constant flow of crowded areas.



Featured Models

GOOD :: \$281

Thintex back, plastic seat, armless, standard multi-surface glides

BETTER :: \$397

Thintex back, upholstered seat, fixed arms, standard multi-surface glides, grade 1 textile

BEST :: \$437

Thintex back, upholstered seat, fixed arms, casters, grade 1 textile

Features

- Complements Wit task chair and Wit task stool
- Upholstered seat or plastic seat in nine colors
- 12 Thintex back colors
- Built-in pull handle
- Black or silver frame
- Wall-saver frame design
- Textured arm pads
- Stacks four on the floor, four on the optional cart
- Choose from two caster types and four glide options
- 300 lb weight capacity warranty
- Complements by Wit task chair and stool; see pages 181 and 185

1. Frame

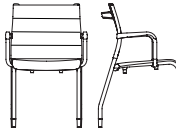
Frame Type	Code	Price	
4-Leg Side	2221 FT1 TXB	\$397	
Frame Finish	Code	Price	
Black	FC1	+ \$0	
Silver	FC2	+ \$0	

2. Back

Back Material	Code	Price	
Fabric	TX1	+ \$0	
Vinyl	TX2	+ \$0	

THINTEX BACK MULTIPURPOSE CHAIR

3. Seat

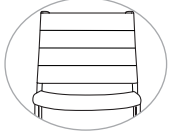
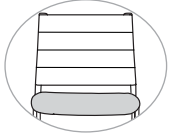
Seat Style	Code	Price	
Plastic Seat	PS	- \$58	
Upholstered Seat	US	+ \$0	

4. Arms

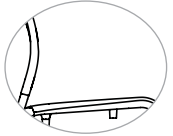
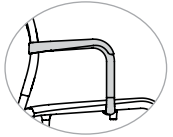

Arm Style	Code	Price	
Armless	AR0	- \$58	
Fixed	AR1	+ \$0	

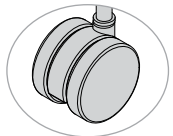
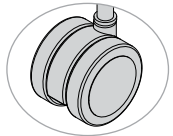
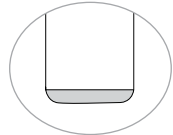
5. Base

Casters or Glides	Code	Price	
Casters			
Black Carpet Casters	CS5	+ \$40	
Hard Floor and Carpet Casters	CS6	+ \$80	
Glides			
Standard Multi-Surface Glides	GL1	+ \$0	
Floor Saver Glides	GL3	+ \$17	
Steel Glides (Carpet Only)	GL4	+ \$17	
Performance Multi-Surface Glides	GL2	+ \$17	

Please use caution when stacking models with casters to prevent frame damage. SitOnIt Seating does not warrant scratched frames.

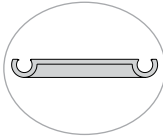
6. Miscellaneous

Accessories	Code	Price	
Ganging Brackets for Armless Models	GG	+ \$30	
Ganging Brackets for Models With Arms	GA	+ \$30	
Stacking Cart	CART	+ \$399	

Stacking cart (CART) is not compatible with caster models (CS5/CS6). See 37 for additional stacking requirements.

Due to the nature of upholstery, stacking may cause impressions on the seat. SitOnIt Seating does not warrant the effects of stacking on upholstery.

7. Material

Protection	Code	Price	
CAL 133, Fabric, Quantities 1-49	133F	+ \$64	
CAL 133, Fabric, Quantities 50+	133F5	+ \$20	
CAL 133, Leather, Any Quantity	133L	+ \$119	
CAL 133, Plastic, Any Quantity	133P	+ \$10	

Thintex Color	Code	Price	
Apple	MC31	+ \$0	
Aqua	MC30	+ \$0	
Desert	MC22	+ \$0	
Electric Blue	MC24	+ \$0	
Fire	MC25	+ \$0	
Fog	MC23	+ \$0	
Grape	MC26	+ \$0	
Lemon	MC27	+ \$0	
Nickel	MC21	+ \$0	
Ocean	MC29	+ \$0	
Onyx	MC20	+ \$0	
Tangerine	MC28	+ \$0	

THINTEX BACK MULTIPURPOSE CHAIR

7. Material (Cont.)

Shell Color (For PS)	Code	Price	
Arctic	SC21	+ \$0	
Black	SC1	+ \$0	
Chocolate	SC4	+ \$0	
Lagoon	SC15	+ \$0	
Latte	SC20	+ \$0	
Navy	SC5	+ \$0	
Red	SC19	+ \$0	
Slate	SC8	+ \$0	
Sterling	SC18	+ \$0	



7. Material (Cont.)

Seat Textile (For US)	Code	Price
COM	COM	+ \$0
Fabric/Vinyl Grade 1	FG1/VG1	+ \$0
Fabric/Vinyl Grade 2	FG2/VG2	+ \$22
Fabric/Vinyl Grade 3	FG3/VG3	+ \$45
Fabric/Vinyl Grade 4	FG4/VG4	+ \$77
Fabric/Vinyl Grade 5	FG5/VG5	+ \$116
Fabric/Vinyl Grade 6	FG6/VG6	+ \$159
Fabric/Vinyl Grade 7	FG7/VG7	+ \$200
COL	COL	+ \$140
Leather Grade 1	LG1	+ \$140
Leather Grade 2	LG2	+ \$200
Leather Grade 3	LG3	+ \$280

Please reference the *Textile Reference Guide* for pricing on fabric over grade 7 or leather over grade 3.



THINTEX BACK MULTIPURPOSE CHAIR

8. Packaging

Packaging	Code	Price
Fully Assembled in a Carton	AC3	+ \$0
Individually Packaged	AC1	+ \$20

SPECIFICATIONS

Model:	2221 FT1 TXB Thintex Side Chair	2221 FT1 TXB Thintex Side Chair With Casters
Overall Width Armless	19.25"	21.75"
Overall Width With Arms	22.5"	22.5"
Overall Depth	23"	24.5"
Overall Height	33.75"	33.75"
Seat Width	18.5"	18.5"
Seat Depth	16.25"	16.25"
Seat Height	18.07" (PS) 18.53" (US)	18.07" (PS) 18.53" (US)
Back Width	19.25"	19.25"
Back Height	17"	17"
Weight Armless	14 lb (PS) 15.5 lb (US)	14 lb (PS) 15.5 lb (US)
Weight With Arms	18 lb (PS) 19.5 lb (US)	18 lb (PS) 19.5 lb (US)
COM	0.75 yd	0.75 yd
COL	10 sq ft	10 sq ft
Maximum Cart Stacking	4	Not Recommended
Maximum Floor Stacking	4	4
Cart Stacking Weight Armless	112 lb	Not Recommended
Cart Stacking Weight With Arms	128 lb	Not Recommended
Floor Stacking Weight Armless	62 lb	62 lb
Floor Stacking Weight With Arms	78 lb	78 lb
Weight Capacity Warranty	300 lb	300 lb

Plastic seat (PS). Upholstered seat (US).

Lounge

CLUB CHAIR | SETTEE | SOFA
MODULAR LOUNGE
TANDEM SEATING | MULTISEATING
LINKING TABLES | COFFEE TABLES

Statement of Line

CLUB CHAIR | SETTEE | SOFA | MODULAR LOUNGE | MULTISEATING
TANDEM SEATING | BARIATRIC | LINKING TABLE | COFFEE TABLE



Aviera
Guest and Bariatric Seating
VRG 270

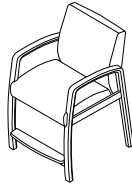

Aviera
Hip Chair
VRG FS3 275



Aviera
Patient Seating
VRP 279

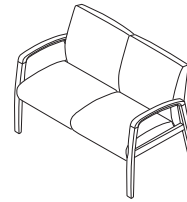

Aviera
Freespan 2-Seat
VRF SN2 284

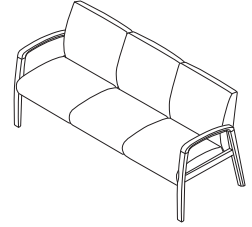

Aviera
Freespan 3-Seat
VRF SN3 284

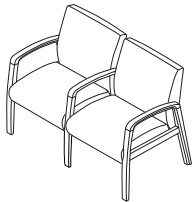

Aviera
Pre-Configured 2-Seat
VRC SN2 289

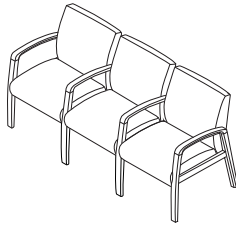

Aviera
Pre-Configured 3-Seat
VRC SN3 289



Aviera
Start Tandem Seating
VRM FS4 294



Aviera
Center/End Tandem Seating
VRM FS5/FS6 294

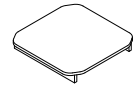

Aviera
Center Linking Table
VRL TTL1 299



Aviera
End Linking Table
VRL TTL3 299



Aviera
Round Corner Linking Table
VRL TTL4 299

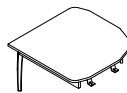

Aviera
Square Corner Linking Table
VRL TTL4 299

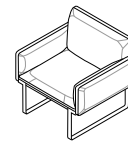

Cameo
Single Seat With Dual Arms
CAM SN1 FS8 302

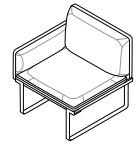

Cameo
Single Seat With Right Arm
CAM SN1 FS10 302

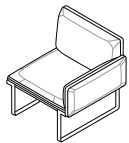

Cameo
Single Seat With Left Arm
CAM SN1 FS12 302

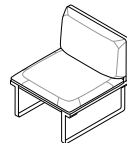

Cameo
Single Seat Armless
CAM SN1 FS17 302

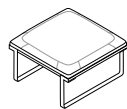

Cameo
Single Seat Bench
CAM SN1 FS2 302

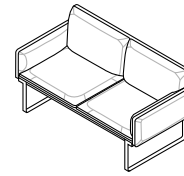

Cameo
2-Seater With Dual Arms
CAM SN2 FS8 302

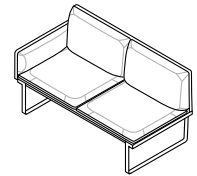

Cameo
2-Seater With Right Arm
CAM SN2 FS10 302

Statement of Line

CLUB CHAIR | SETTEE | SOFA | MODULAR LOUNGE
TANDEM SEATING | MULTISEATING | LINKING TABLE | COFFEE TABLE

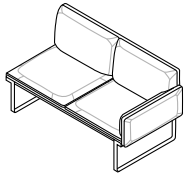

Cameo
2-Seater With Left Arm
CAM SN2 FS12..... 302

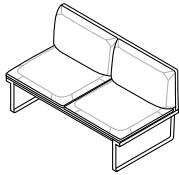

Cameo
2-Seater Armless
CAM SN2 FS17..... 302

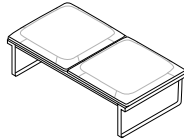

Cameo
2-Seater Bench
CAM SN2 FS2..... 302

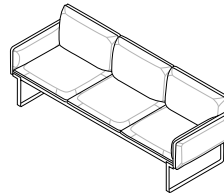

Cameo
3-Seater With Dual Arms
CAM SN3 FS8..... 302

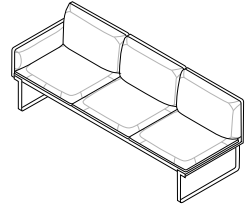

Cameo
3-Seater With Right Arm
CAM SN3 FS10..... 302

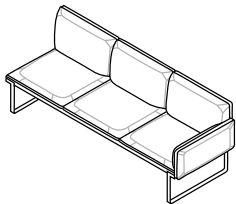

Cameo
3-Seater With Left Arm
CAM SN3 FS12..... 302

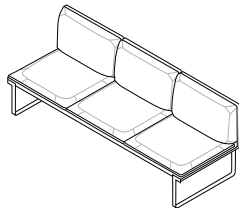

Cameo
3-Seater Armless
CAM SN3 FS17..... 302

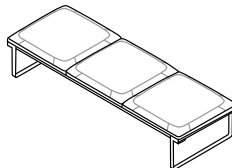

Cameo
3-Seater Bench
CAM SN3 FS2..... 302

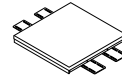

Cameo
Inline Table
CAMT TTL1 307

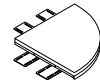

Cameo
Corner Table
CAMT TTL4..... 307

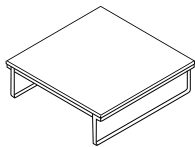

Cameo
Square Coffee Table
CAMT TT8..... 306

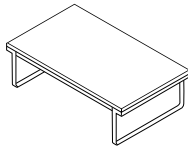

Cameo
Rectangular Coffee Table
CAMT TT9..... 307

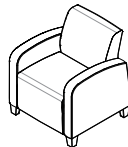

Composium
Curve Club Chair
CP AS3 SN1 309

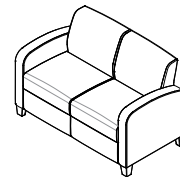

Composium
Curve Settee
CP AS3 SN2 309

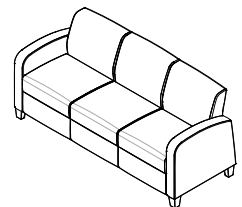

Composium
Curve Sofa
CP AS3 SN3 309

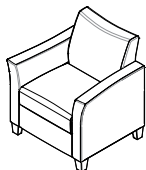

Composium
Flair Club Chair
CP AS2 SN1 314

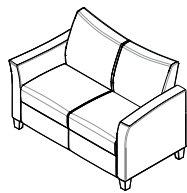

Composium
Flair Settee
CP AS2 SN2 314

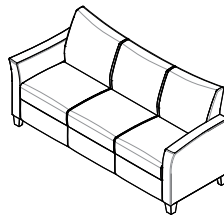

Composium
Flair Sofa
CP AS2 SN3 314

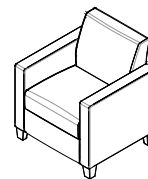

Composium
Sharp Club Chair
CP AS1 SN1 319

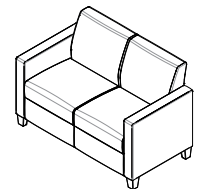

Composium
Sharp Settee
CP AS1 SN2 319

Statement of Line

CLUB CHAIR | SETTEE | SOFA | MODULAR LOUNGE | MULTISEATING
TANDEM SEATING | BARIATRIC | LINKING TABLE | COFFEE TABLE

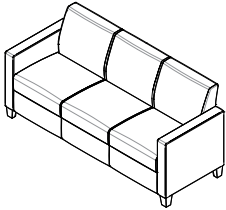

Composium

Sharp Sofa
CP AS1 SN3 319

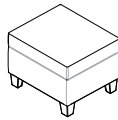

Composium

Ottoman
CP FS1 324

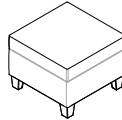

Composium

Single-Seat Bench
CP FS2 SN1 324

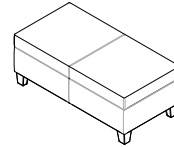

Composium

Double-Seat Bench
CP FS2 SN2 324

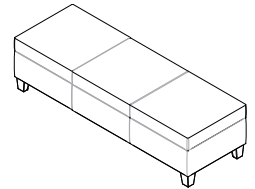

Composium

Three-Seat Bench
CP FS2 SN3 324



Envoi

Midback Lounge Chair
ENV BH4 329



Envoi

Highback Lounge Chair
ENV BH5 329



Gobi

Midback Lounge Chair
GBI BH4 329



Nano

Triangle
NNO FS13 336



Nano

Triangle Table
NNO FS13 TM3/TM4 336



Nano

Diamond
NNO FS14 336



Nano Table

Diamond
NNO FS14 TM3/TM4 336

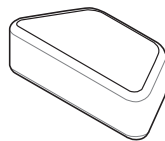

Nano

Trapezoid
NNO FS15 336

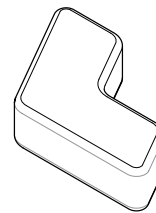

Nano

Trapezoid
NNO FS15 336

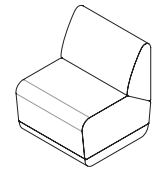

Paséa

Single Seat
PAS FS17 SS1 351

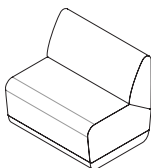

Paséa

1.5 Seat
PAS FS17 SS2 351

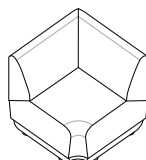

Paséa

90-Degree Corner Seat
PAS FS17 SS5 351

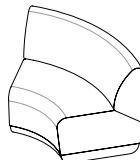

Paséa

90-Degree Corner Seat
PAS FS17 SS5 351

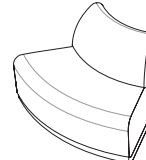

Paséa

90-Degree Corner Seat
PAS FS17 SS5 351

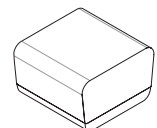

Paséa

90-Degree Corner Seat
PAS FS2 BNS1 351

Statement of Line

CLUB CHAIR | SETTEE | SOFA | MODULAR LOUNGE | MULTISEATING
TANDEM SEATING | BARIATRIC | LINKING TABLE | COFFEE TABLE

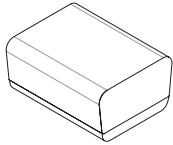

Paséa
90-Degree Corner Seat
PAS FS2 BNS2..... 351

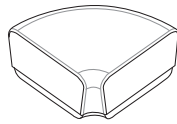

Paséa
90-Degree Corner Seat
PAS FS2 BNS6..... 351

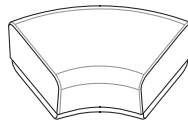

Paséa
120-Degree Bench
PAS FS17 SS5..... 351

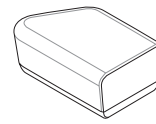

Paséa
Right-Angled End Bench
PAS FS2 BNS3..... 351

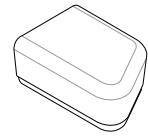

Paséa
Left-Angled End Bench
PAS FS2 BNS4..... 351



Paséa
Mini Round Ottoman
PAS FS1 OS1..... 359



Paséa
Mini Square Ottoman
PAS FS1 OS3..... 359

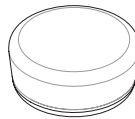

Paséa
Large Round Ottoman
PAS FS1 OS2..... 359



Paséa
Large Square Ottoman
PAS FS1 OS4..... 359

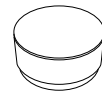

Paséa
Mini Round Table
PAS FS1 OS1 TM3..... 359



Paséa
Mini Square Table
PAS FS1 OS3 TM3..... 359

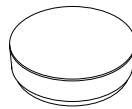

Paséa
Large Round Table
PAS FS1 OS2 TM3..... 359

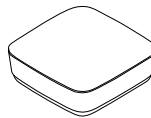

Paséa
Large Square Table
PAS FS1 OS4 TM3..... 359

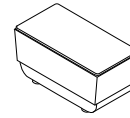

Paséa
13" x 27" Table
FS18 BNS7..... 363

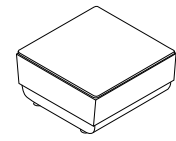

Paséa
27" x 27" Table
FS18 BNS1..... 363

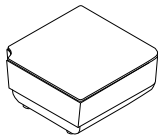

Paséa
90-Degree Corner Table
FS18 BNS5..... 363

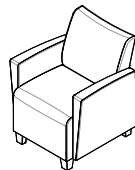

Visit Modular
Club Chair With Two
Upholstered Arms
VS FS8..... 366

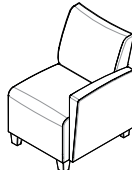

Visit Modular
Club Chair With
Upholstered Left Arm
VS FS12..... 366

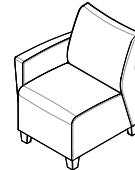

Visit Modular
Club Chair With
Upholstered Right Arm
VS FS10..... 366

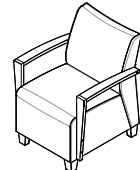

Visit Modular
Club Chair With
Two Wood Arms
VS FS7..... 366

Statement of Line

CLUB CHAIR | SETTEE | SOFA | MODULAR LOUNGE | MULTISEATING
TANDEM SEATING | BARIATRIC | LINKING TABLE | COFFEE TABLE

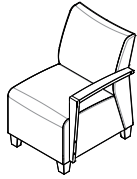

Visit Modular

Club Chair With Wood Left
Arm | VS FS11366

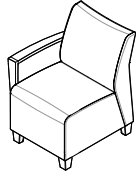

Visit Modular

Club Chair With Wood Right
Arm | VS FS9366

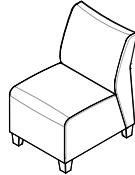

Visit Modular

Armless Club Chair
VS366

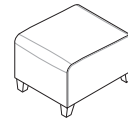

Visit Modular

Ottoman
VS FS1366

Aviera

GUEST AND BARIATRIC SEATING

Comfort that lasts.

Whether lobby, lounge, welcoming or waiting, you can rest easy with supremely comfortable do-it-all seating for your public spaces. Aviera makes it easy to configure endlessly and effortlessly—across an entire collection—with worry-free design and lasting durability, including metal or wood frames that feature an integrated steel structure. Discover an industry-leading seating solution and get peace of mind for any project.



Metal

Featured Models

METAL :: \$1,228

Metal frame, 21" seat, open arms, polyurethane arm caps, multi-upholstery, grade 2 vinyl seat, grade 5 vinyl back

WOOD :: \$1,572

Maple frame, 21" seat, open arms, no arm caps, multi-upholstery, grade 4 vinyl seat, grade 7 vinyl back

BARIATRIC :: \$1,904

Metal frame, 30" seat, open arms, polyurethane arm caps, multi-upholstery, grade 4 vinyl seat, grade 7 fabric back

Features

- Easy ingress and egress with 18.5" seat height and waterfall seat design
- Clean-out space
- Steel-frame construction with metal-to-metal connections
- Beveled, wall-saving frame design
- Two frame materials: Durable aluminum frame or wood frame with silver ion anti-microbial finish
- Three metal frame finishes or four wood frame finishes
- Polyurethane, wood or solid surface arm caps
- Replaceable parts including seat, back, arms, arm caps and arm insets
- 21"/24" seats: 500 lb weight capacity warranty
30"/44" bariatric seats: 750 lb weight capacity warranty



Wood

GUEST AND BARIATRIC SEATING

1. Product

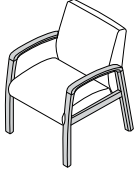

Model	Code	Price	
Guest	VRG	\$848	

2. Frame

Frame Material	Code	Price	
Metal	FM3	+ \$0	
Wood			
Beech	FM2	+ \$10	
Maple	FM1	+ \$68	
Frame Finish	Code	Price	
For Metal Frame			
Silver Metallic	FCM1	+ \$0	
Graphite	FCM2	+ \$0	
Taupe	FCM3	+ \$0	
For Wood Frame			
Clear Maple	FCW1	+ \$0	
Medium Cherry	FCW2	+ \$0	
Amber Mahogany	FCW3	+ \$0	
Espresso	FCW4	+ \$0	
Stain-to-Match	STM	+ \$70	
New Custom Stain	STL	+ \$275	
Frame Options	Code	Price	
Protective Guard Clear Tape	FX1	+ \$84	

New Custom Stain (STL): If stain is not in our library, add this one-time \$275 net fee in addition to the \$70 stain-to-match (STM) cost.

3. Seat

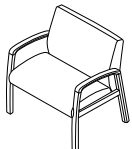
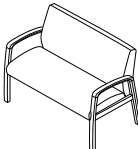
Seat Width	Code	Price	
21"	SW21	+ \$0	
24"	SW24	+ \$55	
Bariatric			
30"	SW30	+ \$275	
44"	SW44	+ \$500	

4. Arms

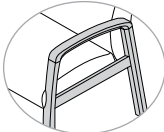
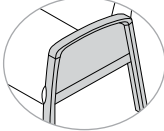
Arm Type	Code	Price	
Open Arm	AT1	+ \$0	
Upholstered Arm	AT2	+ \$86	

GUEST AND BARIATRIC SEATING

4. Arms (Cont.)

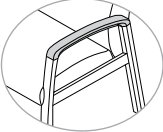
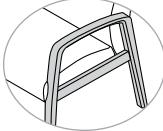
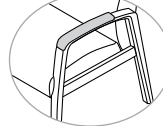
Arm Cap Material	Code	Price	
For Metal Frame			
Polyurethane	ACP4	+ \$0	
Wood	ACP3	+ \$80	
Solid Surface	ACP5	+ \$450	
For Wood Frame			
No Arm Caps	ACP0	+ \$0	
Polyurethane	ACP2	+ \$120	

Arm Cap Finish	Code	Price	
For Polyurethane Arm Caps			
Black	RMC3	+ \$0	
Fog	RMC4	+ \$0	
Dark Grey	RMC5	+ \$0	
For Wood Arm Caps			
Clear Maple	FCW1	+ \$0	
Medium Cherry	FCW2	+ \$0	
Amber Mahogany	FCW3	+ \$0	
Espresso	FCW4	+ \$0	
Stain-to-Match	STM	+ \$70	
New Custom Stain	STL	+ \$275	
For Solid Surface Arm Caps			
Designer White	TSS2	+ \$0	

New Custom Stain (STL): If stain is not in our library, add this one-time \$275 net fee in addition to the \$70 stain-to-match (STM) cost.

Upholstered arm textile will match seat textile.

5. Material

Protection	Code	Price	
CAL 133	UCAL	+ \$100	
Cleaning	Code	Price	
Moisture Barrier Back	UM1	+ \$65	
Moisture Barrier Seat	UM2	+ \$65	
Moisture Barrier Back and Seat	UM3	+ \$130	
Fully Upholstered	Code	Price	
Seat and Back Textile		21"/24"	30"/44"
COM	COM	+ \$0	+ \$0
Fabric/Vinyl Grade 1	FG1/VG1	+ \$0	+ \$0
Fabric/Vinyl Grade 2	FG2/VG2	+ \$60	+ \$100
Fabric/Vinyl Grade 3	FG3/VG3	+ \$150	+ \$220
Fabric/Vinyl Grade 4	FG4/VG4	+ \$275	+ \$365
Fabric/Vinyl Grade 5	FG5/VG5	+ \$415	+ \$525
Fabric/Vinyl Grade 6	FG6/VG6	+ \$575	+ \$705
Fabric/Vinyl Grade 7	FG7/VG7	+ \$735	+ \$885
COL	COL	+ \$600	+ \$685
Leather Grade 1	LG1	+ \$600	+ \$685
Leather Grade 2	LG2	+ \$700	+ \$805
Leather Grade 3	LG3	+ \$800	+ \$1,005
Multi-Upholstery	Code	Price	
		21"/24"	30"/44"
Multi-Upholstery Upcharge	UMU	+ \$113	+ \$113
Seat Textile Only		21"/24"	30"/44"
COM	COM	+ \$0	+ \$0
Fabric/Vinyl Grade 1	FG1/VG1	+ \$0	+ \$0
Fabric/Vinyl Grade 2	FG2/VG2	+ \$26	+ \$42
Fabric/Vinyl Grade 3	FG3/VG3	+ \$63	+ \$93
Fabric/Vinyl Grade 4	FG4/VG4	+ \$116	+ \$154
Fabric/Vinyl Grade 5	FG5/VG5	+ \$175	+ \$221
Fabric/Vinyl Grade 6	FG6/VG6	+ \$242	+ \$297
Fabric/Vinyl Grade 7	FG7/VG7	+ \$309	+ \$372
COL	COL	+ \$252	+ \$288
Leather Grade 1	LG1	+ \$252	+ \$288
Leather Grade 2	LG2	+ \$294	+ \$339
Leather Grade 3	LG3	+ \$336	+ \$423

GUEST AND BARIATRIC SEATING

5. Material (Cont.)

Multi-Upholstery	Code	Price	
Back Textile Only		21"/24"	30"/44"
COM	COM	+ \$0	+ \$0
Fabric/Vinyl Grade 1	FG1/VG1	+ \$0	+ \$0
Fabric/Vinyl Grade 2	FG2/VG2	+ \$35	+ \$58
Fabric/Vinyl Grade 3	FG3/VG3	+ \$87	+ \$128
Fabric/Vinyl Grade 4	FG4/VG4	+ \$160	+ \$212
Fabric/Vinyl Grade 5	FG5/VG5	+ \$241	+ \$305
Fabric/Vinyl Grade 6	FG6/VG6	+ \$334	+ \$409
Fabric/Vinyl Grade 7	FG7/VG7	+ \$427	+ \$514
COL	COL	+ \$348	+ \$398
Leather Grade 1	LG1	+ \$348	+ \$398
Leather Grade 2	LG2	+ \$406	+ \$467
Leather Grade 3	LG3	+ \$464	+ \$583

If different fabrics are selected for the seat and back, add the multi-upholstery upcharge as well, even if the fabrics are the same grade.

Please reference the *Textile Reference Guide* for pricing on fabric over grade 7 and leather over grade 3.

6. Options

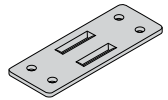
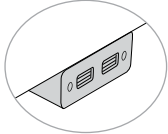
Ganging Brackets	Code	Price	
Ganging Brackets	XGV	+ \$103	
Power Options	Code	Price	
Power, Left	PFL	+ \$250	
Power, Right	PFR	+ \$250	

7. Packaging

Packaging	Code	Price	
Fully Assembled in a Carton	P1	+ \$0	

SPECIFICATIONS

Model:	21"	24"
Height	34.5"	34.5"
Width	24.5"	27.5"
Depth	26.5"	26.5"
Arm Height (Height of Arms From Floor)	25.75"	25.75"
Arm Height (From Seat to Top of Arm)	7.25"	7.25"
Width Between Arms	20.75"	23.75"
Seat Width	21.75"	24.75"
Seat Depth	19"	19"
Seat Height	18.5"	18.5"
Back Height	18.5"	18.5"
Weight	38 lb (FM3) 33 lb (FM1/FM2)	40 lb (FM3) 35 lb (FM1/FM2)
COM (Fully Upholstered)	1.9 yd	1.9 yd
COM (Multi-Upholstery)		
Seat Only	1.2 yd	1.2 yd
Back Only	1.1 yd	1.6 yd
COL (Fully Upholstered)	29.4 sq ft	43.4 sq ft
Weight Capacity Warranty	500 lb	500 lb

Metal frame (FM3), Beech wood frame (FM2), Maple wood frame (FM1).

Yardage requirements for COM and COL are for solid and non-directional fabrics. Additional material may be required for larger repeating patterns.

SPECIFICATIONS: BARIATRIC SIZES

Model:	30"	44"
Height	34.5"	34.5"
Width	33.5"	47.5"
Depth	26.5"	26.5"
Arm Height (Height of Arms From Floor)	25.75"	25.75"
Arm Height (From Seat to Top of Arm)	7.25"	7.25"
Width Between Arms	29.75"	43.75"
Seat Width	30.75"	44.75"
Seat Depth	19"	19"
Seat Height	18.5"	18.5"
Back Height	18.5"	18.5"
Weight	50 lb (FM3) 45 lb (FM1/FM2)	77 lb (FM3) 72 lb (FM1/FM2)
COM (Fully Upholstered)	3.1 yd	3.4 yd
COM (Multi-Upholstery)		
Seat Only	1.2 yd	1.6 yd
Back Only	1.9 yd	1.9 yd
COL (Fully Upholstered)	47.6 sq ft	50.4 sq ft
Weight Capacity Warranty	750 lb	750 lb

Metal frame (FM3), Beech wood frame (FM2), Maple wood frame (FM1).

Yardage requirements for COM and COL are for solid and non-directional fabrics. Additional material may be required for larger repeating patterns.



Bariatric

Aviera

HIP CHAIR

Comfort that lasts.

Whether lobby, lounge, welcoming or waiting, you can rest easy with supremely comfortable do-it-all seating for your public spaces. Aviera makes it easy to configure endlessly and effortlessly—across an entire collection—with worry-free design and lasting durability, including metal or wood frames that feature an integrated steel structure. Discover an industry-leading seating solution and get peace of mind for any project.



Metal

Featured Models

METAL :: \$1,959

Metal frame, 21" seat, open arms, polyurethane arm caps, fully upholstered, grade 7 vinyl seat and back

WOOD :: \$1,874

Maple frame, 21" seat, open arms, no arm caps, multi-upholstery, grade 4 vinyl seat, grade 5 vinyl back

HIP CHAIR

Features

- Easy ingress and egress with waterfall seat design
- Clean-out space
- Steel-frame construction with metal-to-metal connections
- Beveled, wall-saving frame design
- Elevated footrest with a non-slip textured surface
- Two frame materials: Durable aluminum frame or wood frame with silver ion anti-microbial finish
- Three metal frame finishes or four wood frame finishes
- Polyurethane, wood or solid surface arm caps
- Replaceable parts including seat, back, arms, arm caps and arm insets
- 500 lb weight capacity warranty

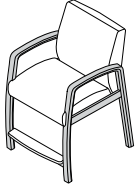

1. Product

Model	Code	Price	
Hip Chair	VRG FS3	\$1,224	

2. Frame

Frame Material	Code	Price	
Metal	FM3	+ \$0	
Wood			
Beech	FM2	+ \$93	
Maple	FM1	+ \$180	
Frame Finish	Code	Price	
For Metal Frame			
Silver Metallic	FCM1	+ \$0	
Graphite	FCM2	+ \$0	
Taupe	FCM3	+ \$0	
For Wood Frame			
Clear Maple	FCW1	+ \$0	
Medium Cherry	FCW2	+ \$0	
Amber Mahogany	FCW3	+ \$0	
Espresso	FCW4	+ \$0	
Stain-to-Match	STM	+ \$70	
New Custom Stain	STL	+ \$275	
Frame Options	Code	Price	
Protective Guard Clear Tape	FX1	+ \$84	

New Custom Stain (STL): If stain is not in our library, add this one-time \$275 net fee in addition to the \$70 stain-to-match (STM) cost.

3. Arms

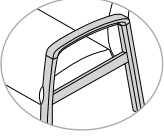
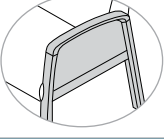
Arm Type	Code	Price	
Open Arm	AT1	+ \$0	
Upholstered Arm	AT2	+ \$86	

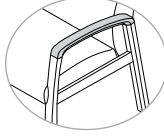
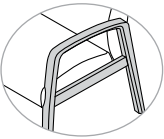
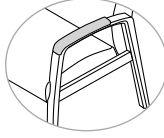
Arm Cap Material	Code	Price	
For Metal Frame			
Polyurethane	ACP4	+ \$0	
Wood	ACP3	+ \$80	
Solid Surface	ACP5	+ \$450	
For Wood Frame			
No Arm Cap	ACP0	+ \$0	
Polyurethane	ACP2	+ \$120	

Arm Cap Finish	Code	Price	
For Polyurethane Arm Caps			
Black	RMC3	+ \$0	
Fog	RMC4	+ \$0	
Dark Grey	RMC5	+ \$0	
For Wood Arm Caps			
Clear Maple	FCW1	+ \$0	
Medium Cherry	FCW2	+ \$0	
Amber Mahogany	FCW3	+ \$0	
Espresso	FCW4	+ \$0	
Stain-to-Match	STM	+ \$70	
New Custom Stain	STL	+ \$275	
For Solid Surface Arm Caps			
Designer White	TSS2	+ \$0	

New Custom Stain (STL): If stain is not in our library, add this one-time \$275 net fee in addition to the \$70 stain-to-match (STM) cost.

Upholstered arm textile will match seat textile.

HIP CHAIR

4. Material

Protection	Code	Price
CAL 133	UCAL	+ \$100

Cleaning	Code	Price
Moisture Barrier Seat	UM2	+ \$65
Moisture Barrier Back	UM1	+ \$65
Moisture Barrier Seat and Back	UM3	+ \$130

Fully Upholstered	Code	Price
COM	COM	+ \$0
Fabric/Vinyl Grade 1	FG1/VG1	+ \$0
Fabric/Vinyl Grade 2	FG2/VG2	+ \$60
Fabric/Vinyl Grade 3	FG3/VG3	+ \$150
Fabric/Vinyl Grade 4	FG4/VG4	+ \$275
Fabric/Vinyl Grade 5	FG5/VG5	+ \$415
Fabric/Vinyl Grade 6	FG6/VG6	+ \$575
Fabric/Vinyl Grade 7	FG7/VG7	+ \$735
COL	COL	+ \$600
Leather Grade 1	LG1	+ \$600
Leather Grade 2	LG2	+ \$700
Leather Grade 3	LG3	+ \$800

Multi-Upholstery	Code	Price
Multi-Upholstery Upcharge	UMU	+ \$113

Seat Textile Only		
COM	COM	+ \$0
Fabric/Vinyl Grade 1	FG1/VG1	+ \$0
Fabric/Vinyl Grade 2	FG2/VG2	+ \$26
Fabric/Vinyl Grade 3	FG3/VG3	+ \$63
Fabric/Vinyl Grade 4	FG4/VG4	+ \$116
Fabric/Vinyl Grade 5	FG5/VG5	+ \$175
Fabric/Vinyl Grade 6	FG6/VG6	+ \$242
Fabric/Vinyl Grade 7	FG7/VG7	+ \$309
COL	COL	+ \$252
Leather Grade 1	LG1	+ \$252
Leather Grade 2	LG2	+ \$294
Leather Grade 3	LG3	+ \$336

4. Material (Cont.)

Multi-Upholstery	Code	Price
Back Textile Only		
COM	COM	+ \$0
Fabric/Vinyl Grade 1	FG1/VG1	+ \$0
Fabric/Vinyl Grade 2	FG2/VG2	+ \$35
Fabric/Vinyl Grade 3	FG3/VG3	+ \$87
Fabric/Vinyl Grade 4	FG4/VG4	+ \$160
Fabric/Vinyl Grade 5	FG5/VG5	+ \$241
Fabric/Vinyl Grade 6	FG6/VG6	+ \$334
Fabric/Vinyl Grade 7	FG7/VG7	+ \$427
COL	COL	+ \$348
Leather Grade 1	LG1	+ \$348
Leather Grade 2	LG2	+ \$406
Leather Grade 3	LG3	+ \$464

If different fabrics are selected for the seat and back, add the multi-upholstery upcharge as well, even if the fabrics are the same grade.

Please reference the *Textile Reference Guide* for pricing on fabric over grade 7 and leather over grade 3.

5. Packaging

Packaging	Code	Price
Fully Assembled in a Carton	P1	+ \$0

HIP CHAIR

SPECIFICATIONS

Model:	VRG FS3 21" Hip Chair
Height	40.25"
Width	24.5"
Depth	28.25"
Arm Height (Height of Arms From Floor)	31.75"
Arm Height (From Seat to Top of Arm)	7.25"
Width Between Arms	20.75"
Seat Width	21.75"
Seat Depth	19"
Seat Height	24.5"
Back Height	18.5"
Footrest Height (From Floor)	7"
Weight	38 lb (FM3) 33 lb (FM1/FM2)
COM (Fully Upholstered)	1.9 yd
COM (Multi-Upholstery)	
Seat Only	1.2 yd
Back Only	1.1 yd
COL (Fully Upholstered)	29.4 sq ft
Weight Capacity Warranty	500 lb

Metal frame (FM3), Beech wood frame (FM2), Maple wood frame (FM1).

Yardage requirements for COM and COL are for solid and non-directional fabrics. Additional material may be required for larger repeating patterns.

Aviera

PATIENT SEATING

Comfort that lasts.

Whether lobby, lounge, welcoming or waiting, you can rest easy with supremely comfortable do-it-all seating for your public spaces. Aviera makes it easy to configure endlessly and effortlessly—across an entire collection—with worry-free design and lasting durability, including metal or wood frames that feature an integrated steel structure. Discover an industry-leading seating solution and get peace-of-mind for any project.



Metal

Featured Models

METAL :: \$1,468

Metal frame, 21" seat, open arms, polyurethane arm caps, multi-upholstery, grade 4 vinyl seat and grade 5 vinyl back

WOOD :: \$1,722

Maple frame, 21" seat, open arms, no arm caps, multi-upholstery, grade 4 vinyl seat and grade 7 vinyl back

BARIATRIC :: \$1,942

Metal frame, 30" seat, open arms, polyurethane arm caps, multi-upholstery, grade 2 vinyl seat and grade 7 fabric back

Features

- Easy ingress and egress with waterfall seat design
- Clean-out space
- Steel-frame construction with metal-to-metal connections
- Beveled, wall-saving frame design
- Two frame materials: Durable aluminum frame or wood frame with silver ion anti-microbial finish
- Three metal frame finishes or four wood frame finishes
- Polyurethane, wood or solid surface arm caps
- Replaceable parts including seat, back, arms, arm caps and arm insets
- 21"/24" seat: 500 lb weight capacity warranty
30" bariatric seat: 750 lb weight capacity warranty



Wood

1. Product



Model	Code	Price	
Aviera Patient	VRP	\$998	

2. Frame

Frame Material	Code	Price	
Metal	FM3	+ \$0	
Wood			
Beech	FM2	+ \$10	
Maple	FM1	+ \$68	
Frame Finish	Code	Price	
For Metal Frame			
Silver Metallic	FCM1	+ \$0	
Graphite	FCM2	+ \$0	
Taupe	FCM3	+ \$0	
For Wood Frame			
Clear Maple	FCW1	+ \$0	
Medium Cherry	FCW2	+ \$0	
Amber Mahogany	FCW3	+ \$0	
Espresso	FCW4	+ \$0	
Stain-to-Match	STM	+ \$70	
New Custom Stain	STL	+ \$275	
Frame Options	Code	Price	
Protective Guard Clear Tape	FX1	+ \$84	

New Custom Stain (STL): If stain is not in our library, add this one-time \$275 net fee in addition to the \$70 stain-to-match (STM) cost.

3. Seat

Seat Width	Code	Price	
21"	SW21	+ \$0	
24"	SW24	+ \$55	
Bariatric			
30"	SW30	+ \$275	

4. Arms

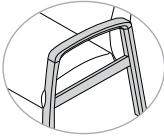
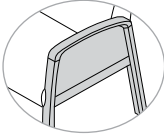
Arm Type	Code	Price	
Open Arm	AT1	+ \$0	
Upholstered Arm	AT2	+ \$86	

Upholstered arm textile will match seat textile.

PATIENT SEATING

4. Arms (Cont.)

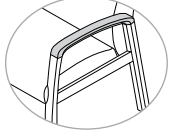
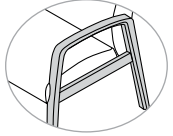
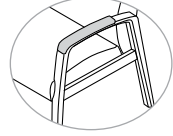
Arm Cap Material	Code	Price	
For Metal Frame			
Polyurethane	ACP4	+ \$0	
Wood	ACP3	+ \$80	
Solid Surface	ACP5	+ \$450	
For Wood Frame			
No Arm Cap	ACP0	+ \$0	
Polyurethane	ACP2	+ \$120	
Arm Cap Finish			
For Polyurethane Arm Caps			
Black	RMC3	+ \$0	
Fog	RMC4	+ \$0	
Dark Grey	RMC5	+ \$0	
For Wood Arm Caps			
Clear Maple	FCW1	+ \$0	
Medium Cherry	FCW2	+ \$0	
Amber Mahogany	FCW3	+ \$0	
Espresso	FCW4	+ \$0	
Stain-to-Match	STM	+ \$70	
New Custom Stain	STL	+ \$275	
For Solid Surface Arm Caps			
Designer White	TSS2	+ \$0	

New Custom Stain (STL): If stain is not in our library, add this one-time \$275 net fee in addition to the \$70 stain-to-match (STM) cost.

5. Material

Protection	Code	Price	
CAL 133	UCAL	+ \$100	
Cleaning	Code	Price	
Moisture Barrier Seat	UM2	+ \$65	
Moisture Barrier Back	UM1	+ \$65	
Moisture Barrier Seat and Back	UM3	+ \$130	
Fully Upholstered	Code	Price	
Seat and Back Textile		21"/24"	30"
COM	COM	+ \$0	+ \$0
Fabric/Vinyl Grade 1	FG1/VG1	+ \$0	+ \$0
Fabric/Vinyl Grade 2	FG2/VG2	+ \$60	+ \$100
Fabric/Vinyl Grade 3	FG3/VG3	+ \$150	+ \$220
Fabric/Vinyl Grade 4	FG4/VG4	+ \$275	+ \$365
Fabric/Vinyl Grade 5	FG5/VG5	+ \$415	+ \$525
Fabric/Vinyl Grade 6	FG6/VG6	+ \$575	+ \$705
Fabric/Vinyl Grade 7	FG7/VG7	+ \$735	+ \$885
COL	COL	+ \$600	+ \$685
Leather Grade 1	LG1	+ \$600	+ \$685
Leather Grade 2	LG2	+ \$700	+ \$805
Leather Grade 3	LG3	+ \$800	+ \$1,005
Multi-Upholstery	Code	Price	
		21"/24"	30"
Multi-Upholstery Upcharge	UMU	+ \$113	+ \$113
Seat Textile Only		21"/24"	30"
COM	COM	+ \$0	+ \$0
Fabric/Vinyl Grade 1	FG1/VG1	+ \$0	+ \$0
Fabric/Vinyl Grade 2	FG2/VG2	+ \$26	+ \$42
Fabric/Vinyl Grade 3	FG3/VG3	+ \$63	+ \$93
Fabric/Vinyl Grade 4	FG4/VG4	+ \$116	+ \$154
Fabric/Vinyl Grade 5	FG5/VG5	+ \$175	+ \$221
Fabric/Vinyl Grade 6	FG6/VG6	+ \$242	+ \$297
Fabric/Vinyl Grade 7	FG7/VG7	+ \$309	+ \$372
COL	COL	+ \$252	+ \$288
Leather Grade 1	LG1	+ \$252	+ \$288
Leather Grade 2	LG2	+ \$294	+ \$339
Leather Grade 3	LG3	+ \$336	+ \$423

5. Material (Cont.)

Multi-Upholstery	Code	Price	
Back Textile Only		21"/24"	30"
COM	COM	+ \$0	+ \$0
Fabric/Vinyl Grade 1	FG1/VG1	+ \$0	+ \$0
Fabric/Vinyl Grade 2	FG2/VG2	+ \$35	+ \$58
Fabric/Vinyl Grade 3	FG3/VG3	+ \$87	+ \$128
Fabric/Vinyl Grade 4	FG4/VG4	+ \$160	+ \$212
Fabric/Vinyl Grade 5	FG5/VG5	+ \$241	+ \$305
Fabric/Vinyl Grade 6	FG6/VG6	+ \$334	+ \$409
Fabric/Vinyl Grade 7	FG7/VG7	+ \$427	+ \$514
COL	COL	+ \$348	+ \$398
Leather Grade 1	LG1	+ \$348	+ \$398
Leather Grade 2	LG2	+ \$406	+ \$467
Leather Grade 3	LG3	+ \$464	+ \$583

If different fabrics are selected for the seat and back, add the multi-upholstery upcharge as well, even if the fabrics are the same grade.

Please reference the *Textile Reference Guide* for pricing on fabric over grade 7 and leather over grade 3.

6. Options

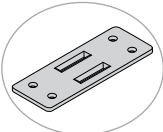
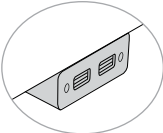
Ganging Brackets	Code	Price	
Ganging Brackets	XGV	+ \$103	
Power Options	Code	Price	
Power, Left	PFL	+ \$250	
Power, Right	PFR	+ \$250	

7. Packaging

Packaging	Code	Price
Fully Assembled in a Carton	P1	+ \$0

SPECIFICATIONS

Model:	VRP SW21 21" Seat	VRP SW24 24" Seat	VRP SW30 30" Seat
Height	44"	44"	44"
Width	24.5"	27.5"	33.5"
Depth	26.5"	26.5"	26.5"
Arm Height (Height of Arms From Floor)	25.75"	25.75"	25.75"
Arm Height (From Seat to Top of Arm)	7.25"	7.25"	7.25"
Width Between Arms	20.75"	23.75"	29.75"
Seat Width	21.75"	24.75"	30.75"
Seat Depth	19"	19"	19"
Seat Height	18.5"	18.5"	18.5"
Back Height	28.5"	28.5"	28.5"
Weight	42 lb (FM3) 37 lb (FM1/FM2)	44 lb (FM3) 39 lb (FM1/FM2)	57 lb (FM3) 52 lb (FM1/FM2)
COM (Fully Upholstered)	2.8 yd	2.8 yd	3.8 yd
COM (Multi-Upholstery)			
Seat Only	1.2 yd	1.2 yd	1.2 yd
Back Only	1.9 yd	2.2 yd	2.5 yd
COL (Fully Upholstered)	35 sq ft	43.4 sq ft	50 sq ft
Weight Capacity	500 lb	500 lb	750 lb
Warranty			

Metal frame (FM3), Beech wood frame (FM2), Maple wood frame (FM1).

Yardage requirements for COM and COL are for solid and non-directional fabrics. Additional material may be required for larger repeating patterns.



Bariatric

Aviera

FREESPAN MULTISEATING

Comfort that lasts.

Whether lobby, lounge, welcoming or waiting, you can rest easy with supremely comfortable do-it-all seating for your public spaces. Aviera makes it easy to configure endlessly and effortlessly—across an entire collection—with worry-free design and lasting durability, including metal or wood frames that feature an integrated steel structure. Discover an industry-leading seating solution and get peace-of-mind for any project.



Metal 2-Seat

Featured Models

METAL 2-SEAT :: \$2,167

Metal frame, 21" seat, open arms, polyurethane arm caps, multi-upholstery, grade 3 vinyl seat and grade 5 vinyl back

WOOD 2-SEAT :: \$2,531

Maple frame, 21" seat, open arms, no arm caps, multi-upholstery, grade 2 vinyl seat and grade 7 fabric back

METAL 3-SEAT :: \$3,341

Metal frame, 24" seat, open arms, solid surface arm caps, multi-upholstery, grade 4 vinyl seat and grade 2 fabric back

Features

- Easy ingress and egress with waterfall seat design
- Clean-out space
- Steel frame construction with metal-to-metal connections
- Beveled, wall-saving frame design
- Two frame materials: Durable aluminum frame or wood frame with silver ion anti-microbial finish
- Three metal frame finishes or four wood frame finishes
- Polyurethane, wood or solid surface arm caps
- Replaceable parts including seat, back, arms, arm caps and arm insets.
- 2-Seat: 525 lb weight capacity warranty
3-Seat: 750 lb weight capacity warranty

1. Product

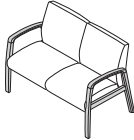
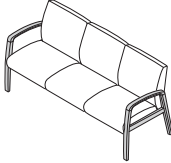
Model	Code	Price	
Aviera 2-Seat Freespan	VRF SN2	\$1,446	
Aviera 3-Seat Freespan	VRF SN3	\$2,161	

FREESPAN MULTISEATING

2. Frame

Frame Material	Code	Price	
Metal	FM3	+ \$0	
Wood			
Beech	FM2	+ \$10	
Maple	FM1	+ \$68	
Center Arm	Code	Price	
No Center Arm	AC0	+ \$0	

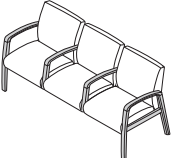
2-Seat With Center Arm	AC1	+ \$30	
3-Seat With Center Arm	AC1	+ \$60	

Frame Finish	Code	Price	
For Metal Frame			
Silver Metallic	FCM1	+ \$0	
Graphite	FCM2	+ \$0	
Taupe	FCM3	+ \$0	
For Wood Frame			
Clear Maple	FCW1	+ \$0	
Medium Cherry	FCW2	+ \$0	
Amber Mahogany	FCW3	+ \$0	
Espresso	FCW4	+ \$0	
Stain-to-Match	STM	+ \$70	
New Custom Stain	STL	+ \$275	
Frame Options	Code	Price	
Protective Guard Clear Tape	FX1	+ \$84	

New Custom Stain (STL): If stain is not in our library, add this one-time \$275 net fee in addition to the \$70 stain-to-match (STM) cost.

3. Seat

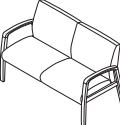
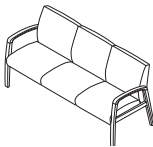
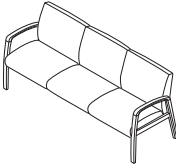
Seat Width	Code	Price	
21", 2-Seat	SW21	+ \$0	
24", 2-Seat	SW21	+ \$0	
21", 3-Seat	SW24	+ \$110	
24", 3-Seat	SW24	+ \$165	

4. Arms

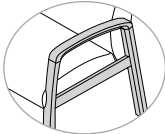
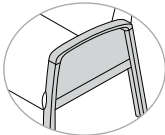
Arm Type	Code	Price	
Open Arm	AT0	+ \$0	
Upholstered Arm, 2-Seat No Center Arm	AT1	+ \$86	
Upholstered Arm, 2-Seat With Center Arm	AT1	+ \$129	
Upholstered Arm, 3-Seat No Center Arm	AT1	+ \$86	
Upholstered Arm, 3-Seat With Center Arm	AT1	+ \$172	

Upholstered arm textile will match seat textile.

FREESPAN MULTISEATING

4. Arms (Cont.)

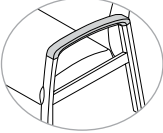
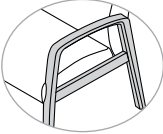
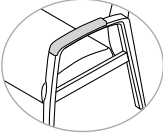
Arm Cap Material	Code	Price	
For Metal Frame			
Polyurethane	ACP4	+ \$0	
Wood, No Center Arm	ACP3	+ \$80	
Wood, 2-Seat With Center Arm	ACP3	+ \$120	
Wood, 3-Seat With Center Arm	ACP3	+ \$160	
Solid Surface No Center Arm	ACP5	+ \$450	
Solid Surface, 2-Seat With Center Arm	ACP5	+ \$675	
Solid Surface, 3-Seat With Center Arm	ACP5	+ \$900	
For Wood Frame			
No Arm Cap	ACP0	+ \$0	
Polyurethane, No Center Arm	ACP2	+ \$120	
Polyurethane, 2-Seat With Center Arm	ACP2	+ \$180	
Polyurethane, 3-Seat With Center Arm	ACP2	+ \$240	
Arm Cap Finish			
For Polyurethane Arm Caps			
Black	RMC3	+ \$0	
Fog	RMC4	+ \$0	
Dark Grey	RMC5	+ \$0	
For Wood Arm Caps			
Clear Maple	FCW1	+ \$0	
Medium Cherry	FCW2	+ \$0	
Amber Mahogany	FCW3	+ \$0	
Espresso	FCW4	+ \$0	
Stain-to-Match	STM	+ \$70	
New Custom Stain	STL	+ \$275	
For Solid Surface Arm Caps			
Designer White	TSS2	+ \$0	

New Custom Stain (STL): If stain is not in our library, add this one-time \$275 net fee in addition to the \$70 stain-to-match (STM) cost.

5. Material

Protection	Code	Price	
CAL 133		2-Seat	3-Seat
CAL 133	UCAL	+\$200	+\$300
Cleaning	Code	Price	
Moisture Barrier		2-Seat	3-Seat
Moisture Barrier Seat	UM2	+\$130	+\$195
Moisture Barrier Back	UM1	+\$130	+\$195
Moisture Barrier Seat and Back	UM3	+\$260	+\$390
Fully Upholstered	Code	Price	
Seat and Back Textile		2-Seat	3-Seat
COM	COM	+\$0	+\$0
Fabric/Vinyl Grade 1	FG1/VG1	+\$0	+\$0
Fabric/Vinyl Grade 2	FG2/VG2	+\$120	+\$180
Fabric/Vinyl Grade 3	FG3/VG3	+\$300	+\$450
Fabric/Vinyl Grade 4	FG4/VG4	+\$550	+\$825
Fabric/Vinyl Grade 5	FG5/VG5	+\$830	+\$1,245
Fabric/Vinyl Grade 6	FG6/VG6	+\$1,150	+\$1,725
Fabric/Vinyl Grade 7	FG7/VG7	+\$1,470	+\$2,205
COL	COL	+\$1,200	+\$1,800
Leather Grade 1	LG1	+\$1,200	+\$1,800
Leather Grade 2	LG2	+\$1,400	+\$2,100
Leather Grade 3	LG3	+\$1,600	+\$2,400
Multi-Upholstery	Code	Price	
		2-Seat	3-Seat
Multi-Upholstery Upcharge	UMU	+\$113	+\$113
Seat Textile Only		2-Seat	3-Seat
COM	COM	+\$0	+\$0
Fabric/Vinyl Grade 1	FG1/VG1	+\$0	+\$0
Fabric/Vinyl Grade 2	FG2/VG2	+\$51	+\$76
Fabric/Vinyl Grade 3	FG3/VG3	+\$126	+\$189
Fabric/Vinyl Grade 4	FG4/VG4	+\$231	+\$347
Fabric/Vinyl Grade 5	FG5/VG5	+\$349	+\$523
Fabric/Vinyl Grade 6	FG6/VG6	+\$483	+\$725
Fabric/Vinyl Grade 7	FG7/VG7	+\$618	+\$927
COL	COL	+\$504	+\$756
Leather Grade 1	LG1	+\$504	+\$756
Leather Grade 2	LG2	+\$588	+\$882
Leather Grade 3	LG3	+\$672	+\$1,008

FREESPAN MULTISEATING

5. Material (Cont.)

Multi-Upholstery	Code	Price	
Back Textile Only		2-Seat	3-Seat
COM	COM	+\$0	+\$0
Fabric/Vinyl Grade 1	FG1/VG1	+\$0	+\$0
Fabric/Vinyl Grade 2	FG2/VG2	+\$70	+\$105
Fabric/Vinyl Grade 3	FG3/VG3	+\$174	+\$261
Fabric/Vinyl Grade 4	FG4/VG4	+\$319	+\$479
Fabric/Vinyl Grade 5	FG5/VG5	+\$482	+\$723
Fabric/Vinyl Grade 6	FG6/VG6	+\$667	+\$1,001
Fabric/Vinyl Grade 7	FG7/VG7	+\$853	+\$1,279
COL	COL	+\$696	+\$1,044
Leather Grade 1	LG1	+\$696	+\$1,044
Leather Grade 2	LG2	+\$812	+\$1,218
Leather Grade 3	LG3	+\$928	+\$1,392

Upholstery prices apply to both 21" and 24" models.

If different fabrics are selected for the seat and back, add the multi-upholstery upcharge as well, even if the fabrics are the same grade.

Please reference the Textile Reference Guide for pricing on fabric over grade 7 and leather over grade 3.

6. Options

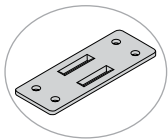
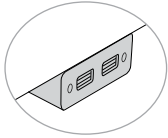
Ganging Brackets	Code	Price	
Ganging Brackets	XGV	+\$103	
Power Options	Code	Price	
Power, Left	PFL	+\$250	
Power, Right	PFR	+\$250	

7. Packaging

Packaging	Code	Price
Fully Assembled in a Carton	P1	+\$0

2-SEAT SPECIFICATIONS

Model:	21"	24"
Height	34.5"	34.5"
Width	46.39" (AC0) 47.28" (AC1)	52.39" (AC0) 53.28" (AC1)
Depth	26.5"	26.5"
Arm Height (Height of Arms From Floor)	25.75"	25.75"
Arm Height (From Seat to Top of Arm)	7.25"	7.25"
Width Between Arms	42.64" (AC0) 20.75" (AC1)	48.64" (AC0) 23.75" (AC1)
Seat Width	21.75"	24.75"
Seat Depth	19"	19"
Seat Height	18.5"	18.5"
Back Height	18.5"	18.5"
Weight	81 lb (FM3+AC0) 85 lb (FM3+AC1) 76 lb (FM1/FM2+AC0) 79 lb (FM1/FM2+AC1)	84 lb (FM3+AC0) 88 lb (FM3+AC1) 79 lb (FM1/FM2+AC0) 82 lb (FM1/FM2+AC1)
COM (Fully Upholstered)	3.8 yd	4.3 yd
COM (Multi-Upholstery)		
Seat Only	1.9 yd	2.2 yd
Back Only	2.1 yd	3.1 yd
COL (Fully Upholstered)	58 sq ft	86 sq ft
Weight Capacity	525 lb	525 lb
Warranty		

Metal frame (FM3), Beech wood frame (FM2), Maple wood frame (FM2).
No center arms (AC0). Center arm (AC1).

Yardage requirements for COM and COL are for solid and non-directional fabrics.
Additional material may be required for larger repeating patterns.

3-SEAT SPECIFICATIONS

Model:	21"	24"
Height	34.5"	34.5"
Width	68.27" (AC0) 70.03" (AC1)	77.27" (AC0) 79.03" (AC1)
Depth	26.5"	26.5"
Arm Height (Height of Arms From Floor)	25.75"	25.75"
Arm Height (From Seat to Top of Arm)	7.25"	7.25"
Width Between Arms	64.52" (AC0) 20.75" (AC1)	73.52" (AC0) 23.75" (AC1)
Seat Width	21.75"	24.75"
Seat Depth	19"	19"
Seat Height	18.5"	18.5"
Back Height	18.5"	18.5"
Weight	104 lb (FM3+AC0) 110 lb (FM3+AC1) 99 lb (FM1/FM2+AC0) 105 lb (FM1/FM2+AC1)	109 lb (FM3+AC0) 117 lb (FM3+AC1) 104 lb (FM1/FM2+AC0) 110 lb (FM1/FM2+AC1)
COM (Fully Upholstered)	5.6 yd	5.9 yd
COM (Multi-Upholstery)		
Seat Only	3 yd	3 yd
Back Only	3.1 yd	4.7 yd
COL (Fully Upholstered)	88.2 sq ft	93 sq ft
Weight Capacity	750 lb	750 lb
Warranty		

Metal frame (FM3), Beech wood frame (FM2), Maple wood frame (FM3).
No center arms (AC0). Center arms (AC1).

Yardage requirements for COM and COL are for solid and non-directional fabrics.
Additional material may be required for larger repeating patterns.



Metal 3-Seat

Aviera

PRECONFIGURED TANDEM MULTISEATING

Comfort that lasts.

Whether lobby, lounge, welcoming or waiting, you can rest easy with supremely comfortable do-it-all seating for your public spaces. Aviera makes it easy to configure endlessly and effortlessly—across an entire collection—with worry-free design and lasting durability, including metal or wood frames that feature an integrated steel structure. Discover an industry-leading seating solution and get peace-of-mind for any project.



Metal 2-Seat

Featured Models

METAL 2-SEAT :: \$2,445

Metal frame, 21" seat, open arms, polyurethane arm caps, multi-upholstery, grade 4 vinyl seat and grade 5 vinyl back

WOOD 2-SEAT :: \$2,738

Maple frame, 21" seat, open arms, no arm caps, multi-upholstery, grade 2 vinyl seat and grade 7 fabric back

METAL 3-SEAT :: \$3,752

Metal frame, 21" seat, open arms, polyurethane arm caps, multi-upholstery, grade 1 vinyl seat and grade 7 vinyl back

Features

- Easy ingress and egress with waterfall seat design
- Clean-out space
- Steel-frame construction with metal-to-metal connections
- Beveled, wall-saving frame design
- Two frame materials: Durable aluminum frame or wood frame with silver ion anti-microbial finish
- Three metal frame finishes or four wood frame finishes
- Polyurethane, wood or solid surface arm caps
- Replaceable parts including seat, back, arms, arm caps and arm insets.
- 500 lb weight capacity (per seat) warranty

1. Product

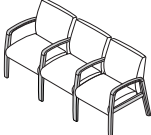
Model	Code	Price	
Aviera 2-Seat Preconfigured	VRC SN2	\$1,619	
Aviera 3-Seat Preconfigured	VRC SN3	\$2,360	

PRECONFIGURED TANDEM MULTISEATING

2. Frame

Frame Material	Code	Price	
Metal	FM3	+ \$0	
Wood			
Beech 2-Seat	FM2	+ \$15	
Beech 3-Seat	FM2	+ \$20	
Maple 2-Seat	FM1	+ \$102	
Maple 3-Seat	FM1	+ \$136	
Frame Finish	Code	Price	
For Metal Frame			
Silver Metallic	FCM1	+ \$0	
Graphite	FCM2	+ \$0	
Taupe	FCM3	+ \$0	
For Wood Frame			
Clear Maple	FCW1	+ \$0	
Medium Cherry	FCW2	+ \$0	
Amber Mahogany	FCW3	+ \$0	
Espresso	FCW4	+ \$0	
Stain-to-Match	STM	+ \$70	
New Custom Stain	STL	+ \$275	



Frame Options	Code	Price	
Protective Guard Clear Tape, 2-Seat	FX1	+ \$126	
Protective Guard Clear Tape, 3-Seat	FX1	+ \$168	

New Custom Stain (STL): If stain is not in our library, add this one-time \$275 net fee in addition to the \$70 stain-to-match (STM) cost.

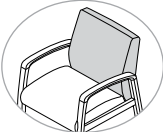
3. Back

Back Height	Code	Price	
Guest Back	BH1	+ \$0	

4. Seat

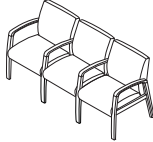
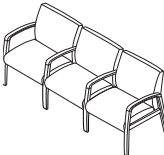
Seat Width	Code	Price	
21", 2-Seat	SW21	+ \$0	
24", 2-Seat	SW24	+ \$110	
21", 3-Seat	SW21	+ \$0	
24", 3-Seat	SW24	+ \$165	

5. Arms

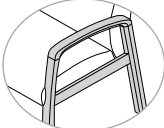
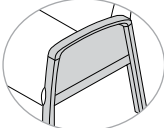

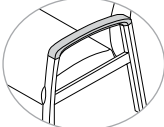
Arm Type	Code	Price	
Open Arm	AT1	+ \$0	
Upholstered Arm, 2-Seat	AT2	+ \$129	
Upholstered Arm, 3-Seat	AT2	+ \$172	

Arm Cap Material	Code	Price	
For Metal Frame			
Polyurethane	ACP4	+ \$0	
Wood, 2-Seat	ACP3	+ \$120	
Wood, 3-Seat	ACP3	+ \$160	
Solid Surface, 2-Seat	ACP5	+ \$675	
Solid Surface, 3-Seat	ACP5	+ \$900	

Upholstered arm textile will match seat textile.

PRECONFIGURED TANDEM MULTISEATING

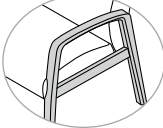
5. Arms (Cont.)

Arm Cap Material	Code	Price	
For Wood Frame			
No Arm Cap	ACP0	+ \$0	
Polyurethane, 2-Seat	ACP2	+ \$180	
Polyurethane, 3-Seat	ACP2	+ \$240	

Arm Cap Finish	Code	Price	
For Polyurethane Arm Caps			
Black	RMC3	+ \$0	
Fog	RMC4	+ \$0	
Dark Grey	RMC5	+ \$0	
For Wood Arm Caps			
Clear Maple	FCW1	+ \$0	
Medium Cherry	FCW2	+ \$0	
Amber Mahogany	FCW3	+ \$0	
Espresso	FCW4	+ \$0	
Stain-to-Match	STM	+ \$70	
New Custom Stain	STL	+ \$275	

For Solid Surface Arm Caps			
Designer White	TSS2	+ \$0	

Upholstered arm textile will match seat textile.

New Custom Stain (STL): If stain is not in our library, add this one-time \$275 net fee in addition to the \$70 stain-to-match (STM) cost.

6. Material

Protection	Code	Price	
CAL 133		2-Seat	3-Seat
CAL 133	UCAL	+ \$200	+ \$300
Cleaning	Code	Price	
Moisture Barrier		2-Seat	3-Seat
Moisture Barrier Back	UM1	+ \$130	+ \$195
Moisture Barrier Seat	UM2	+ \$130	+ \$195
Moisture Barrier Back and Seat	UM3	+ \$260	+ \$390

AVIERA PRECONFIGURED

GSA SIN #: 33721

6. Material (Cont.)

Fully Upholstered		Price	
Code		2-Seat	3-Seat
Seat and Back Textile			
COM	COM	+ \$0	+ \$0
Fabric/Vinyl Grade 1	FG1/VG1	+ \$0	+ \$0
Fabric/Vinyl Grade 2	FG2/VG2	+ \$120	+ \$180
Fabric/Vinyl Grade 3	FG3/VG3	+ \$300	+ \$450
Fabric/Vinyl Grade 4	FG4/VG4	+ \$550	+ \$825
Fabric/Vinyl Grade 5	FG5/VG5	+ \$830	+ \$1,245
Fabric/Vinyl Grade 6	FG6/VG6	+ \$1,150	+ \$1,725
Fabric/Vinyl Grade 7	FG7/VG7	+ \$1,470	+ \$2,205
COL	COL	+ \$1,200	+ \$1,800
Leather Grade 1	LG1	+ \$1,200	+ \$1,800
Leather Grade 2	LG2	+ \$1,400	+ \$2,100
Leather Grade 3	LG3	+ \$1,600	+ \$2,400
Multi-Upholstery		Price	
Code		2-Seat	3-Seat
Multi-Upholstery Upcharge			
UMU	UMU	+ \$113	+ \$113
Seat Textile Only			
COM	COM	+ \$0	+ \$0
Fabric/Vinyl Grade 1	FG1/VG1	+ \$0	+ \$0
Fabric/Vinyl Grade 2	FG2/VG2	+ \$51	+ \$76
Fabric/Vinyl Grade 3	FG3/VG3	+ \$126	+ \$189
Fabric/Vinyl Grade 4	FG4/VG4	+ \$231	+ \$347
Fabric/Vinyl Grade 5	FG5/VG5	+ \$349	+ \$523
Fabric/Vinyl Grade 6	FG6/VG6	+ \$483	+ \$725
Fabric/Vinyl Grade 7	FG7/VG7	+ \$618	+ \$927
COL	COL	+ \$504	+ \$756
Leather Grade 1	LG1	+ \$504	+ \$756
Leather Grade 2	LG2	+ \$588	+ \$882
Leather Grade 3	LG3	+ \$672	+ \$1,008

PRECONFIGURED TANDEM MULTISEATING

6. Material (Cont.)

Multi-Upholstery		Price	
Code		2-Seat	3-Seat
Back Textile Only			
COM	COM	+ \$0	+ \$0
Fabric/Vinyl Grade 1	FG1/VG1	+ \$0	+ \$0
Fabric/Vinyl Grade 2	FG2/VG2	+ \$70	+ \$105
Fabric/Vinyl Grade 3	FG3/VG3	+ \$174	+ \$261
Fabric/Vinyl Grade 4	FG4/VG4	+ \$319	+ \$479
Fabric/Vinyl Grade 5	FG5/VG5	+ \$482	+ \$723
Fabric/Vinyl Grade 6	FG6/VG6	+ \$667	+ \$1,001
Fabric/Vinyl Grade 7	FG7/VG7	+ \$853	+ \$1,279
COL	COL	+ \$696	+ \$1,044
Leather Grade 1	LG1	+ \$696	+ \$1,044
Leather Grade 2	LG2	+ \$812	+ \$1,218
Leather Grade 3	LG3	+ \$928	+ \$1,392

Upholstery prices apply to both 21" and 24" models.

If different fabrics are selected for the seat and back, add the multi-upholstery upcharge as well, even if the fabrics are the same grade.

Please reference the Textile Reference Guide for pricing on fabric over grade 7 and leather over grade 3.

7. Options

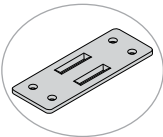
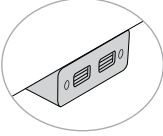
Ganging Brackets	Code	Price	
Ganging Brackets	XGV	+ \$103	
Power Options			
Power, Left	PFL	+ \$250	
Power, Right	PFR	+ \$250	

8. Packaging

Packaging	Code	Price	
Packaging Options		2-Seat	3-Seat
Final Assembly Required	P3	+ \$0	+ \$0
Fully Assembled in a Carton	P1	+ \$200	+ \$325

AVIERA PRECONFIGURED

GSA SIN #: 33721

SPECIFICATIONS: 2-SEAT

Model:	21"	24"
Height	34.5"	34.5"
Width	47.19"	53.19"
Depth	26.5"	26.5"
Arm Height (Height of Arms From Floor)	25.75"	25.75"
Arm Height (From Seat to Top of Arm)	7.25"	7.25"
Width Between Arms	20.75"	23.75"
Seat Width	21.75"	24.75"
Seat Depth	19"	19"
Seat Height	18.5"	18.5"
Back Height	18.5"	18.5"
Weight	38 lb (FM3) 33 lb (FM1/FM2)	40 lb (FM3) 35 lb (FM1/FM2)
COM (Fully Upholstered)	3.8 yd	4.3 yd
COM (Multi-Upholstery)		
Seat Only	1.9 yd	2.2 yd
Back Only	2.1 yd	3.1 yd
COL (Fully Upholstered)	58 sq ft	86 sq ft
Weight Capacity (Per Seat) Warranty	500 lb	500 lb

Metal frame (FM3), Beech wood frame (FM2), Maple wood frame (FM1).

Yardage requirements for COM and COL are for solid and non-directional fabrics. Additional material may be required for larger repeating patterns.

PRECONFIGURED TANDEM MULTISEATING

SPECIFICATIONS: 3-SEAT

Model:	21"	24"
Height	34.5"	34.5"
Width	69.85"	78.85"
Depth	26.5"	26.5"
Arm Height (Height of Arms From Floor)	25.75"	25.75"
Arm Height (From Seat to Top of Arm)	7.25"	7.25"
Width Between Arms	20.75"	20.75"
Seat Width	21.75"	24.75"
Seat Depth	19"	19"
Seat Height	18.5"	18.5"
Back Height	18.5"	18.5"
Weight	99 lb (FM3) 89 lb (FM1/FM2)	104 lb (FM3) 94 lb (FM1/FM2)
COM (Fully Upholstered)	5.6 yd	5.9 yd
COM (Multi-Upholstery)		
Seat Only	3 yd	3 yd
Back Only	3.1 yd	4.7 yd
COL (Fully Upholstered)	88.2 sq ft	93 sq ft
Weight Capacity (Per Seat) Warranty	500 lb	500 lb

Metal frame (FM3), Beech wood frame (FM2), Maple wood frame (FM1).

Yardage requirements for COM and COL are for solid and non-directional fabrics. Additional material may be required for larger repeating patterns.



Wood 2-Seat

Aviera

START/CENTER/END TANDEM MULTISEATING

Comfort that lasts.

Whether lobby, lounge, welcoming or waiting, you can rest easy with supremely comfortable do-it-all seating for your public spaces. Aviera makes it easy to configure endlessly and effortlessly—across an entire collection—with worry-free design and lasting durability, including metal or wood frames that feature an integrated steel structure. Discover an industry-leading seating solution and get peace-of-mind for any project.

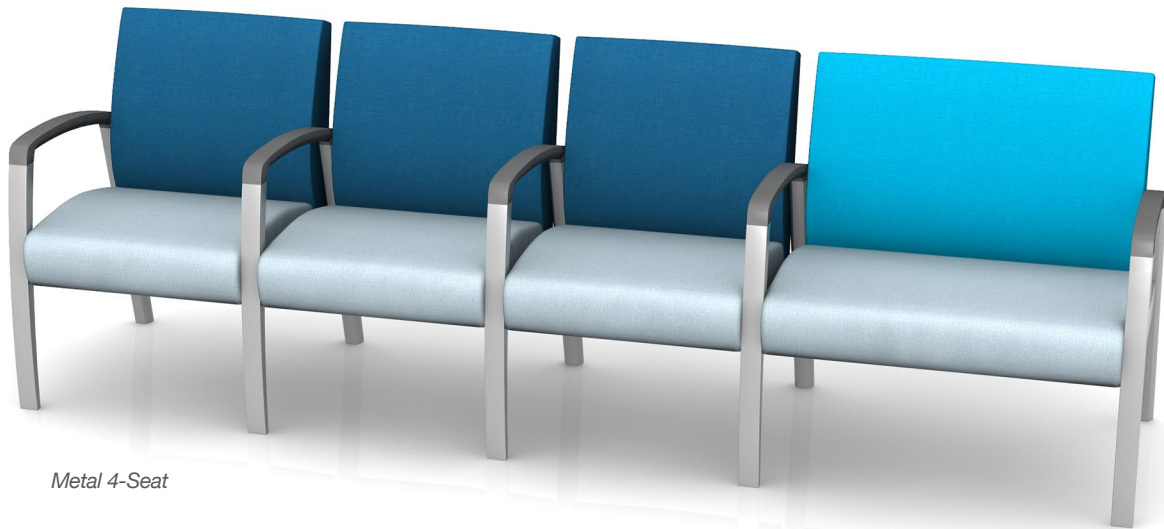

Metal 4-Seat

Featured Models

METAL 3-SEAT :: \$3,627

One 21" start, one 30" center, one 21" end, metal frame, open arms, polyurethane arm caps, multi-upholstery, grade 3 vinyl seat and back

METAL 4-SEAT :: \$4,324

One 21" start, two 21" centers, one 30" end, metal frame, open arms, polyurethane arm caps, multi-upholstery, grade 2 vinyl seat and back

WOOD 5-SEAT :: \$6,001



One 21" start, three 21" centers, one 30" end, maple frame, open arms, no arm caps, multi-upholstery, grade 3 vinyl seat and back

START/CENTER/END TANDEM MULTISEATING

Features

- Start/center/end multiseating is the most versatile and is designed for configurations requiring more than three seats
- Easy ingress and egress with 18.5" seat height and waterfall seat design
- Clean-out space
- Steel-frame construction with metal-to-metal connections
- Beveled, wall-saving frame design
- Two frame materials: Durable aluminum frame or wood frame with silver ion anti-microbial finish
- Three metal frame finishes or four wood frame finishes
- Polyurethane, wood or solid surface arm caps
- Replaceable parts including seat, back, arms, arm caps and arm insets
- 21"/24" seat: 500 lb weight capacity warranty
30"/44" seat: 750 lb weight capacity warranty

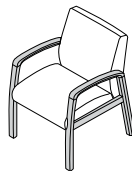
1. Product

Model	Code	Price	
Start	VRM FS4	\$848	
Center	VRM FS5	\$822	
End	VRM FS6	\$822	

2. Frame



Frame Material	Code	Price	
Metal	FM3	+ \$0	
Wood			
Beech, Start	FM2	+ \$10	
Maple, Start	FM1	+ \$68	
Beech, Center or End	FM2	+ \$5	
Maple, Center or End	FM1	+ \$34	
Frame Finish	Code	Price	
For Metal Frame			
Silver Metallic	FCM1	+ \$0	
Graphite	FCM2	+ \$0	
Taupe	FCM3	+ \$0	
For Wood Frame			
Clear Maple	FCW1	+ \$0	
Medium Cherry	FCW2	+ \$0	
Amber Mahogany	FCW3	+ \$0	
Espresso	FCW4	+ \$0	
Stain-to-Match	STM	+ \$70	
New Custom Stain	STL	+ \$275	
Frame Options	Code	Price	
Protective Guard Clear Tape, Start	FX1	+ \$84	
Protective Guard Clear Tape, Center/End	FX1	+ \$42	

New Custom Stain (STL): If stain is not in our library, add this one-time \$275 net fee in addition to the \$70 stain-to-match (STM) cost.

AVIERA START/CENTER/END

GSA SIN #: 33721

3. Seat

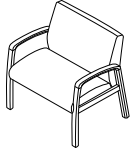
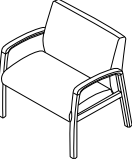
Seat Width	Code	Price	
21"	SW21	+ \$0	
24"	SW24	+ \$55	
Bariatric			
30"	SW30	+ \$275	
44"	SW44	+ \$500	

4. Back

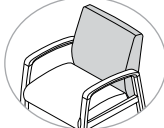
Back Height	Code	Price	
Guest Back	BH1	+ \$0	

5. Arms

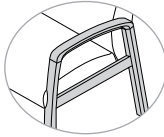
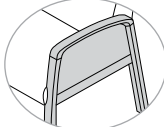
Arm Type	Code	Price	
Open Arm	AT1	+ \$0	
Upholstered Arm, Start	AT2	+ \$86	
Upholstered Arm, Center or End	AT2	+ \$43	

START/CENTER/END TANDEM MULTISEATING

5. Arms (Cont.)

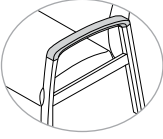
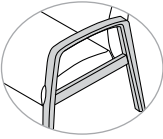
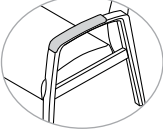
Arm Cap Material	Code	Price	
For Metal Frame			
Polyurethane	ACP4	+ \$0	
Wood, Start	ACP3	+ \$80	
Wood, Center/End	ACP3	+ \$40	
Solid Surface	ACP5	+ \$450	
Solid Surface, Center/End	ACP5	+ \$225	
For Wood Frame			
No Arm Cap	ACP0	+ \$0	
Polyurethane, Start	ACP2	+ \$120	
Polyurethane, Center/End	ACP2	+ \$60	
Arm Cap Finish	Code	Price	
For Polyurethane Arm Caps			
Black	RMC3	+ \$0	
Fog	RMC4	+ \$0	
Dark Grey	RMC5	+ \$0	
For Wood Arm Caps			
Clear Maple	FCW1	+ \$0	
Medium Cherry	FCW2	+ \$0	
Amber Mahogany	FCW3	+ \$0	
Espresso	FCW4	+ \$0	
Stain-to-Match	STM	+ \$70	
New Custom Stain	STL	+ \$275	
For Solid Surface Arm Caps			
Designer White	TSS2	+ \$0	

New Custom Stain (STL): If stain is not in our library, add this one-time \$275 net fee in addition to the \$70 stain-to-match (STM) cost.

6. Material

Protection	Code	Price	
CAL 133		21"/24"	30"/44"
CAL 133	UCAL	+ \$100	+ \$100
Cleaning	Code	Price	
Moisture Barrier		21"/24"	30"/44"
Moisture Barrier Seat	UM2	+ \$65	+ \$65
Moisture Barrier Back	UM1	+ \$65	+ \$65
Moisture Barrier Seat and Back	UM3	+ \$130	+ \$130
Fully Upholstered	Code	Price	
Seat and Back Textile		21"/24"	30"/44"
COM	COM	+ \$0	+ \$0
Fabric/Vinyl Grade 1	FG1/VG1	+ \$0	+ \$0
Fabric/Vinyl Grade 2	FG2/VG2	+ \$60	+ \$100
Fabric/Vinyl Grade 3	FG3/VG3	+ \$150	+ \$220
Fabric/Vinyl Grade 4	FG4/VG4	+ \$275	+ \$365
Fabric/Vinyl Grade 5	FG5/VG5	+ \$415	+ \$525
Fabric/Vinyl Grade 6	FG6/VG6	+ \$575	+ \$705
Fabric/Vinyl Grade 7	FG7/VG7	+ \$735	+ \$885
COL	COL	+ \$600	+ \$685
Leather Grade 1	LG1	+ \$600	+ \$685
Leather Grade 2	LG2	+ \$700	+ \$805
Leather Grade 3	LG3	+ \$800	+ \$1,005
Multi-Upholstery	Code	Price	
		21"/24"	30"/44"
Multi-Upholstery Upcharge	UMU	+ \$113	+ \$113
Seat Textile Only		21"/24"	30"/44"
COM	COM	+ \$0	+ \$0
Fabric/Vinyl Grade 1	FG1/VG1	+ \$0	+ \$0
Fabric/Vinyl Grade 2	FG2/VG2	+ \$26	+ \$42
Fabric/Vinyl Grade 3	FG3/VG3	+ \$63	+ \$93
Fabric/Vinyl Grade 4	FG4/VG4	+ \$116	+ \$154
Fabric/Vinyl Grade 5	FG5/VG5	+ \$175	+ \$221
Fabric/Vinyl Grade 6	FG6/VG6	+ \$242	+ \$297
Fabric/Vinyl Grade 7	FG7/VG7	+ \$309	+ \$372
COL	COL	+ \$252	+ \$288
Leather Grade 1	LG1	+ \$252	+ \$288
Leather Grade 2	LG2	+ \$294	+ \$339
Leather Grade 3	LG3	+ \$336	+ \$423

START/CENTER/END TANDEM MULTISEATING

6. Material (Cont.)

Upholstery	Code	Price	
Back Textile Only		21"/24"	30"/44"
COM	COM	+ \$0	+ \$0
Fabric/Vinyl Grade 1	FG1/VG1	+ \$0	+ \$0
Fabric/Vinyl Grade 2	FG2/VG2	+ \$35	+ \$58
Fabric/Vinyl Grade 3	FG3/VG3	+ \$87	+ \$128
Fabric/Vinyl Grade 4	FG4/VG4	+ \$160	+ \$212
Fabric/Vinyl Grade 5	FG5/VG5	+ \$241	+ \$305
Fabric/Vinyl Grade 6	FG6/VG6	+ \$334	+ \$409
Fabric/Vinyl Grade 7	FG7/VG7	+ \$427	+ \$514
COL	COL	+ \$348	+ \$398
Leather Grade 1	LG1	+ \$348	+ \$398
Leather Grade 2	LG2	+ \$406	+ \$467
Leather Grade 3	LG3	+ \$464	+ \$583

If different fabrics are selected for the seat and back, add the multi-upholstery upcharge as well, even if the fabrics are the same grade.

Please reference the Textile Reference Guide for pricing on fabric over grade 7 and leather over grade 3.

7. Power

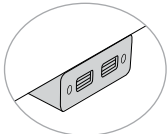
Power Options	Code	Price	
Power, Left	PFL	+ \$250	
Power, Right	PFR	+ \$250	

8. Packaging

Packaging	Code	Price
Fully Assembled in a Carton	P1	+ \$0

START/CENTER/END TANDEM MULTISEATING

SPECIFICATIONS

Model:	21"	24"
Height	34.5"	34.5"
Width	24.5" (FS4) 22.66" (FS5/FS6)	27.5 (FS4) 25.66" (FS5/FS6)
Depth	26.5"	26.5"
Arm Height (Height of Arms From Floor)	25.75"	25.75"
Arm Height (From Seat to Top of Arm)	7.25"	7.25"
Width Between Arms	20.75"	23.75"
Seat Width	21.75"	24.75"
Seat Depth	19"	19"
Seat Height	18.5"	18.5"
Back Height	18.5"	18.5"
Weight	38 lb (FM3) 33 lb (FM1/FM2)	40 lb (FM3) 35 lb (FM1/FM2)
COM (Fully Upholstered)	1.9 yd	1.9 yd
COM (Multi-Upholstery)		
Seat Only	1.2 yd	1.2 yd
Back Only	1.1 yd	1.6 yd
COL (Fully Upholstered)	29.4 sq ft	43.4 sq ft
Weight Capacity Warranty	500 lb	500 lb

Start (FS4). Center (FS5). End (FS6). Metal frame (FM3). Beech wood frame (FM1), Maple wood frame (FM2).

Yardage requirements for COM and COL are for solid and non-directional fabrics. Additional material may be required for larger repeating patterns.

SPECIFICATIONS: BARIATRIC SIZES

Model:	30"	44"
Height	34.5"	34.5"
Width	33.5" (FM4) 31.66" (FS5/FS6)	47.5 (FM4) 45.66" (FS5/FS6)
Depth	26.5"	26.5"
Arm Height (Height of Arms From Floor)	25.75"	25.75"
Arm Height (From Seat to Top of Arm)	7.25"	7.25"
Width Between Arms	29.75"	43.75"
Seat Width	30.75"	44.75"
Seat Depth	19"	19"
Seat Height	18.5"	18.5"
Back Height	18.5"	18.5"
Weight	50 lb (FM3+BH1) 45 lb (FM1/FM2+BH1)	77 lb (FM3+BH1) 73 lb (FM1/FM2+BH1)
COM (Fully Upholstered)	3.1 yd	3.4 yd
COM (Multi-Upholstery)		
Seat Only	1.2 yd	1.6 yd
Back Only	1.9 yd	1.9 yd
COL (Fully Upholstered)	47.6 sq ft	50.4 sq ft
Weight Capacity Warranty	750 lb	750 lb

Start (FS4). Center (FS5). End (FS6). Metal frame (FM3). Beech wood frame (FM1), Maple wood frame (FM2).

Yardage requirements for COM and COL are for solid and non-directional fabrics. Additional material may be required for larger repeating patterns.

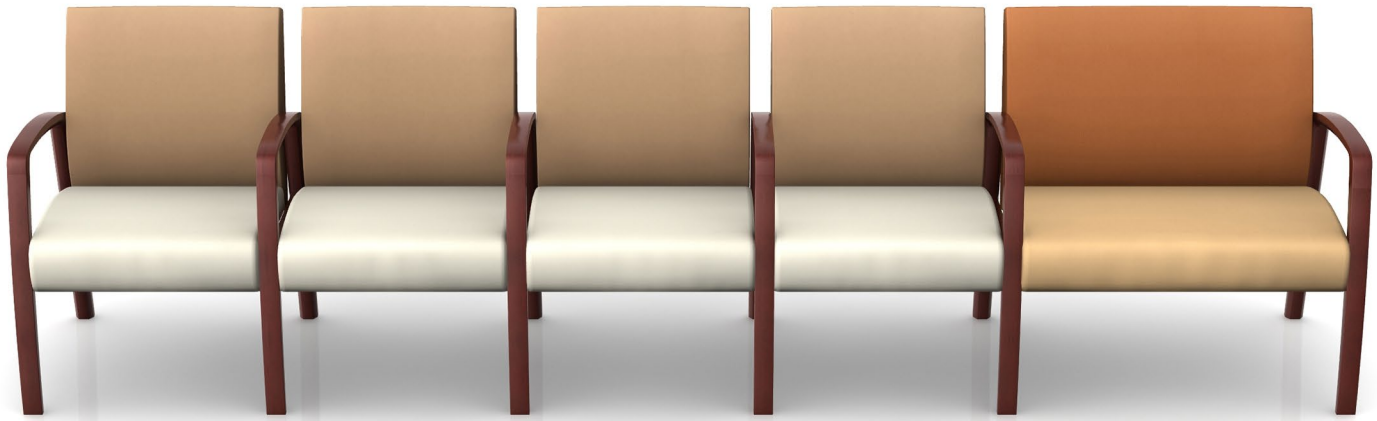

Metal 5-Seat

Aviera

LINKING TABLES

High traffic. Low stress.

Tables are like bridges joining chairs and multi-seating elements. Connect like items together or mix them up. For instance, a table can link to a guest or patient chair on one side and a Preconfigured, freespan, start or end element on the other. In a start/center/end configuration, a table must connect to either a start or an end. End tables have two legs and 90° radius and square tables have one leg.



Wood Center Linking Table

Featured Models

WOOD CENTER LINKING TABLE :: \$590

Center linking table, maple, wood leg, maple wood veneer top and edge

METAL LEG SQUARE CORNER TABLE :: \$745

Square 90-degree corner table, metal leg, laminate top, polymer edge finish



SOLID SURFACE END TABLE :: \$1,145

End table, maple, metal leg and base, solid surface top and edge

Features

- Connects to Aviera Guest, Patient, and Multiseating options
- Four wood finishes and nine laminate colors
- Veener and solid surface top options

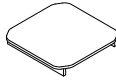
1. Appearance

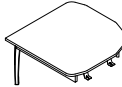
Table Type	Code	Price	
Center	VRL TTL1	\$590	
End	VRL TTL3	\$750	
Round 90-Degree Corner	VRL TTL4	\$775	
Square 90-Degree Corner	VRL TTL5	\$875	

2. Leg and Base

Leg and Base Material	Code	Price	
Wood	LM1	+ \$0	
Metal	LM2	+ \$0	
Leg and Base Finish	Code	Price	
Wood Finish			
Clear Maple	FCW1	+ \$0	
Medium Cherry	FCW2	+ \$0	
Amber Mahogany	FCW3	+ \$0	
Espresso	FCW4	+ \$0	
Stain-to-Match	STM	+ \$70	
New Custom Stain	STL	+ \$275	

New Custom Stain (STL): If stain is not in our library, add this one-time \$275 net fee in addition to the \$70 stain-to-match (STM) cost.

LINKING TABLES

2. Leg and Base (Cont.)

Leg and Base Finish	Code	Price	
Metal Finish			
Silver Metallic	FCM1	+ \$0	
Graphite	FCM2	+ \$0	
Taupe	FCM3	+ \$0	
Leg Options	Code	Price	
Protective Guard Clear Tape (Round or Square Table Type)	LX1	+ \$21	
Protective Guard Clear Tape (End Table Type)	LX1	+ \$42	

3. Tabletop

Tabletop and Edge Material	Code	Price	
Wood and Laminate			
Laminate Top With Polymer Edge	TM3	- \$130	
Beech Wood Veneer Top and Edge	TM2	- \$60	
Maple Wood Veneer Top and Edge	TM1	+ \$0	
Solid Surface			
Center or End Table	TM4	+ \$395	
Corner Table	TM4	+ \$640	
Tabletop Finish	Code	Price	
Laminate Color			
Fusion Maple Laminate	TL1	+ \$0	
Huntington Maple Laminate	TL2	+ \$0	
Cafelle Laminate	TL4	+ \$0	
Shaker Cherry Laminate	TL5	+ \$0	
Fonthill Pear Laminate	TL6	+ \$0	
Brighton Walnut Laminate	TL7	+ \$0	
Khaki Brown Laminate	TL9	+ \$0	
Slate Laminate	TL10	+ \$0	
Black Laminate	TL12	+ \$0	
Laminate-to-Match (10+ Units)	LMM	+ \$0	
Laminate-to-Match (Under 10 Units)	LMM	+ \$300	

3. Tabletop (Cont.)

Tabletop Finish	Code	Price	
Wood Finish			
Clear Maple	FCW1	+ \$0	
Medium Cherry	FCW2	+ \$0	
Amber Mahogany	FCW3	+ \$0	
Espresso	FCW4	+ \$0	
Stain-to-Match	STM	+ \$70	
New Custom Stain	STL	+ \$275	
Solid Surface Finish			
Designer White	Tss2	+ \$0	
Table Edge Finish	Code	Price	
Polymer Finish			
Fusion Maple Polymer	TP1	+ \$0	
Huntington Maple Polymer	TP2	+ \$0	
Cafelle Polymer	TP4	+ \$0	
Mocha Polymer	TP5	+ \$0	
Fonthill Pear Polymer	TP6	+ \$0	
Brighton Walnut Polymer	TP7	+ \$0	
Khaki Brown Polymer	TP9	+ \$0	
Slate Polymer	TP10	+ \$0	
Black Polymer	TP12	+ \$0	
Polymer-to-Match	PTM	+ \$0	

New Custom Stain (STL): If stain is not in our library, add this one-time \$275 net fee in addition to the \$70 stain-to-match (STM) cost.

If laminate top is selected, wood finish will still need to be selected in addition to laminate color. Wood finish is applied to visible understructure.

Polymer finish pairs with laminate top (TM3) only.

LINKING TABLES

4. Packaging

Packaging	Code	Price	
Knocked Down	P7	+ \$0	

SPECIFICATIONS

Model:	VRL TTL3 End	VRL TTL1 Center	VRL TTL4 Round 90° Corner	VRL TTL5 Square 90° Corner
Height (From Floor)	16"	16"	16"	16"
Width	21"	22"	28.4"	31"
Depth	22"	22"	28.4"	31"
Weight (Complete Assembly)	11 lb	11 lb	18 lb	18 lb
Weight (Tabletop)	6.5 lb	6.5 lb	15 lb	15 lb



Solid Surface End Table

Cameo

SEATING AND BENCHES

Design with distinction.

Tap into timeless beauty with a new take on an old classic. Cameo™ dares to move past tufted, boxy and overly square designs—both in shape and attitude. This inspired collection from world-renowned architect and designer Claudio Bellini balances perfect proportions of slenderness with just enough contouring so that it feels as good as it looks.



Featured Models

BENCH :: \$1,465

Cameo single seat bench, chrome base finish, grade 1 textile

ARMLESS SEAT :: \$1,650

Cameo single seat lounge with no arms, charcoal base finish, grade 1 textile





SEAT :: \$1,875

Cameo single seat with dual arms and grade 1 textile

Features

- Add a lightweight, modern look with slim ribbon leg design
- Promotes all-around comfort with contoured seat, back and arms
- Choose between single seat, 2-seater, and 3-seater seats and benches
- Design for traditional and modular configurations
- Create single-arm, dual-arm and armless configurations
- Charcoal, bronze or chrome sled-leg bases
- Designed by Claudio Bellini
- Weight capacity warranty: 400 lb for single-seater; 800 lb for 2- and 3-seater

1. Product

Model	Code	Price	
Single Seat			
Single Seat With Dual Arms	CAM SN1 FS8	\$1,875	
Single Seat With Right Arm	CAM SN1 FS10	\$1,763	
Single Seat With Left Arm	CAM SN1 FS12	\$1,763	
Single Seat Armless	CAM SN1 FS17	\$1,650	
Single Seat Bench	CAM SN1 FS2	\$1,219	

SEATING AND BENCHES

1. Product (Cont.)

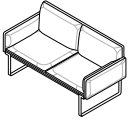
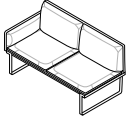
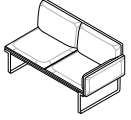
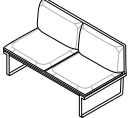
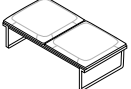
Model	Code	Price	
2-Seater			
2-Seater With Dual Arms	CAM SN2 FS8	\$2,813	
2-Seater With Right Arm	CAM SN2 FS10	\$2,700	
2-Seater With Left Arm	CAM SN2 FS12	\$2,700	
2-Seater Armless	CAM SN2 FS17	\$2,588	
2-Seater Bench	CAM SN2 FS2	\$1,594	

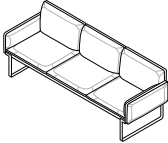
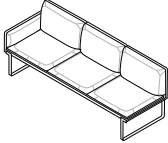
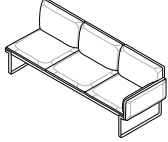
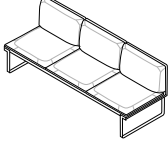
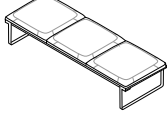
Model	Code	Price	
3-Seater			
3-Seater With Dual Arms	CAM SN3 FS8	\$3,609	
3-Seater With Right Arm	CAM SN3 FS10	\$3,497	
3-Seater With Left Arm	CAM SN3 FS12	\$3,497	
3-Seater Armless	CAM SN3 FS17	\$3,384	
3-Seater Bench	CAM SN3 FS2	\$2,391	

2. Base

Metal Finish	Code	Price
Charcoal	BF04	+ \$0
Bronze	BF05	+ \$0
Chrome	BF06	+ \$250

3. Material

Protection	Code	Price		
Seats		1 Seat	2 Seats	3 Seats
CAL 133	UCAL	+ \$262	+ \$377	+ \$494
Benches		1 Seat	2 Seats	3 Seats
CAL 133	UCAL	+ \$262	+ \$377	+ \$494
Cleaning	Code	Price		
Seats		1 Seat	2 Seats	3 Seats
Moisture Barrier Back	UM1	+ \$59	+ \$118	+ \$177
Moisture Barrier Seat	UM2	+ \$59	+ \$118	+ \$177
Moisture Barrier Back and Seat	UM3	+ \$118	+ \$236	+ \$354
Benches		1 Seat	2 Seats	3 Seats
Moisture Barrier Seat	UM2	+ \$59	+ \$118	+ \$177
Fully Upholstered	Code	Price		
Seat, Dual Arms		1 Seat	2 Seats	3 Seats
COM	COM	+ \$0	+ \$0	+ \$0
Fabric/Vinyl Grade 1	FG1/VG1	+ \$0	+ \$0	+ \$0
Fabric/Vinyl Grade 2	FG2/VG2	+ \$143	+ \$224	+ \$283
Fabric/Vinyl Grade 3	FG3/VG3	+ \$222	+ \$348	+ \$441
Fabric/Vinyl Grade 4	FG4/VG4	+ \$318	+ \$498	+ \$630
Fabric/Vinyl Grade 5	FG5/VG5	+ \$477	+ \$747	+ \$945
Fabric/Vinyl Grade 6	FG6/VG6	+ \$636	+ \$996	+ \$1,260
Fabric/Vinyl Grade 7	FG7/VG7	+ \$795	+ \$1,245	+ \$1,575
COL	COL	+ \$1,575	+ \$2,475	+ \$2,850
Leather Grade 1	LG1	+ \$1,575	+ \$2,475	+ \$2,850
Leather Grade 2	LG2	+ \$1,995	+ \$3,135	+ \$3,610
Leather Grade 3	LG3	+ \$2,520	+ \$3,960	+ \$4,560

3. Material (Cont.)

Fully Upholstered (Cont.)	Code	Price		
Seat, Single Arm		1 Seat	2 Seats	3 Seats
COM	COM	+ \$0	+ \$0	+ \$0
Fabric/Vinyl Grade 1	FG1/VG1	+ \$0	+ \$0	+ \$0
Fabric/Vinyl Grade 2	FG2/VG2	+ \$108	+ \$189	+ \$243
Fabric/Vinyl Grade 3	FG3/VG3	+ \$168	+ \$294	+ \$378
Fabric/Vinyl Grade 4	FG4/VG4	+ \$240	+ \$420	+ \$540
Fabric/Vinyl Grade 5	FG5/VG5	+ \$360	+ \$630	+ \$810
Fabric/Vinyl Grade 6	FG6/VG6	+ \$480	+ \$840	+ \$1,080
Fabric/Vinyl Grade 7	FG7/VG7	+ \$600	+ \$1,050	+ \$1,350
COL	COL	+ \$1,200	+ \$2,175	+ \$2,625
Leather Grade 1	LG1	+ \$1,200	+ \$2,175	+ \$2,625
Leather Grade 2	LG2	+ \$1,520	+ \$2,755	+ \$3,325
Leather Grade 3	LG3	+ \$1,920	+ \$3,480	+ \$4,200
Seat, Armless		1 Seat	2 Seats	3 Seats
COM	COM	+ \$0	+ \$0	+ \$0
Fabric/Vinyl Grade 1	FG1/VG1	+ \$0	+ \$0	+ \$0
Fabric/Vinyl Grade 2	FG2/VG2	+ \$81	\$162	+ \$216
Fabric/Vinyl Grade 3	FG3/VG3	+ \$126	\$252	+ \$336
Fabric/Vinyl Grade 4	FG4/VG4	+ \$180	\$360	+ \$480
Fabric/Vinyl Grade 5	FG5/VG5	+ \$270	\$540	+ \$720
Fabric/Vinyl Grade 6	FG6/VG6	+ \$360	\$720	+ \$960
Fabric/Vinyl Grade 7	FG7/VG7	+ \$450	\$900	+ \$1,200
COL	COL	+ \$900	\$1,875	+ \$2,400
Leather Grade 1	LG1	+ \$900	\$1,875	+ \$2,400
Leather Grade 2	LG2	+ \$1,140	\$2,375	+ \$3,040
Leather Grade 3	LG3	+ \$1,440	\$3,000	+ \$3,840
Bench		1 Seat	2 Seats	3 Seats
COM	COM	+ \$0	+ \$0	+ \$0
Fabric/Vinyl Grade 1	FG1/VG1	+ \$0	+ \$0	+ \$0
Fabric/Vinyl Grade 2	FG2/VG2	+ \$43	+ \$86	+ \$108
Fabric/Vinyl Grade 3	FG3/VG3	+ \$67	+ \$134	+ \$168
Fabric/Vinyl Grade 4	FG4/VG4	+ \$96	+ \$192	+ \$240
Fabric/Vinyl Grade 5	FG5/VG5	+ \$144	+ \$288	+ \$360
Fabric/Vinyl Grade 6	FG6/VG6	+ \$192	+ \$384	+ \$480
Fabric/Vinyl Grade 7	FG7/VG7	+ \$240	+ \$480	+ \$600
COL	COL	+ \$525	+ \$1,050	+ \$1,260
Leather Grade 1	LG1	+ \$525	+ \$1,050	+ \$1,260
Leather Grade 2	LG2	+ \$665	+ \$1,330	+ \$1,596
Leather Grade 3	LG3	+ \$840	+ \$1,680	+ \$2,016

3. Material (Cont.)

Multi-Upholstery	Code	Price		
		1 Seat	2 Seats	3 Seats
Multi-Upholstery Upcharge	UMU	+ \$75	+ \$75	+ \$75
Upholstered Seat Only		1 Seat	2 Seats	3 Seats
COM	COM	+ \$0	+ \$0	+ \$0
Fabric/Vinyl Grade 1	FG1/VG1	+ \$0	+ \$0	+ \$0
Fabric/Vinyl Grade 2	FG2/VG2	+ \$46	+ \$92	+ \$108
Fabric/Vinyl Grade 3	FG3/VG3	+ \$71	+ \$143	+ \$168
Fabric/Vinyl Grade 4	FG4/VG4	+ \$102	+ \$204	+ \$240
Fabric/Vinyl Grade 5	FG5/VG5	+ \$153	+ \$306	+ \$360
Fabric/Vinyl Grade 6	FG6/VG6	+ \$204	+ \$408	+ \$480
Fabric/Vinyl Grade 7	FG7/VG7	+ \$255	+ \$510	+ \$600
COL	COL	+ \$525	+ \$1,050	+ \$1,200
COL or Leather Grade 1	LG1	+ \$525	+ \$1,050	+ \$1,200
Leather Grade 2	LG2	+ \$665	+ \$1,330	+ \$1,520
Leather Grade 3	LG3	+ \$840	+ \$1,680	+ \$1,920
Upholstered Back Only		1 Seat	2 Seats	3 Seats
COM	COM	+ \$0	+ \$0	+ \$0
Fabric/Vinyl Grade 1	FG1/VG1	+ \$0	+ \$0	+ \$0
Fabric/Vinyl Grade 2	FG2/VG2	+ \$38	+ \$76	+ \$101
Fabric/Vinyl Grade 3	FG3/VG3	+ \$59	+ \$118	+ \$157
Fabric/Vinyl Grade 4	FG4/VG4	+ \$84	+ \$168	+ \$225
Fabric/Vinyl Grade 5	FG5/VG5	+ \$126	+ \$252	+ \$337
Fabric/Vinyl Grade 6	FG6/VG6	+ \$168	+ \$336	+ \$450
Fabric/Vinyl Grade 7	FG7/VG7	+ \$210	+ \$420	+ \$562
COL	COL	+ \$420	+ \$840	+ \$1,125
Leather Grade 1	LG1	+ \$420	+ \$840	+ \$1,125
Leather Grade 2	LG2	+ \$532	+ \$1,064	+ \$1,425
Leather Grade 3	LG3	+ \$672	+ \$1,344	+ \$1,800
Upholstered Single Arm Only		1 Seat	2 Seats	3 Seats
COM	COM	+ \$0	+ \$0	+ \$0
Fabric/Vinyl Grade 1	FG1/VG1	+ \$0	+ \$0	+ \$0
Fabric/Vinyl Grade 2	FG2/VG2	+ \$27	+ \$27	+ \$27
Fabric/Vinyl Grade 3	FG3/VG3	+ \$42	+ \$42	+ \$42
Fabric/Vinyl Grade 4	FG4/VG4	+ \$60	+ \$60	+ \$60
Fabric/Vinyl Grade 5	FG5/VG5	+ \$90	+ \$90	+ \$90
Fabric/Vinyl Grade 6	FG6/VG6	+ \$120	+ \$120	+ \$120
Fabric/Vinyl Grade 7	FG7/VG7	+ \$150	+ \$150	+ \$150
COL	COL	+ \$300	+ \$300	+ \$300
Leather Grade 1	LG1	+ \$300	+ \$300	+ \$300
Leather Grade 2	LG2	+ \$380	+ \$380	+ \$380
Leather Grade 3	LG3	+ \$480	+ \$480	+ \$480

3. Material (Cont.)

Multi-Upholstery	Code	Price		
		1 Seat	2 Seats	3 Seats
Upholstered Dual Arms Only		1 Seat	2 Seats	3 Seats
COM	COM	+ \$0	+ \$0	+ \$0
Fabric/Vinyl Grade 1	FG1/VG1	+ \$0	+ \$0	+ \$0
Fabric/Vinyl Grade 2	FG2/VG2	+ \$54	+ \$54	+ \$54
Fabric/Vinyl Grade 3	FG3/VG3	+ \$84	+ \$84	+ \$84
Fabric/Vinyl Grade 4	FG4/VG4	+ \$120	+ \$120	+ \$120
Fabric/Vinyl Grade 5	FG5/VG5	+ \$180	+ \$180	+ \$180
Fabric/Vinyl Grade 6	FG6/VG6	+ \$240	+ \$240	+ \$240
Fabric/Vinyl Grade 7	FG7/VG7	+ \$300	+ \$300	+ \$300
COL	LG1	+ \$600	+ \$600	+ \$600
Leather Grade 1	LG1	+ \$600	+ \$600	+ \$600
Leather Grade 2	LG2	+ \$760	+ \$760	+ \$760
Leather Grade 3	LG3	+ \$960	+ \$960	+ \$960

If different fabrics are selected for the seat and back, add the multiple upholstery upcharge (UMU) as well, even if the two fabrics are the same grade.

Please reference the Textile Reference Guide for pricing on fabric over grade 7 and leather over grade 3.

4. Miscellaneous

Accessories	Code	Price
Ganging Bracket	CAM XGV	+ \$52

One set of gangers (2 brackets) is included in this kit and can be installed on the left or right side of a seat or bench.

These two brackets are enough to gang two upholstered units together (benches or lounge units with or without an arm on the ganged side).

The inline table (CAMT TTL1) and the corner table (CAMT TTL4) are shipped standard with a total of two sets of gangers (4 brackets) to be supported between two upholstered units.

Order multiple quantities if ganging more than two pieces together.

Note: Ganging brackets are field installed.

5. Packaging

Packaging	Code	Price
Partially Assembled in Carton	P3	+ \$0

Leg ships unattached.

SEATING AND BENCHES

SPECIFICATIONS: SEATS WITH DUAL ARMS

Model:	CAM SN1 FS8 Single-Seat	CAM SN2 FS8 2-Seater	CAM SN3 FS8 3-Seater
Height	30"	30"	30"
Width	32.75"	60"	86.6"
Depth	28"	28"	28"
Seat Depth	20.25"	20.25"	20.25"
Seat Height	16.75"	16.75"	16.75"
Back Height	13.25"	13.25"	13.25"
Weight	75 lb	116 lb	169 lb
COM (Single Upholstery)	5 yd	7.5 yd	10.5 yd
COM (Multi-Upholstery)			
Seat	1.75 yd	3.25 yd	5 yd
Back	1.6 yd	3 yd	4.75 yd
Arms	2.25 yd	2.25 yd	2.25 yd
COL (Single Upholstery)	99 sq ft	147 sq ft	170 sq ft
COL (Multi-Upholstery)			
Seat	31 sq ft	63 sq ft	80 sq ft
Back	31 sq ft	57 sq ft	75 sq ft
Arms	42 sq ft	42 sq ft	42 sq ft
Weight Capacity Warranty	400 lb	800 lb	800 lb

SPECIFICATIONS: SEATS WITH SINGLE ARM

Model:	CAM SN1 FS10 CAM SN1 FS12 Single Seat	CAM SN2 FS10 CAM SN2 FS12 2-Seater	CAM SN3 FS10 CAM SN3 FS12 3-Seater
Height	30"	30"	30"
Width	30"	57"	84"
Depth	28"	28"	28"
Seat Depth	20.25"	20.25"	20.25"
Seat Height	16.75"	16.75"	16.75"
Back Height	13.25"	13.25"	13.25"
Weight	65 lb	105 lb	159 lb
COM (Fully Upholstered)	4 yd	6.5 yd	9 yd
COM (Multi-Upholstery)			
Seat	1.75 yd	3.25 yd	5 yd
Back	1.6 yd	3 yd	4.75 yd
Arms	1.25 yd	1.25 yd	1.25 yd
COL (Fully Upholstered)	78 sq ft	126 sq ft	150 sq ft
COL (Multi-Upholstery)			
Seat	31 sq ft	63 sq ft	80 sq ft
Back	31 sq ft	57 sq ft	75 sq ft
Arms	26 sq ft	26 sq ft	26 sq ft
Weight Capacity Warranty	400 lb	800 lb	800 lb

SPECIFICATIONS: ARMLESS SEATS

Model:	CAM SN1 FS17 Single-Seat	CAM SN2 FS17 2-Seater	CAM SN3 FS17 3-Seater
Height	30"	30"	30"
Width	27.5"	54.5"	81.5"
Depth	28"	28"	28"
Seat Depth	20.25"	20.25"	20.25"
Seat Height	16.75"	16.75"	16.75"
Back Height	13.25"	13.25"	13.25"
Weight	54 lb	95 lb	148 lb
COM (Fully Upholstered)	3.25 yd	5.75 yd	8 yd
COM (Multi-Upholstery)			
Seat	1.75 yd	3.25 yd	5 yd
Back	1.6 yd	3 yd	4.75 yd
COL (Fully Upholstered)	63 sq ft	115 sq ft	130 sq ft
COL (Multi-Upholstery)			
Seat	31 sq ft	63 sq ft	80 sq ft
Back	31 sq ft	57 sq ft	75 sq ft
Weight Capacity Warranty	400 lb	800 lb	800 lb

SPECIFICATIONS: BENCHES

Model:	CAM SN1 FS2 Single Seat	CAM SN2 FS2 2-Seater	CAM SN3 FS2 3-Seater
Height	16.75"	16.75"	16.75"
Width	27.5"	54.5"	81.5"
Depth	28"	28"	28"
Seat Depth	28"	28"	28"
Seat Height	16.75"	16.75"	16.75"
Weight	35 lb	56 lb	78 lb
COM (Fully Upholstered)	2 yd	3.75 yd	5 yd
COL (Fully Upholstered)	36 sq ft	68 sq ft	84 sq ft
Weight Capacity Warranty	400 lb	800 lb	800 lb



Cameo

INLINE AND COFFEE TABLES

Design with distinction.

Too many contemporary collections promise adaptable configurations but fall short. Cameo includes a wide variety of seats, benches and tables—for traditional and modular configurations that fit any space. Something truly mod-mod (at last).



Inline Table (Seats not Included)

Featured Models

INLINE TABLE :: \$1,000

Cameo inline table, laminate table top, chrome base finish

CORNER TABLE :: \$1,000

Cameo corner table, laminate table top, bronze base finish

COFFEE TABLE :: \$1,866

Cameo rectangular coffee table, laminate table top, charcoal base finish

1. Product

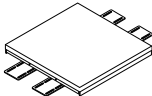
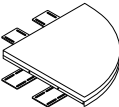
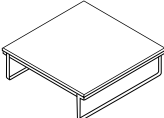
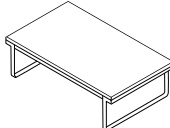
Model	Code	Price	
Inline Table	CAMT TTL1	\$750	
Corner Table	CAMT TTL4	\$1000	
Square Coffee Table	CAMT TT8	\$1,350	
Rectangular Coffee Table	CAMT TT9	\$1,866	

The inline table (CAMT TTL1) and the corner table (CAMT TTL4) are shipped standard with a total of two sets of gangers (4 brackets) to be supported between two upholstered units.

2. Tabletop

Material	Code	Price	
Laminate	TM3	+ \$0	
Laminate Finish	Code	Price	
Field Elm	TL13	+ \$0	
Uptown Walnut	TL14	+ \$0	
Skyline Walnut	TL15	+ \$0	
Frosty White	TL16	+ \$0	
Classic Linen	TL17	+ \$0	

INLINE AND COFFEE TABLES

3. Table Base

Metal Finish	Code	Price	
Charcoal	BF04	+ \$0	
Bronze	BF05	+ \$0	
Chrome	BF06	+ \$250	

Finish also applies to the edge band.

4. Packaging

Packaging	Code	Price	
Partially Assembled in Carton	P3	+ \$0	

SPECIFICATIONS: LINKING TABLES

Model:	Inline Table	Corner Table
Width	27"	39.5"
Depth	28"	28.3"
Height	14.5"	14.5"
Weight	47 lb	44 lb

SPECIFICATIONS: COFFEE TABLES

Model:	Square Coffee Table	Rectangular Coffee Table
Width	47.25"	47.3"
Depth	47.25"	27.8"
Height	14.5"	14.5"
Weight	120 lb	72 lb



Rectangular Coffee Table

Composium

CURVE CLUB CHAIR, SETTEE AND SOFA

Perfect harmony.

Transitional styling that blends well with collaboration areas and group housing defines Composium® Curve. This robust lounge seating collection offers three back styles, four valance styles and 11 foot styles to make it a comfortable seating choice for industrial, formal higher education or assisted living settings. Composium is rugged and easy to maintain with field-replaceable parts and durable steel-rail construction that withstands tough environments. Our PatternMatch® expertise ensures that every chair is a perfect match. Add an optional tablet arm or arm cap to create truly unique seating—just like you imagined.



Club Chair With Wood Tapered Feet

Featured Models

CLUB CHAIR WITH PLASTIC FEET :: \$1,685

Composium Curve club chair, square back, arched valance, black plastic feet, fully upholstered, grade 1 textile

CLUB CHAIR WITH WOOD TAPERED FEET :: \$1,825

Composium Curve club chair, square back, full valance, wood tapered square feet, fully upholstered, grade 1 textile

SETTEE WITH WOOD SIDE RAILS :: \$2,638

Composium Curve settee, square back, integrated valance, wood tapered square feet with side rails, fully upholstered, grade 3 textile

Features

- Club, settee and sofa sizes
- PatternMatch® expertise and multi-upholstery options
- Durable steel-rail construction
- Three back types — square, round and scalloped
- Four valance styles — full, integrated, three-quarter and arched
- 11 foot styles including casters, metal pole and wood
- Optional clean-out space
- Sustainable manufacturing and Take Back Program
- 300 lb weight capacity warranty per seat
- Optional power module available

1. Product

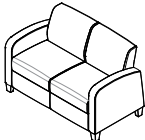
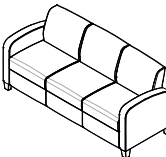
Model and Size	Code	Price	
Club	CP AS3 SN1	\$1,685	
Settee	CP AS3 SN2	\$2,205	
Sofa	CP AS3 SN3	\$2,705	

Order Compositum ottoman and bench seating on page 104.

2. Back

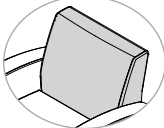
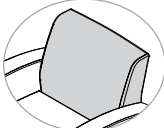
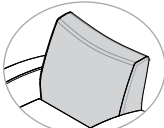
Back Shape	Code	Price	
Square	BS1	+\$0	
Round	BS2	+\$0	
Scalloped	BS3	+\$0	

3. Seat

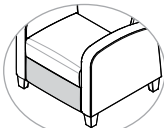
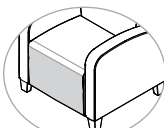
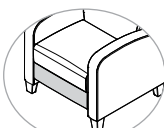
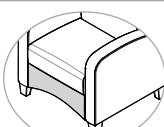
Valance Style	Code	Price	
Full	SV1	+\$0	
Integrated	SV2	+\$0	
Three-Quarter	SV3	+\$0	
Arched	SV4	+\$0	

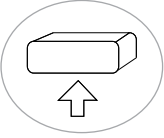
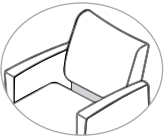

3. Seat (Cont.)

Seat Options	Code	Price	
Removable Cushion			
For Club Chair	SX1	+ \$59	
For Settee	SX1	+ \$118	
For Sofa	SX1	+ \$177	
Clean-Out			
For Club Chair	SX2	+ \$0	
For Settee	SX2	+ \$0	
For Sofa	SX2	+ \$0	

Removable cushion not available with clean-out or integrated valance.

CURVE CLUB CHAIR, SETTEE AND SOFA

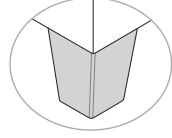
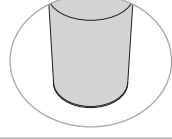
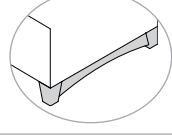
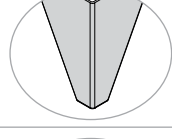
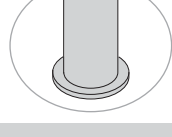
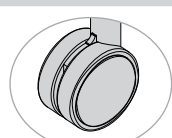
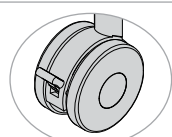
4. Foot

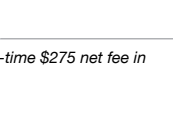
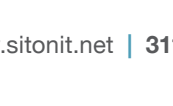
Foot Style and Color	Code	Price	
Feet			
Standard Plastic, Black	LS1	+ \$0	
Wood Tapered Square	LS12	+ \$140	
Wood Tapered Cylinder	LS11	+ \$140	
Wood Tapered Square With Side Rails	LS13	+ \$200	
Metal Angular, Brushed Aluminum	LS6	+ \$120	
Metal 1.5" Pole, Brushed Aluminum	LS7	+ \$120	
Metal 1.5" Pole, Silver Powder Coat	LS8	+ \$120	
Casters			
Non-Locking Caster, Black	LS2	+ \$100	
Non-Locking Caster, Silver	LS3	+ \$100	
Locking Caster, Black	LS4	+ \$120	
Locking Caster, Silver	LS5	+ \$120	

5. Frame (For Wooden Feet LS11/LS12/LS13)

Frame Finish Color	Code	Price	
Clear Maple	FCW1	+ \$0	
Medium Cherry	FCW2	+ \$0	
Amber Mahogany	FCW3	+ \$0	
Espresso	FCW4	+ \$0	
Stain-to-Match	STM	+ \$70	
New Custom Stain	STL	+ \$275	

New Custom Stain (STL): If stain is not in our library, add this one-time \$275 net fee in addition to the \$70 stain-to-match (STM) cost.



Club Chair With Plastic Feet

6. Power

Power Location	Code	Price
Right Hand, Front of Unit	PFR	+ \$250
Left Hand, Front of Unit	PFL	+ \$250
Both Hands, Front of Unit	PFB	+ \$500

Power Color	Code	Price
Silver	PC2	+ \$0
Black	PC1	+ \$0

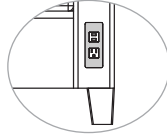
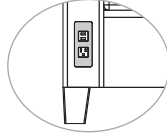

Power located on both hands (PFB) not available with club chair models (SN1).

7. Material

Protection	Code	Price		
CAL 133		Club	Settee	Sofa
CAL 133	UCAL	+ \$262	+ \$377	+ \$494

Cleaning	Code	Price		
Moisture Barrier		Club	Settee	Sofa
Moisture Barrier Seat	UM2	+ \$59	+ \$118	+ \$177
Moisture Barrier Back	UM1	+ \$59	+ \$118	+ \$177
Moisture Barrier Seat and Back	UM3	+ \$118	+ \$236	+ \$354

Fully Upholstered	Code	Price		
Seat, Back, Arm and Valance Upholstery		Club	Settee	Sofa
COM	COM	+ \$0	+ \$0	+ \$0
Fabric/Vinyl Grade 1	FG1/VG1	+ \$0	+ \$0	+ \$0
Fabric/Vinyl Grade 2	FG2/VG2	+ \$53	+ \$78	+ \$100
Fabric/Vinyl Grade 3	FG3/VG3	+ \$158	+ \$233	+ \$300
Fabric/Vinyl Grade 4	FG4/VG4	+ \$263	+ \$388	+ \$500
Fabric/Vinyl Grade 5	FG5/VG5	+ \$394	+ \$582	+ \$750
Fabric/Vinyl Grade 6	FG6/VG6	+ \$578	+ \$853	+ \$1,100
Fabric/Vinyl Grade 7	FG7/VG7	+ \$814	+ \$1,202	+ \$1,550
COL	COL	+ \$834	+ \$1,230	+ \$1,592
Leather Grade 1	LG1	+ \$834	+ \$1,230	+ \$1,592
Leather Grade 2	LG2	+ \$1,095	+ \$1,614	+ \$2,089
Leather Grade 3	LG3	+ \$1,512	+ \$2,229	+ \$2,885

CURVE CLUB CHAIR, SETTEE AND SOFA

7. Material (Cont.)

Multi-Upholstery	Code	Price		
		Club	Settee	Sofa
Multi-Upholstery Upcharge	UMU	+ \$113	+ \$113	+ \$113

Seat Textile Only		Club	Settee	Sofa
COM	COM	+ \$0	+ \$0	+ \$0
Fabric/Vinyl Grade 1	FG1/VG1	+ \$0	+ \$0	+ \$0
Fabric/Vinyl Grade 2	FG2/VG2	+ \$8	+ \$14	+ \$20
Fabric/Vinyl Grade 3	FG3/VG3	+ \$23	+ \$42	+ \$60
Fabric/Vinyl Grade 4	FG4/VG4	+ \$39	+ \$70	+ \$100
Fabric/Vinyl Grade 5	FG5/VG5	+ \$58	+ \$105	+ \$150
Fabric/Vinyl Grade 6	FG6/VG6	+ \$84	+ \$153	+ \$220
Fabric/Vinyl Grade 7	FG7/VG7	+ \$119	+ \$215	+ \$310
COL	COL	+ \$122	+ \$221	+ \$319
Leather Grade 1	LG1	+ \$122	+ \$221	+ \$319
Leather Grade 2	LG2	+ \$159	+ \$289	+ \$418
Leather Grade 3	LG3	+ \$220	+ \$399	+ \$577

Back Textile Only		Club	Settee	Sofa
COM	COM	+ \$0	+ \$0	+ \$0
Fabric/Vinyl Grade 1	FG1/VG1	+ \$0	+ \$0	+ \$0
Fabric/Vinyl Grade 2	FG2/VG2	+ \$15	+ \$28	+ \$40
Fabric/Vinyl Grade 3	FG3/VG3	+ \$44	+ \$84	+ \$118
Fabric/Vinyl Grade 4	FG4/VG4	+ \$72	+ \$139	+ \$197
Fabric/Vinyl Grade 5	FG5/VG5	+ \$108	+ \$209	+ \$295
Fabric/Vinyl Grade 6	FG6/VG6	+ \$159	+ \$306	+ \$432
Fabric/Vinyl Grade 7	FG7/VG7	+ \$224	+ \$430	+ \$609
COL	COL	+ \$229	+ \$441	+ \$625
Leather Grade 1	LG1	+ \$229	+ \$441	+ \$625
Leather Grade 2	LG2	+ \$301	+ \$578	+ \$820
Leather Grade 3	LG3	+ \$415	+ \$798	+ \$1,132

Arms Textile Only		Club	Settee	Sofa
COM	COM	+ \$0	+ \$0	+ \$0
Fabric/Vinyl Grade 1	FG1/VG1	+ \$0	+ \$0	+ \$0
Fabric/Vinyl Grade 2	FG2/VG2	+ \$23	+ \$23	+ \$21
Fabric/Vinyl Grade 3	FG3/VG3	+ \$69	+ \$67	+ \$63
Fabric/Vinyl Grade 4	FG4/VG4	+ \$115	+ \$111	+ \$104
Fabric/Vinyl Grade 5	FG5/VG5	+ \$172	+ \$166	+ \$156
Fabric/Vinyl Grade 6	FG6/VG6	+ \$252	+ \$243	+ \$229
Fabric/Vinyl Grade 7	FG7/VG7	+ \$355	+ \$342	+ \$322
COL	COL	+ \$364	+ \$350	+ \$331
Leather Grade 1	LG1	+ \$364	+ \$350	+ \$331
Leather Grade 2	LG2	+ \$477	+ \$459	+ \$434
Leather Grade 3	LG3	+ \$659	+ \$634	+ \$600

7. Material (Cont.)

Multi-Upholstery (Cont.)	Code	Price		
		Club	Settee	Sofa
Valance Textile Only				
COM	COM	+ \$0	+ \$0	+ \$0
Fabric/Vinyl Grade 1	FG1/VG1	+ \$0	+ \$0	+ \$0
Fabric/Vinyl Grade 2	FG2/VG2	+ \$8	+ \$14	+ \$20
Fabric/Vinyl Grade 3	FG3/VG3	+ \$23	+ \$42	+ \$60
Fabric/Vinyl Grade 4	FG4/VG4	+ \$39	+ \$70	+ \$100
Fabric/Vinyl Grade 5	FG5/VG5	+ \$58	+ \$105	+ \$150
Fabric/Vinyl Grade 6	FG6/VG6	+ \$84	+ \$153	+ \$220
Fabric/Vinyl Grade 7	FG7/VG7	+ \$119	+ \$215	+ \$310
COL	COL	+ \$122	+ \$221	+ \$319
Leather Grade 1	LG1	+ \$122	+ \$221	+ \$319
Leather Grade 2	LG2	+ \$159	+ \$289	+ \$418
Leather Grade 3	LG3	+ \$220	+ \$399	+ \$577

If different fabrics are selected for the seat, back, arms and/or valance add the multiple upholstery upcharge (IMU) as well, even if the two fabrics are the same grade.

Please reference the Textile Reference Guide for pricing on fabric over grade 7 and leather over grade 3.

8. Packaging

Packaging	Code	Price
Fully Assembled in a Carton	P1	+ \$0

SPECIFICATIONS

Model:	Club CP AS3 SN1	Settee CP AS3 SN2	Sofa CP AS3 SN3
Height	34"	34"	34"
Width	31"	53"	75"
Depth	28"	28"	28"
Seat Width	22"	44"	66"
Seat Depth	19.5"	19.5"	19.5"
Seat Height	19.5"	19.5"	19.5"
Back Height	16"	16"	16"
Arm Height	26"	26"	26"
Weight	70 lb	115 lb	160 lb
COM (Fully Upholstered)	5.3 yd	7.9 yd	10.5 yd
COM (Multi-Upholstery)			
Seat Only	1.9 yd	3.2 yd	3.8 yd
Back Only	2.2 yd	4.1 yd	5.8 yd
Arms Only	3.8 yd	3.8 yd	3.8 yd
Valance Only	1 yd	1.3 yd	1.3 yd
COL (Fully Upholstered)	83.3 sq ft	122.5 sq ft	163.7 sq ft
COL (Multi-Upholstery)			
Seat Only	29.4 sq ft	49 sq ft	58.8 sq ft
Back Only	33.4 sq ft	63.7 sq ft	90.2 sq ft
Arms Only	58.8 sq ft	58.8 sq ft	58.8 sq ft
Valance Only	14.7 sq ft	19.6 sq ft	19.6 sq ft
Weight Capacity Warranty (Per Seat)	300 lb	300 lb	300 lb

Yardage requirements for COM and COL are for solid and non-directional fabrics. Additional material may be required for larger repeating patterns.



Settee With Wood Side Rails

Composium

FLAIR CLUB CHAIR, SETTEE AND SOFA

Perfect harmony.

Composium® Flair delivers contemporary elegance via the retro flair arm style. This robust lounge seating collection offers three back styles, four valance styles and 11 foot styles to make it a comfortable seating choice, from corporate to hospitality to higher education applications. Composium is rugged and easy to maintain with field-replaceable parts and durable steel-rail construction that withstands tough environments. Our PatternMatch® expertise ensures that every chair is a perfect match. Add an optional tablet arm or arm cap to create truly unique seating—just like you imagined.



Club Chair With Metal Pole Feet

Featured Models

CLUB CHAIR WITH METAL POLE FEET :: \$1,853

Composium Flair club chair, scalloped back, full valance, brushed aluminum metal pole feet, fully upholstered, grade 2 vinyl

SETTEE WITH METAL POLE FEET :: \$2,325

Composium Flair settee, square back, three-quarter valance, brushed aluminum metal pole feet, fully upholstered, grade 1 textile



SOFA WITH WOOD FEET AND ARM CAPS :: \$3,467

Composium Flair sofa, square back, arched valance, wood arm caps, wood tapered square feet, fully upholstered, grade 4 textile

Features

- Club, settee and sofa sizes
- PatternMatch™ expertise and multi-upholstery options
- Durable steel-rail construction
- Three back types — square, round and scalloped
- Four valance styles — full, integrated, three-quarter and arched
- 11 foot styles including casters, metal pole and wood
- Optional clean-out space
- Optional wood arm cap and cushion
- Sustainable manufacturing and Take Back Program
- 300 lb weight capacity warranty per seat
- Optional power module available

1. Product

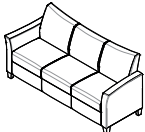
Model and Size	Code	Price	
Club	CP AS2 SN1	\$1,685	
Settee	CP AS2 SN2	\$2,205	
Sofa	CP AS2 SN3	\$2,705	

2. Arms

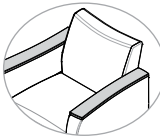
Arm Cap	Code	Price	
Wood Arm Cap	ACP1	+\$147	

FLAIR CLUB CHAIR, SETTEE AND SOFA

3. Back

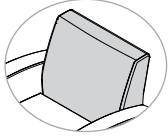
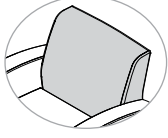
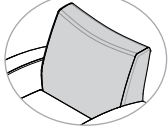
Back Shape	Code	Price	
Square	BS1	+\$0	
Round	BS2	+\$0	
Scalloped	BS3	+\$0	

4. Seat

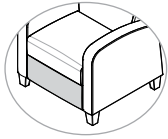
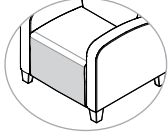
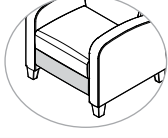
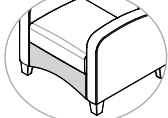
Valance Style	Code	Price	
Full	SV1	+\$0	
Integrated	SV2	+\$0	
Three-Quarter	SV3	+\$0	
Arched	SV4	+\$0	

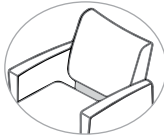

Removable Cushion	Code	Price	
For Club Chair	SX1	+\$59	
For Settee	SX1	+\$118	
For Sofa	SX1	+\$177	

4. Seat (Cont.)

Clean-Out	Code	Price	
For Club Chair	SX2	+ \$0	
For Settee	SX2	+ \$0	
For Sofa	SX2	+ \$0	

Removable cushion not available with clean-out or integrated valance.

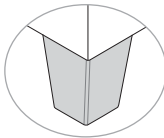
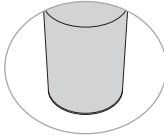
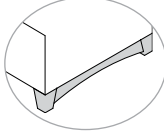
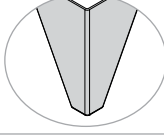
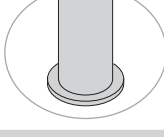
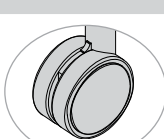
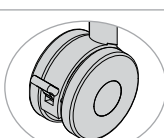
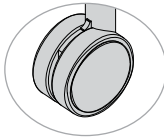
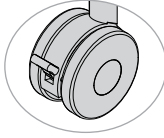
5. Foot

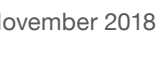
Foot Style and Color	Code	Price	
Feet			
Standard Plastic, Black	LS1	+ \$0	
Wood Tapered Square	LS12	+ \$140	
Wood Tapered Cylinder	LS11	+ \$140	
Wood Tapered Square With Side Rails	LS13	+ \$200	
Metal Angular, Brushed Aluminum	LS6	+ \$120	
Metal 1.5" Pole, Brushed Aluminum	LS7	+ \$120	
Metal 1.5" Pole, Silver Powder Coat	LS8	+ \$120	
Casters			
Non-Locking Caster, Black	LS2	+ \$100	
Non-Locking Caster, Silver	LS3	+ \$100	
Locking Caster, Black	LS4	+ \$120	
Locking Caster, Silver	LS5	+ \$120	

FLAIR CLUB CHAIR, SETTEE AND SOFA

6. Frame (For Wooden Feet LS11/LS12/LS13 or Tablet Arm AX1/AX4)

Frame Finish Color	Code	Price	
Clear Maple	FCW1	+ \$0	
Medium Cherry	FCW2	+ \$0	
Amber Mahogany	FCW3	+ \$0	
Espresso	FCW4	+ \$0	
Stain-to-Match	STM	+ \$70	
New Custom Stain	STL	+ \$275	

New Custom Stain (STL): If stain is not in our library, add this one-time \$275 net fee in addition to the \$70 stain-to-match (STM) cost.

7. Power

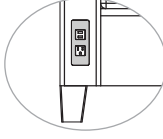
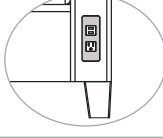
Power Location	Code	Price	
Right Hand, Front of Unit	PFR	+ \$250	
Left Hand, Front of Unit	PFL	+ \$250	
Both Hands, Front of Unit	PFB	+ \$500	
Power Color	Code	Price	
Silver	PC2	+ \$0	
Black	PC1	+ \$0	

Power located on both hands (PFB) not available with club chair models (SN1).

8. Material

Protection	Code	Price		
CAL 133		Club	Settee	Sofa
CAL 133	UCAL	+ \$262	+ \$377	+ \$494
Cleaning	Code	Price		
Moisture Barrier		Club	Settee	Sofa
Moisture Barrier Seat	UM2	+ \$59	+ \$118	+ \$177
Moisture Barrier Back	UM1	+ \$59	+ \$118	+ \$177
Moisture Barrier Seat and Back	UM3	+ \$118	+ \$236	+ \$354

8. Material (Cont.)

Fully Upholstered	Code	Price		
		Club	Settee	Sofa
Seat, Back, Arm and Valance Upholstery				
COM	COM	+ \$0	+ \$0	+ \$0
Fabric/Vinyl Grade 1	FG1/VG1	+ \$0	+ \$0	+ \$0
Fabric/Vinyl Grade 2	FG2/VG2	+ \$48	+ \$73	+ \$95
Fabric/Vinyl Grade 3	FG3/VG3	+ \$143	+ \$218	+ \$285
Fabric/Vinyl Grade 4	FG4/VG4	+ \$238	+ \$363	+ \$475
Fabric/Vinyl Grade 5	FG5/VG5	+ \$357	+ \$544	+ \$713
Fabric/Vinyl Grade 6	FG6/VG6	+ \$523	+ \$798	+ \$1,045
Fabric/Vinyl Grade 7	FG7/VG7	+ \$737	+ \$1,124	+ \$1,473
COL	COL	+ \$758	+ \$1,154	+ \$1,516
Leather Grade 1	LG1	+ \$758	+ \$1,154	+ \$1,516
Leather Grade 2	LG2	+ \$995	+ \$1,515	+ \$1,990
Leather Grade 3	LG3	+ \$1,374	+ \$2,092	+ \$2,748
Multi-Upholstery	Code	Price		
		Club	Settee	Sofa
Multi-Upholstery Upcharge	UMU	+ \$113	+ \$113	+ \$113
Seat Textile Only		Club	Settee	Sofa
COM	COM	+ \$0	+ \$0	+ \$0
Fabric/Vinyl Grade 1	FG1/VG1	+ \$0	+ \$0	+ \$0
Fabric/Vinyl Grade 2	FG2/VG2	+ \$7	+ \$13	+ \$19
Fabric/Vinyl Grade 3	FG3/VG3	+ \$21	+ \$39	+ \$57
Fabric/Vinyl Grade 4	FG4/VG4	+ \$35	+ \$65	+ \$95
Fabric/Vinyl Grade 5	FG5/VG5	+ \$52	+ \$98	+ \$143
Fabric/Vinyl Grade 6	FG6/VG6	+ \$76	+ \$143	+ \$209
Fabric/Vinyl Grade 7	FG7/VG7	+ \$107	+ \$202	+ \$295
COL	COL	+ \$111	+ \$207	+ \$304
Leather Grade 1	LG1	+ \$111	+ \$207	+ \$304
Leather Grade 2	LG2	+ \$145	+ \$271	+ \$398
Leather Grade 3	LG3	+ \$200	+ \$375	+ \$550
Back Textile Only		Club	Settee	Sofa
COM	COM	+ \$0	+ \$0	+ \$0
Fabric/Vinyl Grade 1	FG1/VG1	+ \$0	+ \$0	+ \$0
Fabric/Vinyl Grade 2	FG2/VG2	+ \$14	+ \$26	+ \$38
Fabric/Vinyl Grade 3	FG3/VG3	+ \$40	+ \$78	+ \$112
Fabric/Vinyl Grade 4	FG4/VG4	+ \$66	+ \$130	+ \$187
Fabric/Vinyl Grade 5	FG5/VG5	+ \$98	+ \$195	+ \$280
Fabric/Vinyl Grade 6	FG6/VG6	+ \$144	+ \$286	+ \$410
Fabric/Vinyl Grade 7	FG7/VG7	+ \$202	+ \$403	+ \$578
COL	COL	+ \$208	+ \$413	+ \$595
Leather Grade 1	LG1	+ \$208	+ \$413	+ \$595
Leather Grade 2	LG2	+ \$273	+ \$542	+ \$781
Leather Grade 3	LG3	+ \$377	+ \$749	+ \$1,078

8. Material (Cont.)

Multi-Upholstery	Code	Price		
		Club	Settee	Sofa
Arms Textile Only				
COM	COM	+ \$0	+ \$0	+ \$0
Fabric/Vinyl Grade 1	FG1/VG1	+ \$0	+ \$0	+ \$0
Fabric/Vinyl Grade 2	FG2/VG2	+ \$21	+ \$21	+ \$20
Fabric/Vinyl Grade 3	FG3/VG3	+ \$63	+ \$62	+ \$60
Fabric/Vinyl Grade 4	FG4/VG4	+ \$104	+ \$104	+ \$99
Fabric/Vinyl Grade 5	FG5/VG5	+ \$156	+ \$155	+ \$148
Fabric/Vinyl Grade 6	FG6/VG6	+ \$228	+ \$227	+ \$218
Fabric/Vinyl Grade 7	FG7/VG7	+ \$321	+ \$320	+ \$306
COL	COL	+ \$331	+ \$328	+ \$315
Leather Grade 1	LG1	+ \$331	+ \$328	+ \$315
Leather Grade 2	LG2	+ \$434	+ \$431	+ \$414
Leather Grade 3	LG3	+ \$599	+ \$595	+ \$571
Valance Textile Only		Club	Settee	Sofa
COM	COM	+ \$0	+ \$0	+ \$0
Fabric/Vinyl Grade 1	FG1/VG1	+ \$0	+ \$0	+ \$0
Fabric/Vinyl Grade 2	FG2/VG2	+ \$7	+ \$13	+ \$19
Fabric/Vinyl Grade 3	FG3/VG3	+ \$21	+ \$39	+ \$57
Fabric/Vinyl Grade 4	FG4/VG4	+ \$35	+ \$65	+ \$95
Fabric/Vinyl Grade 5	FG5/VG5	+ \$52	+ \$98	+ \$143
Fabric/Vinyl Grade 6	FG6/VG6	+ \$76	+ \$143	+ \$209
Fabric/Vinyl Grade 7	FG7/VG7	+ \$107	+ \$202	+ \$295
COL	COL	+ \$111	+ \$207	+ \$304
Leather Grade 1	LG1	+ \$111	+ \$207	+ \$304
Leather Grade 2	LG2	+ \$145	+ \$271	+ \$398
Leather Grade 3	LG3	+ \$200	+ \$375	+ \$550

If different fabrics are selected for the seat, back, arms and/or valance add the multiple upholstery upcharge (UMU) as well, even if the two fabrics are the same grade.

Please reference the Textile Reference Guide for pricing on fabric over grade 7 and leather over grade 3.

9. Packaging

Packaging	Code	Price
Fully Assembled in a Carton	P1	+ \$0

GSA SIN #: 33721

SPECIFICATIONS

Model:	Club CP AS2 SN1	Settee CP AS2 SN2	Sofa CP AS2 SN3
Height	34"	34"	34"
Width	33"	55"	77"
Depth	28"	28"	28"
Seat Width	22"	44"	66"
Seat Depth	19.5"	19.5"	19.5"
Seat Height	19.5"	19.5"	19.5"
Back Height	16"	16"	16"
Arm Height	26"	26"	26"
Weight	70 lb	115 lb	160 lb
COM (Fully Upholstered)	5.3 yd	7.9 yd	10.5 yd
COM (Multi-Upholstery)			
Seat Only	1.9 yd	3.2 yd	3.8 yd
Back Only	2.2 yd	4.1 yd	5.8 yd
Arms Only	3.8 yd	3.8 yd	3.8 yd
Valance Only	1 yd	1.3 yd	1.3 yd
COL (Fully Upholstered)	83.3 sq ft	122.5 sq ft	163.7 sq ft
COL (Multi-Upholstery)			
Seat Only	29.4 sq ft	49 sq ft	58.8 sq ft
Back Only	33.4 sq ft	63.7 sq ft	90.2 sq ft
Arms Only	58.8 sq ft	58.8 sq ft	58.8 sq ft
Valance Only	14.7 sq ft	19.6 sq ft	19.6 sq ft
Weight Capacity	300 lb	300 lb	300 lb
Warranty (Per Seat)			

Yardage requirements for COM and COL are for solid and non-directional fabrics. Additional material may be required for larger repeating patterns.



Sofa With Wood Feet and Arm Caps

Composium

SHARP CLUB CHAIR, SETTEE AND SOFA

Perfect harmony.

Composium® Sharp delivers harmonious contemporary style with straight lines and minimalist styling. This robust lounge seating collection offers three back styles, four valance styles and 11 foot styles to make it a comfortable seating choice for industrial, formal or higher education settings. Composium is rugged and easy to maintain with field-replaceable parts and durable steel-rail construction that withstands tough environments. Our PatternMatch® expertise ensures that every chair is a perfect match. Add an optional tablet arm or arm cap to create truly unique seating—just like you imagined.



Club Chair With Plastic Feet

Featured Models

CLUB CHAIR WITH PLASTIC FEET :: \$1,715

Composium Sharp club chair, square back, full valance, plastic feet, fully upholstered, grade 3 textile

SETTEE WITH METAL POLE FEET :: \$3,365

Composium Sharp settee, square back, three-quarter valance, brushed aluminum metal pole feet, fully upholstered, grade 7 textile



SOFA WITH WOOD SIDE RAILS :: \$4,297

Composium Sharp sofa, round back, arched valance, wood tapered square legs with side rails, fully upholstered, grade 7 textile

Features

- Club, settee and sofa sizes
- PatternMatch expertise and multi-upholstery options
- Durable steel-rail construction
- Three back types — square, round and scalloped
- Four valance styles — full, integrated, three-quarter and arched
- 11 foot styles including casters, metal pole and wood
- Optional clean-out space
- Optional tablet arm and wood arm cap
- Sustainable manufacturing and Take Back Program
- 300 lb weight capacity warranty per seat
- Optional power module available

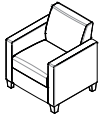
1. Product

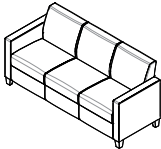
Model and Size	Code	Price	
Club	CP AS1 SN1	\$1,565	
Settee	CP AS1 SN2	\$2,085	
Sofa	CP AS1 SN3	\$2,585	

2. Arms

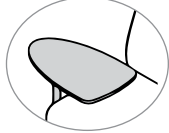
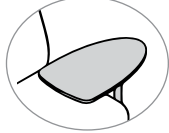
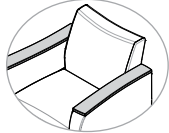
Tablet Arm	Code	Price	
Tablet Arm, Right	AX1	+ \$342	
Table Arm, Left	AX4	+ \$342	
Arm Cap	Code	Price	
Wood Arm Cap	ACP1	+ \$147	
Polyurethane Arm Cap	ACP2	+ \$147	

Polyurethane arm (ACP2) is not available with tablet arm.

3. Back

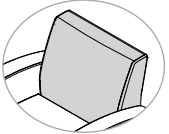
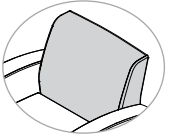
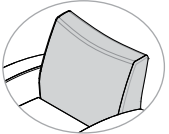
Back Shape	Code	Price	
Square	BS1	+ \$0	
Round	BS2	+ \$0	
Scalloped	BS3	+ \$0	

COMPOSIUM SHARP

GSA SIN #: 33721

4. Seat

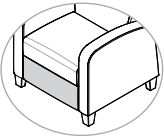
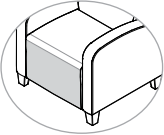
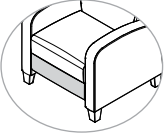
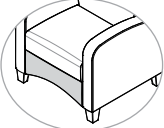
Valance Style	Code	Price	
Full	SV1	+ \$0	
Integrated	SV2	+ \$0	
Three-Quarter	SV3	+ \$0	
Arched	SV4	+ \$0	

Removable Cushion	Code	Price	
For Club Chair	SX1	+ \$59	
For Settee	SX1	+ \$118	
For Sofa	SX1	+ \$177	

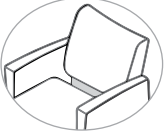
Clean-Out	Code	Price	
For Club Chair	SX2	+ \$0	
For Settee	SX2	+ \$0	
For Sofa	SX2	+ \$0	

Removable cushion not available with clean-out or integrated valance.

SHARP CLUB CHAIR, SETTEE AND SOFA

5. Foot

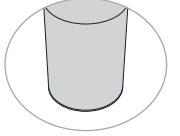
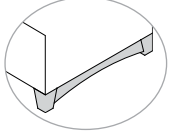
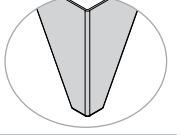
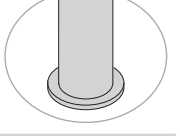
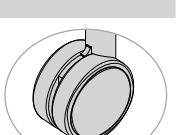
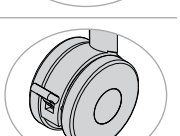
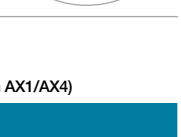
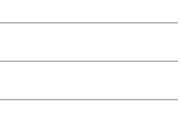
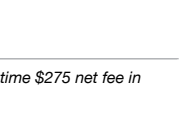
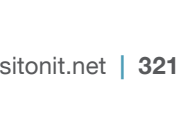
Foot Style and Color	Code	Price	
Feet			
Standard Plastic, Black	LS1	+ \$0	
Wood Tapered Square	LS12	+ \$140	
Wood Tapered Cylinder	LS11	+ \$140	
Wood Tapered Square With Side Rails	LS13	+ \$200	
Metal Angular, Brushed Aluminum	LS6	+ \$120	
Metal 1.5" Pole, Brushed Aluminum	LS7	+ \$120	
Metal 1.5" Pole, Silver Powder Coat	LS8	+ \$120	
Castors			
Non-Locking Caster, Black	LS2	+ \$100	
Non-Locking Caster, Silver	LS3	+ \$100	
Locking Caster, Black	LS4	+ \$120	
Locking Caster, Silver	LS5	+ \$120	

6. Frame (For Wooden Feet LS11/LS12/LS13 or Tablet Arm AX1/AX4)

Frame Finish Color	Code	Price	
Clear Maple	FCW1	+ \$0	
Medium Cherry	FCW2	+ \$0	
Amber Mahogany	FCW3	+ \$0	
Espresso	FCW4	+ \$0	
Stain-to-Match	STM	+ \$70	
New Custom Stain	STL	+ \$275	

New Custom Stain (STL): If stain is not in our library, add this one-time \$275 net fee in addition to the \$70 stain-to-match (STM) cost.

COMPOSIUM SHARP

GSA SIN #: 33721

7. Power

Power Location	Code	Price
Right Hand, Front of Unit	PFR	+ \$250
Left Hand, Front of Unit	PFL	+ \$250
Both Hands, Front of Unit	PFB	+ \$500

Power Color	Code	Price
Silver	PC2	+ \$0
Black	PC1	+ \$0

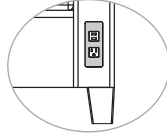
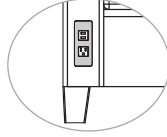

Power located on both hands (PFB) not available with club chair models (SN1).

8. Material

Protection	Code	Price		
CAL 133		Club	Settee	Sofa
CAL 133	UCAL	+ \$262	+ \$377	+ \$494

Cleaning	Code	Price		
Moisture Barrier		Club	Settee	Sofa
Moisture Barrier Seat	UM2	+ \$59	+ \$118	+ \$177
Moisture Barrier Back	UM1	+ \$59	+ \$118	+ \$177
Moisture Barrier Seat and Back	UM3	+ \$118	+ \$236	+ \$354

Fully Upholstered	Code	Price		
Seat, Back, Arm and Valance Upholstery		Club	Settee	Sofa
COM	COM	+ \$0	+ \$0	+ \$0
Fabric/Vinyl Grade 1	FG1/VG1	+ \$0	+ \$0	+ \$0
Fabric/Vinyl Grade 2	FG2/VG2	+ \$50	+ \$75	+ \$98
Fabric/Vinyl Grade 3	FG3/VG3	+ \$150	+ \$225	+ \$293
Fabric/Vinyl Grade 4	FG4/VG4	+ \$250	+ \$375	+ \$488
Fabric/Vinyl Grade 5	FG5/VG5	+ \$375	+ \$563	+ \$732
Fabric/Vinyl Grade 6	FG6/VG6	+ \$550	+ \$825	+ \$1,073
Fabric/Vinyl Grade 7	FG7/VG7	+ \$775	+ \$1,163	+ \$1,512
COL	COL	+ \$800	+ \$1,196	+ \$1,550
Leather Grade 1	LG1	+ \$800	+ \$1,196	+ \$1,550
Leather Grade 2	LG2	+ \$1,050	+ \$1,570	+ \$2,034
Leather Grade 3	LG3	+ \$1,450	+ \$2,168	+ \$2,809

SHARP CLUB CHAIR, SETTEE AND SOFA

8. Material (Cont.)

Multi-Upholstery	Code	Price		
		Club	Settee	Sofa
Multi-Upholstery Upcharge	UMU	+ \$113	+ \$113	+ \$113

Seat Textile Only	Code	Club	Settee	Sofa
COM	COM	+ \$0	+ \$0	+ \$0
Fabric/Vinyl Grade 1	FG1/VG1	+ \$0	+ \$0	+ \$0
Fabric/Vinyl Grade 2	FG2/VG2	+ \$8	+ \$14	+ \$20
Fabric/Vinyl Grade 3	FG3/VG3	+ \$22	+ \$41	+ \$59
Fabric/Vinyl Grade 4	FG4/VG4	+ \$37	+ \$68	+ \$98
Fabric/Vinyl Grade 5	FG5/VG5	+ \$55	+ \$101	+ \$147
Fabric/Vinyl Grade 6	FG6/VG6	+ \$80	+ \$148	+ \$215
Fabric/Vinyl Grade 7	FG7/VG7	+ \$113	+ \$209	+ \$303
COL	COL	+ \$117	+ \$214	+ \$310
Leather Grade 1	LG1	+ \$117	+ \$214	+ \$310
Leather Grade 2	LG2	+ \$153	+ \$281	+ \$407
Leather Grade 3	LG3	+ \$211	+ \$388	+ \$562

Back Textile Only	Code	Club	Settee	Sofa
COM	COM	+ \$0	+ \$0	+ \$0
Fabric/Vinyl Grade 1	FG1/VG1	+ \$0	+ \$0	+ \$0
Fabric/Vinyl Grade 2	FG2/VG2	+ \$14	+ \$27	+ \$39
Fabric/Vinyl Grade 3	FG3/VG3	+ \$42	+ \$81	+ \$115
Fabric/Vinyl Grade 4	FG4/VG4	+ \$69	+ \$135	+ \$192
Fabric/Vinyl Grade 5	FG5/VG5	+ \$103	+ \$202	+ \$287
Fabric/Vinyl Grade 6	FG6/VG6	+ \$151	+ \$296	+ \$421
Fabric/Vinyl Grade 7	FG7/VG7	+ \$213	+ \$417	+ \$593
COL	COL	+ \$220	+ \$428	+ \$608
Leather Grade 1	LG1	+ \$220	+ \$428	+ \$608
Leather Grade 2	LG2	+ \$288	+ \$562	+ \$798
Leather Grade 3	LG3	+ \$398	+ \$776	+ \$1,102

Arms Textile Only	Code	Club	Settee	Sofa
COM	COM	+ \$0	+ \$0	+ \$0
Fabric/Vinyl Grade 1	FG1/VG1	+ \$0	+ \$0	+ \$0
Fabric/Vinyl Grade 2	FG2/VG2	+ \$22	+ \$22	+ \$21
Fabric/Vinyl Grade 3	FG3/VG3	+ \$66	+ \$64	+ \$61
Fabric/Vinyl Grade 4	FG4/VG4	+ \$109	+ \$107	+ \$102
Fabric/Vinyl Grade 5	FG5/VG5	+ \$164	+ \$160	+ \$152
Fabric/Vinyl Grade 6	FG6/VG6	+ \$240	+ \$235	+ \$223
Fabric/Vinyl Grade 7	FG7/VG7	+ \$338	+ \$331	+ \$314
COL	COL	+ \$349	+ \$340	+ \$322
Leather Grade 1	LG1	+ \$349	+ \$340	+ \$322
Leather Grade 2	LG2	+ \$458	+ \$447	+ \$423
Leather Grade 3	LG3	+ \$632	+ \$616	+ \$584

8. Material (Cont.)

Multi-Upholstery (Cont.)	Code	Price		
		Club	Settee	Sofa
Valance Textile Only				
COM	COM	+ \$0	+ \$0	+ \$0
Fabric/Vinyl Grade 1	FG1/VG1	+ \$0	+ \$0	+ \$0
Fabric/Vinyl Grade 2	FG2/VG2	+ \$8	+ \$14	+ \$20
Fabric/Vinyl Grade 3	FG3/VG3	+ \$22	+ \$41	+ \$59
Fabric/Vinyl Grade 4	FG4/VG4	+ \$37	+ \$68	+ \$98
Fabric/Vinyl Grade 5	FG5/VG5	+ \$55	+ \$101	+ \$147
Fabric/Vinyl Grade 6	FG6/VG6	+ \$80	+ \$148	+ \$215
Fabric/Vinyl Grade 7	FG7/VG7	+ \$113	+ \$209	+ \$303
COL	COL	+ \$117	+ \$214	+ \$310
Leather Grade 1	LG1	+ \$117	+ \$214	+ \$310
Leather Grade 2	LG2	+ \$153	+ \$281	+ \$407
Leather Grade 3	LG3	+ \$211	+ \$388	+ \$562

If different fabrics are selected for the seat, back, arms and/or valance add the multiple upholstery upcharge (IMU) as well, even if the two fabrics are the same grade.

Please reference the Textile Reference Guide for pricing on fabric over grade 7 and leather over grade 3.

9. Packaging

Packaging	Code	Price
Fully Assembled in a Carton	P1	+ \$0

SPECIFICATIONS

Model:	Club CP AS1 SN1	Settee CP AS1 SN2	Sofa CP AS1 SN3
Height	34"	34"	34"
Width	31"	53"	75"
Depth	28"	28"	28"
Seat Width	22"	44"	66"
Seat Depth	19.5"	19.5"	19.5"
Seat Height	19.5"	19.5"	19.5"
Back Height	16"	16"	16"
Arm Height	26"	26"	26"
Weight	70 lb	115 lb	160 lb
COM (Fully Upholstered)	5.3 yd	7.9 yd	10.5 yd
COM (Multi-Upholstery)			
Seat Only	1.9 yd	3.2 yd	3.8 yd
Back Only	2.2 yd	4.1 yd	5.8 yd
Arms Only	3.8 yd	3.8 yd	3.8 yd
Valance Only	1 yd	1.3 yd	1.3 yd
COL (Fully Upholstered)	83.3 sq ft	122.5 sq ft	163.7 sq ft
COL (Multi-Upholstery)			
Seat Only	29.4 sq ft	49 sq ft	58.8 sq ft
Back Only	33.4 sq ft	63.7 sq ft	90.2 sq ft
Arms Only	58.8 sq ft	58.8 sq ft	58.8 sq ft
Valance Only	14.7 sq ft	19.6 sq ft	19.6 sq ft
Weight Capacity	300 lb	300 lb	300 lb
Warranty (Per Seat)			

Yardage requirements for COM and COL are for solid and non-directional fabrics. Additional material may be required for larger repeating patterns.



Settee with Metal Pole Feet

Composium

OTTOMAN AND BENCHES

Perfect harmony.

This robust bench and ottoman collection complement all Composium® lounge seating models. Three bench sizes—plus an ottoman—provide strategic accents for a functional and modular seating solution. An optional removable cushion and 10 foot styles make this line a comfortable and stylish soft seating choice. Composium is rugged and easy to maintain with field-replaceable parts and durable steel-rail construction in benches that withstands tough environments. Our PatternMatch® expertise ensures that every chair is a perfect match.



1-Seat Bench With Wood Feet

Featured Models

OTTOMAN WITH CASTERS :: \$919

Composium ottoman, non-locking casters, fully upholstered, grade 3 textile

1-SEAT BENCH WITH WOOD FEET :: \$1,166

Composium single-seat bench, wood tapered square feet, fully upholstered, grade 3 textile



2-SEAT BENCH WITH METAL POLE FEET :: \$1,461

Composium double-seat bench, brushed aluminum metal pole feet, fully upholstered, grade 3 vinyl

Features

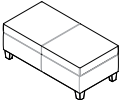
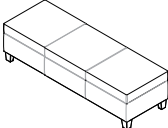

- Three bench sizes and an ottoman
- PatternMatch expertise and multi-upholstery options
- Durable steel-rail construction
- 11 foot styles including casters, metal pole and wood
- Sustainable manufacturing and Take Back Program
- 300 lb weight capacity warranty per seat
- Optional power module available

1. Product

Model	Code	Price	
Ottoman	CP FS1	\$751	
Single-Seat Bench	CP FS2 SN1	\$951	
Double-Seat Bench	CP FS2 SN2	\$1,251	
Three-Seat Bench	CP FS2 SN3	\$1,551	

OTTOMAN AND BENCHES

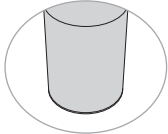
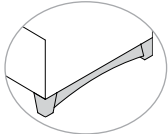
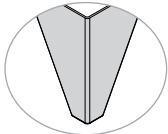
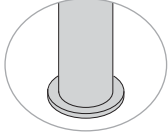
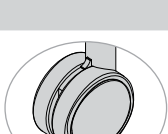
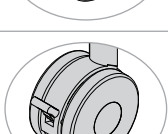
2. Foot

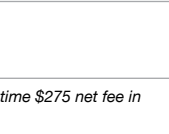
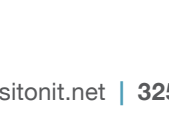
Foot Style and Color	Code	Price	
Feet			
Standard Plastic, Black	LS1	+ \$0	
Wood Tapered Square	LS12	+ \$140	
Wood Tapered Cylinder	LS11	+ \$140	
Wood Tapered Square With Side Rails	LS13	+ \$200	
Metal Angular, Brushed Aluminum	LS6	+ \$120	
Metal 1.5" Pole, Brushed Aluminum	LS7	+ \$120	
Metal 1.5" Pole, Silver Powder Coat	LS8	+ \$120	
Casters			
Non-Locking Caster, Black	LS2	+ \$100	
Non-Locking Caster, Silver	LS3	+ \$100	
Locking Caster, Black	LS4	+ \$120	
Locking Caster, Silver	LS5	+ \$120	

3. Frame (For Wooden Feet LS11/LS12/LS13)

Frame Finish Color	Code	Price	
Clear Maple	FCW1	+ \$0	
Medium Cherry	FCW2	+ \$0	
Amber Mahogany	FCW3	+ \$0	
Espresso	FCW4	+ \$0	
Stain-to-Match	STM	+ \$70	
New Custom Stain	STL	+ \$275	

New Custom Stain (STL): If stain is not in our library, add this one-time \$275 net fee in addition to the \$70 stain-to-match (STM) cost.

4. Power

Power Location	Code	Price
Right Hand, Front of Unit	PFR	+ \$250
Left Hand, Front of Unit	PFL	+ \$250
Both Hands, Front of Unit	PFB	+ \$500

Power Color	Code	Price
Silver	PC2	+ \$0
Black	PC1	+ \$0

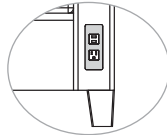
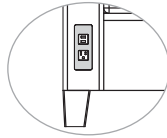

Ottoman with Casters

Power located on both hands (PFB) not available with ottoman (SN1) or single-seat bench models (SN1)

5. Material

Protection	Code	Price			
CAL 133		Ottoman	1-Seat Bench	2-Seat Bench	3-Seat Bench
CAL 133	UCAL	+ \$88	+ \$88	+ \$175	+ \$262

Cleaning	Code	Price			
Moisture Barrier		Ottoman	1-Seat Bench	2-Seat Bench	3-Seat Bench
Moisture Barrier Seat	UM2	+ \$59	+ \$59	+ \$118	+ \$177

Fully Upholstered	Code	Price			
Seat and Valance Textile		Ottoman	1-Seat Bench	2-Seat Bench	3-Seat Bench
COM	COM	+ \$0	+ \$0	+ \$0	+ \$0
Fabric/Vinyl Grade 1	FG1/VG1	+ \$0	+ \$0	+ \$0	+ \$0
Fabric/Vinyl Grade 2	FG2/VG2	+ \$23	+ \$25	+ \$30	+ \$35
Fabric/Vinyl Grade 3	FG3/VG3	+ \$68	+ \$75	+ \$90	+ \$105
Fabric/Vinyl Grade 4	FG4/VG4	+ \$113	+ \$125	+ \$150	+ \$175
Fabric/Vinyl Grade 5	FG5/VG5	+ \$169	+ \$188	+ \$225	+ \$263
Fabric/Vinyl Grade 6	FG6/VG6	+ \$248	+ \$275	+ \$330	+ \$385
Fabric/Vinyl Grade 7	FG7/VG7	+ \$349	+ \$388	+ \$465	+ \$543
COL	COL	+ \$363	+ \$371	+ \$447	+ \$523
Leather Grade 1	LG1	+ \$363	+ \$371	+ \$447	+ \$523
Leather Grade 2	LG2	+ \$476	+ \$487	+ \$586	+ \$686
Leather Grade 3	LG3	+ \$657	+ \$672	+ \$809	+ \$947

GSA SIN #: 33721

5. Material (Cont.)

Multi-Upholstery	Code	Price			
		Ottoman	1-Seat Bench	2-Seat Bench	3-Seat Bench
Multi-Upholstery Upcharge	UMU	+ \$113	+ \$113	+ \$113	+ \$113
Seat Textile Only		Ottoman	1-Seat Bench	2-Seat Bench	3-Seat Bench
COM	COM	+ \$0	+ \$0	+ \$0	+ \$0
Fabric/Vinyl Grade 1	FG1/VG1	+ \$0	+ \$0	+ \$0	+ \$0
Fabric/Vinyl Grade 2	FG2/VG2	+ \$12	+ \$13	+ \$15	+ \$18
Fabric/Vinyl Grade 3	FG3/VG3	+ \$34	+ \$38	+ \$45	+ \$53
Fabric/Vinyl Grade 4	FG4/VG4	+ \$57	+ \$63	+ \$75	+ \$88
Fabric/Vinyl Grade 5	FG5/VG5	+ \$85	+ \$94	+ \$113	+ \$132
Fabric/Vinyl Grade 6	FG6/VG6	+ \$124	+ \$138	+ \$165	+ \$193
Fabric/Vinyl Grade 7	FG7/VG7	+ \$175	+ \$194	+ \$233	+ \$272
COL	COL	+ \$182	+ \$186	+ \$224	+ \$262
Leather Grade 1	LG1	+ \$182	+ \$186	+ \$224	+ \$262
Leather Grade 2	LG2	+ \$238	+ \$244	+ \$293	+ \$343
Leather Grade 3	LG3	+ \$329	+ \$336	+ \$405	+ \$474
Valance Textile Only		Ottoman	1-Seat Bench	2-Seat Bench	3-Seat Bench
COM	COM	+ \$0	+ \$0	+ \$0	+ \$0
Fabric/Vinyl Grade 1	FG1/VG1	+ \$0	+ \$0	+ \$0	+ \$0
Fabric/Vinyl Grade 2	FG2/VG2	+ \$12	+ \$13	+ \$15	+ \$18
Fabric/Vinyl Grade 3	FG3/VG3	+ \$34	+ \$38	+ \$45	+ \$53
Fabric/Vinyl Grade 4	FG4/VG4	+ \$57	+ \$63	+ \$75	+ \$88
Fabric/Vinyl Grade 5	FG5/VG5	+ \$85	+ \$94	+ \$113	+ \$132
Fabric/Vinyl Grade 6	FG6/VG6	+ \$124	+ \$138	+ \$165	+ \$193
Fabric/Vinyl Grade 7	FG7/VG7	+ \$175	+ \$194	+ \$233	+ \$272
COL	COL	+ \$182	+ \$186	+ \$224	+ \$262
Leather Grade 1	LG1	+ \$182	+ \$186	+ \$224	+ \$262
Leather Grade 2	LG2	+ \$238	+ \$244	+ \$293	+ \$343
Leather Grade 3	LG3	+ \$329	+ \$336	+ \$405	+ \$474

If different fabrics are selected for the seat and valance add the multiple upholstery upcharge (UMU) as well, even if the two fabrics are the same grade.
Please reference the Textile Reference Guide for pricing on fabric over grade 7 and leather over grade 3.

6. Packaging

Packaging	Code	Price
Fully Assembled in a Carton	P1	+ \$0

SPECIFICATIONS

Model:	CP FS1 Ottoman	CP FS2 SN1 1-Seat Bench
Seat Width	22"	26"
Seat Depth	22"	24"
Seat Height	18.5"	18.5"
Weight	28 lb	60 lb
COM (Fully Upholstered)	3.2 yd	3.2 yd
COM (Multi-Upholstery) Seat Only	1.9 yd	1.9 yd
Valance Only	1.9 yd	1.9 yd
COL (Fully Upholstered)	49 sq ft	49 sq ft
COL (Multi-Upholstery) Seat Only	29.4 sq ft	29.4 sq ft
Valance Only	29.4 sq ft	29.4 sq ft
Weight Capacity Warranty (Per Seat)	300 lb	300 lb

NOTE: Yardage requirements for COM and COL are for solid and non-directional fabrics. Additional material may be required for larger repeating patterns.

SPECIFICATIONS

Model:	CP FS2 SN2 2-Seat Bench	CP FS2 SN3 3-Seat Bench
Seat Width	48"	70"
Seat Depth	24"	24"
Seat Height	18.5"	18.5"
Weight	91 lb	106 lb
COM (Fully Upholstered)	3.8 yd	4.4 yd
COM (Multi-Upholstery) Seat Only	2.9 yd	2.9 yd
Valance Only	2.9 yd	2.9 yd
COL (Fully Upholstered)	58.8 sq ft	68.6 sq ft
COL (Multi-Upholstery) Seat Only	44.1 sq ft	44.1 sq ft
Valance Only	44.1 sq ft	44.1 sq ft
Weight Capacity Warranty (Per Seat)	300 lb	300 lb

NOTE: Yardage requirements for COM and COL are for solid and non-directional fabrics. Additional material may be required for larger repeating patterns.



2-Seat Bench With Metal Pole Feet

Envoi

LOUNGE SEATING

Lean back lounge.

To reach the height of comfort, you should start at its roots. A place where everything feels natural and effortless. Get ready to discover what's possible when innovation comes to life because this is the first-ever flexing solution for lounge. It moves you. It moves with you. Envoi is a pure exposition of comfort-meets-motion with unmatched, unencumbered design.



Highback With Wood Base

Featured Models

MIDBACK WITH METAL BASE :: \$1,548

Midback, 360-degree swivel, charcoal metal base, fully upholstered, grade 1 textile

HIGHBACK WITH METAL BASE :: \$1,922

Highback, 360-degree swivel, polished aluminum metal base, fully upholstered, grade 1 textile



HIGHBACK WITH WOOD BASE :: \$2,299

Highback, 360-degree swivel, wood base, fully upholstered, grade 4 textile

Features

- Designed by Claudio Bellini
- Backrest flexes and moves when you recline
- Petal-like pieces surround with comfort
- Available in midback or highback
- 4-star base available in three wood or metal finishes
- Auto-return cylinder available on metal base only
- 300 lb weight capacity warranty

1. Product

Back Size and Style	Code	Price	
Midback Lounge	ENV BH4	\$1,548	
Highback Lounge	ENV BH5	\$1,689	

2. Base

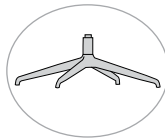
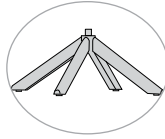
Cylinder	Code	Price	
360-Degree Swivel	CH5	+ \$0	
Auto-Return, Fixed Height	CH6	+ \$25	
Base Material	Code	Price	
Metal	BMM	+ \$0	
Wood	BMW	+ \$400	

Auto-return cylinder (CH6) is only available with metal base (BMM).

2. Base (Cont.)

Base Color	Code	Price	
Metal Color			
Charcoal	BF04	+ \$0	
Bronze	BF05	+ \$0	
Polished Aluminum	BF07	+ \$113	
Wood Cap Stain			
Uptown	BF08	+ \$0	
Colombian	BF09	+ \$0	
Skyline	BF10	+ \$0	

3. Material

Protection	Code	Price	
CAL 133	UCAL	+\$262	
Cleaning	Code	Price	
Moisture Barrier Seat	UM2	+\$59	
Moisture Barrier Back	UM1	+\$59	
Moisture Barrier Back and Seat	UM3	+\$118	
Fully Upholstered	Code	Price	
Midback (For BH4) Textile			
COM	COM	+ \$0	
Fabric/Vinyl Grade 1	FG1/VG1	+ \$0	
Fabric/Vinyl Grade 2	FG2/VG2	+ \$42	
Fabric/Vinyl Grade 3	FG3/VG3	+ \$112	
Fabric/Vinyl Grade 4	FG4/VG4	+ \$196	
Fabric/Vinyl Grade 5	FG5/VG5	+ \$336	
Fabric/Vinyl Grade 6	FG6/VG6	+ \$476	
Fabric/Vinyl Grade 7	FG7/VG7	+ \$616	
COL	COL	+ \$900	
Leather Grade1	LG1	+ \$1,140	
Leather Grade 2	LG2	+ \$1,140	
Leather Grade 3	LG3	+ \$1,440	

3. Material (Cont.)

Fully Upholstered	Code	Price
Highback (For BH5) Textile		
COM	COM	+ \$0
Fabric/Vinyl Grade 1	FG1/VG1	+ \$0
Fabric/Vinyl Grade 2	FG2/VG2	+ \$45
Fabric/Vinyl Grade 3	FG3/VG3	+ \$120
Fabric/Vinyl Grade 4	FG4/VG4	+ \$210
Fabric/Vinyl Grade 5	FG5/VG5	+ \$360
Fabric/Vinyl Grade 6	FG6/VG6	+ \$510
Fabric/Vinyl Grade 7	FG7/VG7	+ \$660
COL	COL	+ \$945
Leather Grade 1	LG1	+ \$945
Leather Grade 2	LG2	+ \$1,197
Leather Grade 3	LG3	+ \$1,512



3. Material (Cont.)

Multi-Upholstery	Code	Price	
Multi-Upholstery Upcharge	UMU	+ \$75	
Midback Textile		Seat Only	Back and Arms
COM	COM	+ \$0	+ \$0
Fabric/Vinyl Grade 1	FG1/VG1	+ \$0	+ \$0
Fabric/Vinyl Grade 2	FG2/VG2	+ \$15	+ \$38
Fabric/Vinyl Grade 3	FG3/VG3	+ \$40	+ \$104
Fabric/Vinyl Grade 4	FG4/VG4	+ \$70	+ \$182
Fabric/Vinyl Grade 5	FG5/VG5	+ \$120	+ \$312
Fabric/Vinyl Grade 6	FG6/VG6	+ \$170	+ \$443
Fabric/Vinyl Grade 7	FG7/VG7	+ \$220	+ \$573
COL	COL	+ \$315	+ \$828
Leather Grade 1	LG1	+ \$315	+ \$828
Leather Grade 2	LG2	+ \$399	+ \$1,049
Leather Grade 3	LG3	+ \$504	+ \$1,326
Highback (For BH5) Textile		Seat Only	Back and Arms
COM	COM	+ \$0	+ \$0
Fabric/Vinyl Grade 1	FG1/VG1	+ \$0	+ \$0
Fabric/Vinyl Grade 2	FG2/VG2	+ \$15	+ \$41
Fabric/Vinyl Grade 3	FG3/VG3	+ \$40	+ \$109
Fabric/Vinyl Grade 4	FG4/VG4	+ \$70	+ \$192
Fabric/Vinyl Grade 5	FG5/VG5	+ \$120	+ \$329
Fabric/Vinyl Grade 6	FG6/VG6	+ \$170	+ \$467
Fabric/Vinyl Grade 7	FG7/VG7	+ \$220	+ \$604
COL	COL	+ \$315	+ \$866
Leather Grade 1	LG1	+ \$315	+ \$866
Leather Grade 2	LG2	+ \$399	+ \$1,097
Leather Grade 3	LG3	+ \$504	+ \$1,386

If different fabrics are selected for the seat and back/arms, add the multiple upholstery upcharge as well, even if the fabrics are the same grade.

Please reference the Textile Reference Guide for pricing on fabric over grade 7 and leather over grade 3.

4. Packaging

Packaging	Code	Price
Partially Assembled in Carton	P3	+ \$0
Assembled in Carton	P1	+ \$80

SPECIFICATIONS

Model:	ENV BH4 Midback Lounge	ENV BH5 Highback Lounge
Height	34.75"	41.5"
Width	27"	27"
Depth	26"	26"
Seat Depth	18"	18"
Seat Height	16.5"	16.5"
Back Height	21.25"	28"
Weight	42 lb (BMM) 55.5 lb (BMW)	54 lb (BMM) 67.5 lb (BMW)
COM (Fully Upholstered)	3 yd	3.25 yd
COM (Multi-Upholstery)		
Back and Arms Only	2.5 yd	2.75 yd
Seat Cushion Only	1 yd	1 yd
COL (Fully Upholstered)	50 sq ft	55 sq ft
COL (Multi-Upholstery)		
Back and Arms Only	40 sq ft	45 sq ft
Seat Cushion Only	15 sq ft	15 sq ft
Weight Capacity Warranty	300 lb	300 lb

Metal base (BMM). Wood base (BMW).



Highback With Metal Base

Gobi

LOUNGE SEATING

Huddle with inspiration.

Work mode. Wait mode. Let's-get-it-done mode.

Today's open and collaborative spaces should help you shift spontaneously. And Gobi is the perfect huddle partner. Its sculpted comfort and modern, easygoing design can carry you through the many modes you find yourself in—so that another day at the office feels like anything but.



Charcoal Metal Base

Featured Models

CHARCOAL METAL BASE :: \$1,408

Midback, charcoal metal base, free-swivel fixed-height cylinder, fully upholstered, grade 1 textile

POLISHED ALUMINUM BASE :: \$1,756

Midback, polished aluminum metal base, auto-return fixed-height cylinder, fully upholstered, grade 4 textile

WOOD BASE :: \$2,098

Midback, free-swivel fixed-height cylinder, wood base, fully upholstered, grade 4 textile

Features

- Minimalist design with crisp lines and tailored stitching
- Flared arms allow room for bags, laptops and more
- Soft, sculpted curves provide extra comfort
- Multi-upholstery options on seat cushion
- Bases available in three metal and wood finishes
- Auto-return cylinder available on metal base only
- 300 lb weight capacity warranty

1. Product

Back Size and Style	Code	Price	
Midback Lounge	GBI BH4	\$1,408	

2. Base

Cylinder	Code	Price	
Free Swivel, Fixed Height	CH5	+ \$0	
Auto-Return, Fixed Height	CH6	+ \$25	

Base Material	Code	Price	
Metal	BMM	+ \$0	
Wood	BMW	+ \$400	

Base Color	Code	Price	
Metal Color			
Charcoal	BF04	+ \$0	
Bronze	BF05	+ \$0	
Polished Aluminum	BF07	+ \$113	
Wood Cap Stain			
Uptown	BF08	+ \$0	
Colombian	BF09	+ \$0	
Skyline	BF10	+ \$0	

Auto-return cylinder (CH6) is only available with metal base (BMM).

LOUNGE SEATING

2. Base (Cont.)

Glides	Code	Price	
Standard Multi-Surface Glides	GL1	+ \$0	

3. Material

Protection	Code	Price	
CAL 133	UCAL	+\$262	

Cleaning	Code	Price	
Moisture Barrier Seat	UM2	+\$59	
Moisture Barrier Back	UM1	+\$59	
Moisture Barrier Back and Seat	UM3	+\$118	

Fully Upholstered	Code	Price	
COM	COM	+ \$0	
Fabric/Vinyl Grade 1	FG1/VG1	+ \$0	
Fabric/Vinyl Grade 2	FG2/VG2	+ \$45	
Fabric/Vinyl Grade 3	FG3/VG3	+ \$120	
Fabric/Vinyl Grade 4	FG4/VG4	+ \$210	
Fabric/Vinyl Grade 5	FG5/VG5	+ \$360	
Fabric/Vinyl Grade 6	FG6/VG6	+ \$510	
Fabric/Vinyl Grade 7	FG7/VG7	+ \$660	
COL	COL	+ \$1,181	
Leather Grade 1	LG1	+ \$1,181	
Leather Grade 2	LG2	+ \$1,496	
Leather Grade 3	LG3	+ \$1,890	

Multi-Upholstery	Code	Price	
Multi-Upholstery Upcharge	UMU	+ \$75	

Seat Shell Textile Only			
COM	COM	+ \$0	
Fabric/Vinyl Grade 1	FG1/VG1	+ \$0	
Fabric/Vinyl Grade 2	FG2/VG2	+ \$30	
Fabric/Vinyl Grade 3	FG3/VG3	+ \$80	
Fabric/Vinyl Grade 4	FG4/VG4	+ \$140	
Fabric/Vinyl Grade 5	FG5/VG5	+ \$240	
Fabric/Vinyl Grade 6	FG6/VG6	+ \$340	
Fabric/Vinyl Grade 7	FG7/VG7	+ \$440	
COL	COL	+ \$788	
Leather Grade 1	LG1	+ \$788	
Leather Grade 2	LG2	+ \$998	
Leather Grade 3	LG3	+ \$1,260	

3. Material (Cont.)

Multi-Upholstery	Code	Price
Seat Cushion Textile Only		
COM	COM	+ \$0
Fabric/Vinyl Grade 1	FG1/VG1	+ \$0
Fabric/Vinyl Grade 2	FG2/VG2	+ \$15
Fabric/Vinyl Grade 3	FG3/VG3	+ \$40
Fabric/Vinyl Grade 4	FG4/VG4	+ \$70
Fabric/Vinyl Grade 5	FG5/VG5	+ \$120
Fabric/Vinyl Grade 6	FG6/VG6	+ \$170
Fabric/Vinyl Grade 7	FG7/VG7	+ \$220
COL	COL	+ \$394
Leather Grade 1	LG1	+ \$394
Leather Grade 2	LG2	+ \$499
Leather Grade 3	LG3	+ \$630

Textiles approved for Nano and Paseo apply to Gobi. Refer to textile compatibility tool for up-to-date offerings.

If different fabrics are selected for the seat cushion and shell, add the multiple upholstery upcharge as well, even if the fabrics are the same grade.

Please reference the Textile Reference Guide for pricing on fabric over grade 7 and leather over grade 3.

4. Packaging

Packaging	Code	Price
Partially Assembled in Carton	P3	+ \$0
Assembled in Carton	P1	+ \$80

SPECIFICATIONS

Model:	GOBI BH4 Midback Lounge
Height	31.5"
Width	30.25"
Depth	31"
Seat Depth	19"
Seat Height	17.25"
Back Height	21.5"
Weight	37.5 lb (BMM) 51 lb (BMW)
COM (Fully Upholstered)	3.5 yd
COM (Multi-Upholstery)	
Seat Shell Only	2.8 yd
Seat Cushion Only	1 yd
COL (Single Upholstery)	55 sq ft
COL (Fully Upholstered)	
Seat Shell Only	48 sq ft
Seat Cushion Only	15 sq ft
Weight Capacity Warranty	300 lb

Metal base (BMM). Wood base (BMW).



Wood Base

Nano

MODULAR LOUNGE TYPICALS

Easy from every angle.

Meet Nano, our uniquely designed and easy-to-spec modular lounge collection. Featuring a triangle, diamond, trapezoid and boomerang, Nano's geometric shapes make on-the-spot configuration easy and fun. Create a new, one-of-a-kind look every time in thousands of combinations.

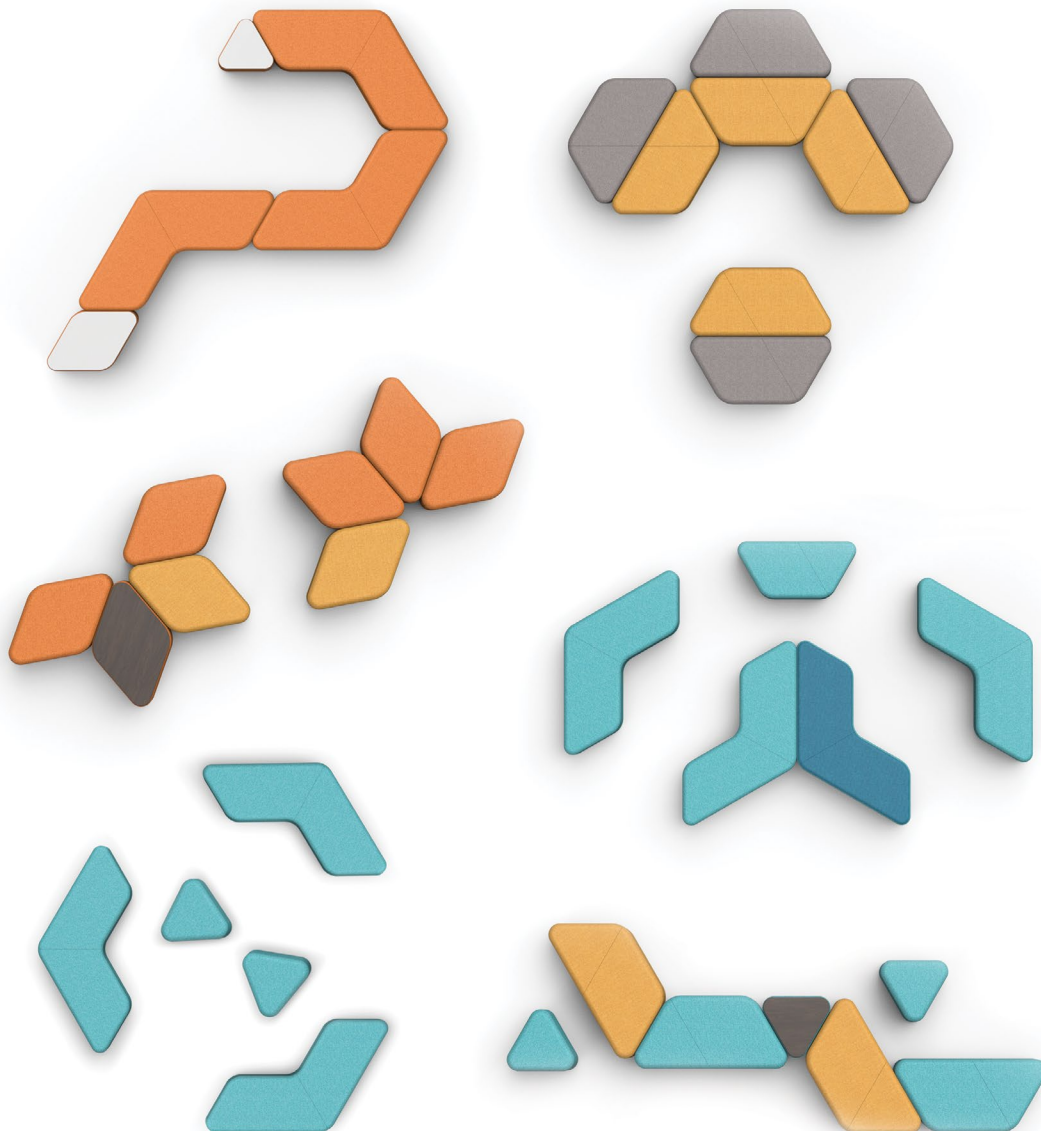

GSA SIN #: 33721

Typical 1

Line	Category	Part Number	Qty	Description	Unit Price	Ext. Price	
1	Table	NNO FS14 TM4 TSS2 FG1 LS1	1	Diamond, Solid Surface Tabletop, Fixed Glides, Fully Upholstered, Grade 1 Textile	\$1,506	\$1,506	
2	Seating	NNO FS16 TM0 FG1 LS1	3	Boomerang, Fixed Glides, Fully Upholstered, Grade 1 Textile	\$2,439	\$7,317	
3	Table	NNO FS13 TM4 TSS2 FG1 LS1	1	Triangle, Solid Surface Tabletop, Fixed Glides, Fully Upholstered, Grade 1 Textile	\$1,062	\$1,062	

TOTAL: \$9,885

Typical 2

Line	Category	Part Number	Qty	Description	Unit Price	Ext. Price	
1	Seating	NNO FS16 TM0 FG1 LS1	4	Boomerang, Fixed Glides, Fully Upholstered, Grade 1 Textile	\$2,439	\$9,756	
2	Seating	NNO FS15 TM0 FG1 LS1	1	Trapezoid, Fixed Glides, Fully Upholstered, Grade 1 Textile	\$1,031	\$1,031	

TOTAL: \$10,787

Typical 3

Line	Category	Part Number	Qty	Description	Unit Price	Ext. Price	
1	Seating	NNO FS13 TM0 FG1 LS1	2	Triangle, Fixed Glides, Fully Upholstered, Grade 1 Textile	\$422	\$1,266	
2	Table	NNO FS13 TM3 TL15 FG1 LS1	1	Triangle, Laminate Tabletop, Fixed Glides, Fully Upholstered, Grade 1 Textile	\$562	\$562	
3	Seating	NNO FS15 TM0 FG1 LS1	4	Trapezoid, Fixed Glides, Fully Upholstered, Grade 1 Textile	\$1,031	\$4,124	

TOTAL: \$5,530

Typical 4

Line	Category	Part Number	Qty	Description	Unit Price	Ext. Price	
1	Seating	NNO FS14 TM0 FG1 LS1	7	Diamond, Fixed Glides, Fully Upholstered, Grade 1 Textile	\$610	\$4,270	
2	Table	NNO FS14 TM3 TL15 FG1 LS1	1	Diamond, Laminate Tabletop, Fixed Glides, Fully Upholstered, Grade 1 Textile	\$750	\$750	

TOTAL: \$5,020

GSA SIN #: 33721

Typical 5

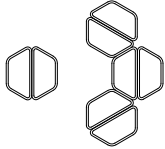
Line	Category	Part Number	Qty	Description	Unit Price	Ext. Price	
1	Seating	NNO FS15 TM0 FG1 LS1	8	Trapezoid, Fixed Glides, Fully Upholstered, Grade 1 Textile	\$1,031	\$8,248	
						TOTAL: \$8,248	

Typical 6

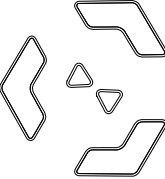
Line	Category	Part Number	Qty	Description	Unit Price	Ext. Price	
1	Seating	NNO FS16 TM0 FG1 LS1	3	Boomerang, Fixed Glides, Fully Upholstered, Grade 1 Textile	\$2,439	\$7,317	
2	Seating	NNO FS13 TM0 FG1 LS1	2	Triangle, Fixed Glides, Fully Upholstered, Grade 1 Textile	\$422	\$844	
						TOTAL: \$8,161	

Typical 7

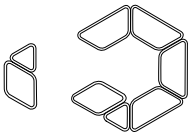
Line	Category	Part Number	Qty	Description	Unit Price	Ext. Price	
1	Table	NNO FS13 TM3 TL13 FG1 LS1	2	Triangle, Laminate Tabletop, Fixed Glides, Fully Upholstered, Grade 1 Textile	\$562	\$1,124	
2	Seating	NNO FS14 TM0 FG1 LS1	2	Diamond, Fixed Glides, Fully Upholstered, Grade 1 Textile	\$610	\$1,220	
3	Seating	NNO FS15 TM0 FG1 LS1	4	Trapezoid, Fixed Glides, Fully Upholstered, Grade 1 Textile	\$1,031	\$4,124	
						TOTAL: \$6,468	

Typical 8

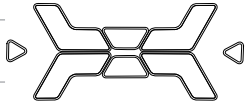
Line	Category	Part Number	Qty	Description	Unit Price	Ext. Price	
1	Seating	NNO FS13 TM0 FG1 LS1	2	Triangle, Fixed Glides, Fully Upholstered, Grade 1 Textile	\$422	\$844	
2	Seating	NNO FS16 TM0 FG1 LS1	4	Boomerang, Fixed Glides, Fully Upholstered, Grade 1 Textile	\$2,439	\$9,756	
3	Seating	NNO FS15 TM0 FG1 LS1	2	Trapezoid, Fixed Glides, Fully Upholstered, Grade 1 Textile	\$1,031	\$2,062	
						TOTAL: \$12,662	

GSA SIN #: 33721

Typical 9

Line	Category	Part Number	Qty	Description	Unit Price	Ext Price	
1	Table	NNO FS13 TM4 TSS2 FG1 LS1	5	Triangle, Solid Surface Tabletop, Fixed Glides, Fully Upholstered, Grade 1 Textile	\$1,062	\$5,310	
2	Seating	NNO FS16 TM0 FG1 LS1	3	Boomerang, Fixed Glides, Fully Upholstered, Grade 1 Textile	\$2,439	\$7,317	
3	Seating	NNO FS15 TM0 FG1 LS1	6	Trapezoid, Fixed Glides, Fully Upholstered, Grade 1 Textile	\$1,031	\$6,186	

TOTAL: \$18,813

Typical 10

Line	Category	Part Number	Qty	Description	Unit Price	Ext Price	
1	Seating	NNO FS15 TM0 FG1 LS1	4	Trapezoid, Fixed Glides, Fully Upholstered, Grade 1 Textile	\$1,031	\$4,124	
2	Table	NNO FS13 TM4 TSS2 FG1 LS1	2	Triangle, Solid Surface Tabletop, Fixed Glides, Fully Upholstered, Grade 1 Textile	\$1,062	\$2,124	
3	Seating	NNO FS14 TM0 FG1 LS1	1	Diamond, Fixed Glides, Fully Upholstered, Grade 1 Textile	\$610	\$610	
4	Table	NNO FS14 TM4 TSS2 FG1 LS1	1	Diamond, Solid Surface Tabletop, Fixed Glides, Fully Upholstered, Grade 1 Textile	\$1,506	\$1,506	

TOTAL: \$8,364

Typical 11

Line	Category	Part Number	Qty	Description	Unit Price	Ext Price	
1	Table	NNO FS13 TM3 TL14 FG1 LS1	2	Triangle, Laminate Tabletop, Fixed Glides, Fully Upholstered, Grade 1 Textile	\$562	\$1,124	
2	Seating	NNO FS15 TM0 FG1 LS1	4	Trapezoid, Fixed Glides, Fully Upholstered, Grade 1 Textile	\$1,031	\$4,124	
3	Seating	NNO FS14 TM0 FG1 LS1	1	Diamond, Fixed Glides, Fully Upholstered, Grade 1 Textile	\$610	\$610	
4	Table	NNO FS14 TM3 TL14 FG1 LS1	1	Diamond, Laminate Tabletop, Fixed Glides, Fully Upholstered, Grade 1 Textile	\$806	\$806	

TOTAL: \$6,664

GSA SIN #: 33721

Typical 12

Line	Category	Part Number	Qty	Description	Unit Price	Ext. Price	
1	Seating	NNO FS15 TM0 FG1 LS1	4	Trapezoid, Fixed Glides, Fully Upholstered, Grade 1 Textile	\$1,031	\$4,124	
2	Table	NNO FS13 TM4 TSS2 FG1 LS1	1	Triangle, Solid Surface Tabletop, Fixed Glides, Fully Upholstered, Grade 1 Textile	\$1,062	\$1,062	
3	Seating	NNO FS14 TM0 FG1 LS1	1	Diamond, Fixed Glides, Fully Upholstered, Grade 1 Textile	\$610	\$610	
4	Table	NNO FS14 TM4 TSS2 FG1 LS1	1	Diamond, Solid Surface Tabletop, Fixed Glides, Fully Upholstered, Grade 1 Textile	\$1,506	\$1,506	
5	Seating	NNO FS13 TM0 FG1 LS1	1	Triangle, Fixed Glides, Fully Upholstered, Grade 1 Textile	\$422	\$422	

TOTAL: \$7,724

Typical 13

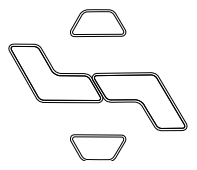
Line	Category	Part Number	Qty	Description	Unit Price	Ext. Price	
1	Seating	NNO FS16 TM0 FG1 LS1	2	Boomerang, Fixed Glides, Fully Upholstered, Grade 1 Textile	\$2,439	\$4,878	
2	Seating	NNO FS15 TM0 FG1 LS1	2	Trapezoid, Fixed Glides, Fully Upholstered, Grade 1 Textile	\$1,031	\$2,062	

TOTAL: \$6,940

Typical 14

Line	Category	Part Number	Qty	Description	Unit Price	Ext. Price	
1	Seating	NNO FS15 TM0 FG1 LS1	4	Trapezoid, Fixed Glides, Fully Upholstered, Grade 1 Textile	\$1,031	\$4,124	
2	Seating	NNO FS14 TM0 FG1 LS1	1	Diamond, Fixed Glides, Fully Upholstered, Grade 1 Textile	\$610	\$610	
3	Table	NNO FS14 TM3 TL13 FG1 LS1	1	Diamond, Laminate Tabletop, Fixed Glides, Fully Upholstered, Grade 1 Textile	\$806	\$806	
4	Table	NNO FS13 TM3 TL13 FG1 LS1	1	Triangle, Laminate Tabletop, Fixed Glides, Fully Upholstered, Grade 1 Textile	\$562	\$562	
5	Seating	NNO FS13 TM0 FG1 LS1	1	Triangle, Fixed Glides, Fully Upholstered, Grade 1 Textile	\$422	\$422	

TOTAL: \$6,524

GSA SIN #: 33721

Typical 15

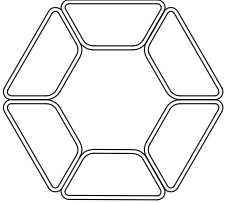
Line	Category	Part Number	Qty	Description	Unit Price	Ext. Price	
1	Seating	NNO FS15 TM0 FG1 LS1	6	Trapezoid, Fixed Glides, Fully Upholstered, Grade 1 Textile	\$1,031	\$6,186	

TOTAL: \$6,186

Typical 16

Line	Category	Part Number	Qty	Description	Unit Price	Ext. Price	
1	Seating	NNO FS15 TM0 FG1 LS1	4	Trapezoid, Fixed Glides, Fully Upholstered, Grade 1 Textile	\$1,031	\$4,124	
2	Seating	NNO FS14 TM0 FG1 LS1	1	Diamond, Fixed Glides, Fully Upholstered, Grade 1 Textile	\$610	\$610	
3	Table	NNO FS14 TM3 TL15 FG1 LS1	1	Diamond, Laminate Tabletop, Fixed Glides, Fully Upholstered, Grade 1 Textile	\$806	\$806	
4	Seating	NNO FS13 TM0 FG1 LS1	2	Trangle, Fixed Glides, Fully Upholstered, Grade 1 Textile	\$422	\$844	

TOTAL: \$6,384

Nano

MODULAR LOUNGE

Easy from every angle.

Meet Nano, our uniquely designed and easy-to-spec modular lounge collection. Featuring a triangle, diamond, trapezoid and boomerang, Nano's geometric shapes make on-the-spot configuration easy and fun. Create a new, one-of-a-kind look every time in thousands of combinations.



Boomerang

Featured Models

TRIANGLE TABLE :: \$619

Triangle with laminate tabletop,
grade 3 textile

TRAPEZOID :: \$1,248

Trapezoid, multi-upholstery, grade
3 textiles

BOOMERANG :: \$2,734

Boomerang, multi-upholstery,
grade 2 chassis, grade 4 seat

Features

- Four shapes for endless configuration possibilities
- Effortless and fun to design
- Reconfigurable on-the-spot to adapt to any space
- Triangle and diamond shapes feature two solid surface and five laminate tabletop options to enhance functionality
- Mobile and easy to move, or make permanent with ganging brackets
- 400 lb weight capacity warranty (per seat position)



Triangle Table

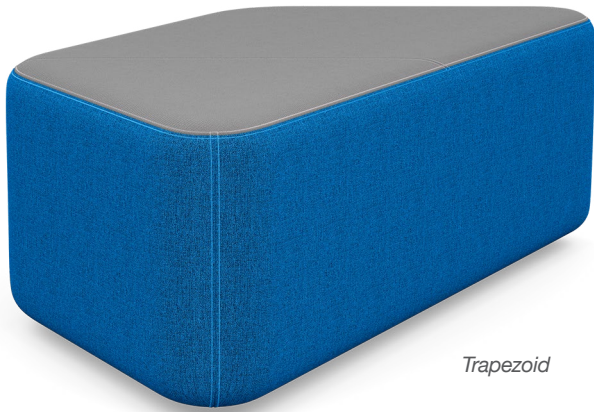

Trapezoid

MODULAR LOUNGE

1. Product

Model	Code	Price	
Triangle	NNO FS13	\$422	
Diamond	NNO FS14	\$610	
Trapezoid	NNO FS15	\$1,031	
Boomerang	NNO FS16	\$2,439	

2. Tabletop

Tabletop Material	Code	Price	
		Triangle	Diamond
No Tabletop	TM0	+ \$0	+ \$0
Laminate	TM3	+ \$140	+ \$196
Solid Surface	TM4	+ \$640	+ \$896
Tabletop Finish		Price	
Laminate Finish			
Field Elm	TL13	+ \$0	
Uptown Walnut	TL14	+ \$0	
Skyline Walnut	TL15	+ \$0	
Frosty White	TL16	+ \$0	
Classic Linen	TL17	+ \$0	
Solid Surface Color			
Designer White	TSS2	+ \$0	
Cameo White	TSS1	+ \$0	

Tabletops available on triangle and diamond models only.

3. Material

Protection		Code		Price			
CAL 133		Triangle	Triangle Table	Diamond	Diamond Table	Trapezoid	Boomerang
CAL 133	UCAL	+ \$88	+ \$88	+ \$175	+ \$175	+ \$262	+ \$494
Cleaning		Code		Price			
Moisture Barrier		Triangle	Triangle Table	Diamond	Diamond Table	Trapezoid	Boomerang
Seat	UM2	+ \$35	N/A	+ \$59	N/A	+ \$118	+ \$177
Fully Upholstered		Code		Price			
Seat and Chassis		Triangle	Triangle Table	Diamond	Diamond Table	Trapezoid	Boomerang
COM	COM	+ \$0	+ \$0	+ \$0	+ \$0	+ \$0	+ \$0
Fabric/Vinyl Grade 1	FG1/VG1	+ \$0	+ \$0	+ \$0	+ \$0	+ \$0	+ \$0
Fabric/Vinyl Grade 2	FG2/VG2	+ \$40	+ \$36	+ \$61	+ \$40	+ \$77	+ \$135
Fabric/Vinyl Grade 3	FG3/VG3	+ \$63	+ \$57	+ \$94	+ \$63	+ \$120	+ \$210
Fabric/Vinyl Grade 4	FG4/VG4	+ \$90	+ \$81	+ \$135	+ \$90	+ \$171	+ \$300
Fabric/Vinyl Grade 5	FG5/VG5	+ \$135	+ \$121	+ \$202	+ \$135	+ \$256	+ \$450
Fabric/Vinyl Grade 6	FG6/VG6	+ \$180	+ \$162	+ \$270	+ \$180	+ \$342	+ \$600
Fabric/Vinyl Grade 7	FG7/VG7	+ \$225	+ \$202	+ \$337	+ \$225	+ \$427	+ \$750
Multi-Upholstery		Code		Price			
		Triangle	Triangle Table	Diamond	Diamond Table	Trapezoid	Boomerang
Multi-Upholstery Upcharge	UMU	+ \$75	N/A	+ \$75	N/A	+ \$75	+ \$75
Seat Only		Triangle	Triangle Table	Diamond	Diamond Table	Trapezoid	Boomerang
COM	COM	+ \$0	N/A	+ \$0	N/A	+ \$0	+ \$0
Fabric/Vinyl Grade 1	FG1/VG1	+ \$0	N/A	+ \$0	N/A	+ \$0	+ \$0
Fabric/Vinyl Grade 2	FG2/VG2	+ \$19	N/A	+ \$34	N/A	+ \$31	+ \$61
Fabric/Vinyl Grade 3	FG3/VG3	+ \$29	N/A	+ \$52	N/A	+ \$48	+ \$94
Fabric/Vinyl Grade 4	FG4/VG4	+ \$42	N/A	+ \$75	N/A	+ \$69	+ \$135
Fabric/Vinyl Grade 5	FG5/VG5	+ \$63	N/A	+ \$112	N/A	+ \$103	+ \$202
Fabric/Vinyl Grade 6	FG6/VG6	+ \$84	N/A	+ \$150	N/A	+ \$138	+ \$270
Fabric/Vinyl Grade 7	FG7/VG7	+ \$105	N/A	+ \$187	N/A	+ \$172	+ \$337
Chassis Only		Triangle	Triangle Table	Diamond	Diamond Table	Trapezoid	Boomerang
COM	COM	+ \$0	N/A	+ \$0	N/A	+ \$0	+ \$0
Fabric/Vinyl Grade 1	FG1/VG1	+ \$0	N/A	+ \$0	N/A	+ \$0	+ \$0
Fabric/Vinyl Grade 2	FG2/VG2	+ \$36	N/A	+ \$40	N/A	+ \$61	+ \$85
Fabric/Vinyl Grade 3	FG3/VG3	+ \$57	N/A	+ \$63	N/A	+ \$94	+ \$132
Fabric/Vinyl Grade 4	FG4/VG4	+ \$81	N/A	+ \$90	N/A	+ \$135	+ \$189
Fabric/Vinyl Grade 5	FG5/VG5	+ \$121	N/A	+ \$135	N/A	+ \$202	+ \$283
Fabric/Vinyl Grade 6	FG6/VG6	+ \$162	N/A	+ \$180	N/A	+ \$270	+ \$378
Fabric/Vinyl Grade 7	FG6/VG7	+ \$202	N/A	+ \$225	N/A	+ \$337	+ \$472

Moisture barrier (UM2) seat is not available with tabletop (TM3/TM4). If different fabrics are selected for the seat and chassis, add the multiple upholstery upcharge as well.

Please reference the Textile Reference Guide for pricing on fabric over grade 7 and leather over grade 3.

4. Glides

Glide Options	Code	Price
Fixed Glides	LS1	+ \$0

5. Options

Accessories	Code	Price
One Ganging Bracket (Attaches to Either Side)	XGV	+ \$52

Trapezoid and boomerang accommodate up to two ganging units on the 52" sides.

6. Packaging

Packaging	Code	Price
Fully Assembled in a Carton	P1	+ \$0

SPECIFICATIONS

Model:	NNO FS13 Triangle	NNO FS14 Diamond	NNO FS15 Trapezoid	NNO FS16 Boomerang
Height (TM0)	17"	17"	17"	17"
Height (TM3/TM4)	17"	17"	—	—
Width	23"	37.5"	52"	81"
Depth	21"	25"	25"	50"
Weight	21 lb	32 lb	45 lb	92 lb
Weight (TM3)	31.5 lb	54.5 lb	—	—
Weight (TM4)	30 lb	51.1 lb	—	—
COM (Fully Upholstered)	2 yd	3 yd	3.5 yd	6.5 yd
COM (Multi-Upholstery)				
Seat	1 yd	1.5 yd	1.5 yd	3 yd
Chassis	2 yd	2 yd	3 yd	4 yd
Weight Capacity Warranty	400 lb	400 lb	800 lb	1200 lb

No tabletop (TM0). Solid surface tabletop (TM4). Laminate tabletop (TM3).

Yardage requirements for COM are for solid and non-directional fabrics. Additional material may be required for larger repeating patterns.

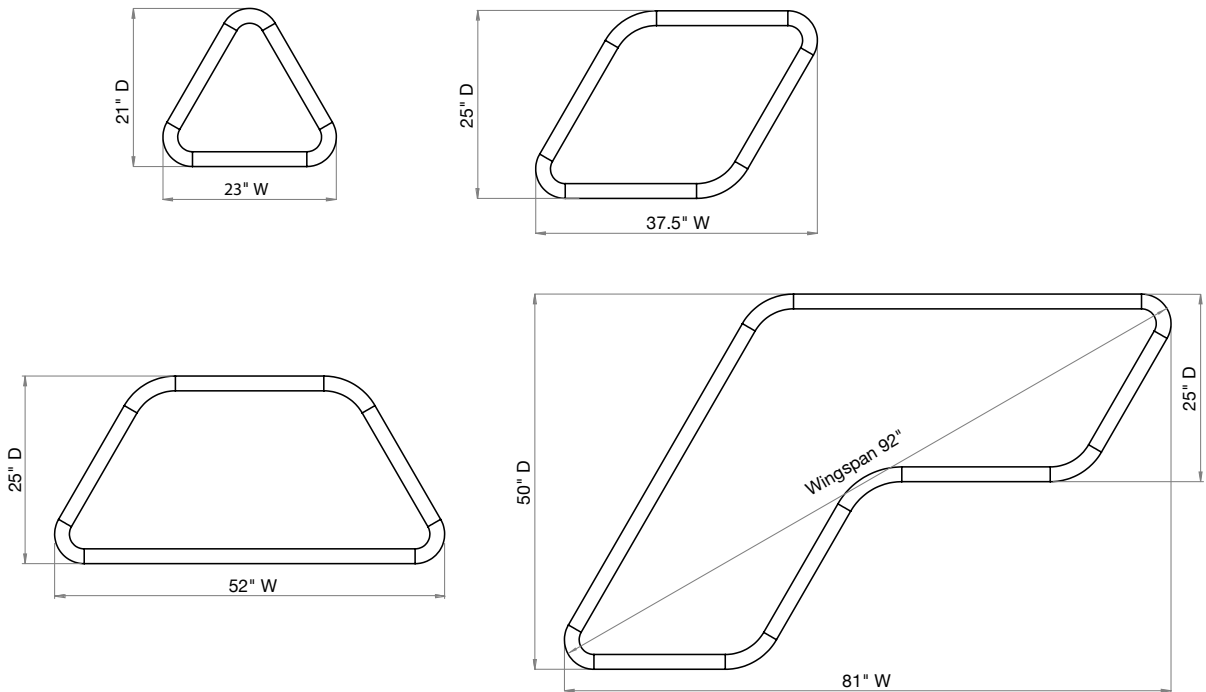

Paséa

MODULAR LOUNGE TYPICALS

Lounge that works.

Paséa features tapered angles and comfort scaling for a lightweight, refined style while promoting an active working posture so that you get our award-winning task chair performance away from your desk.

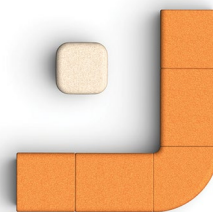
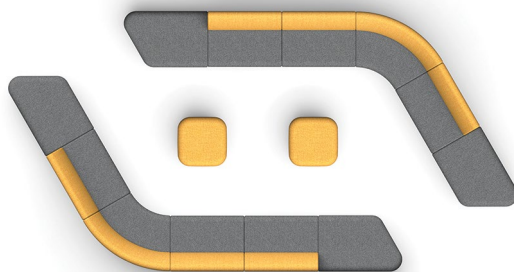
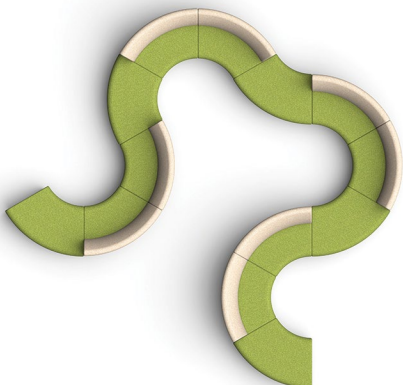
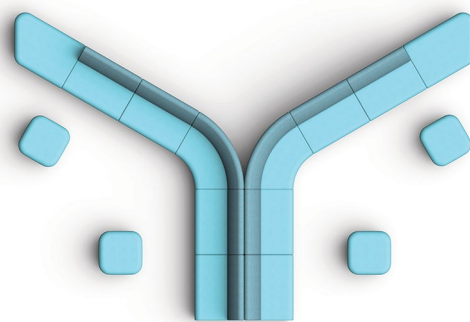
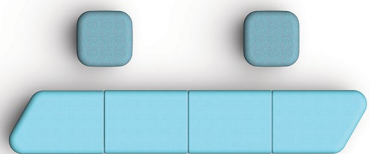
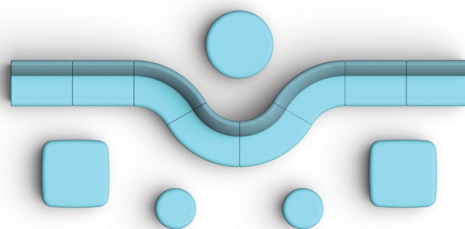
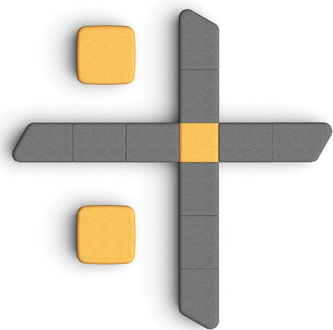

GSA SIN #: 33721

Typical 1

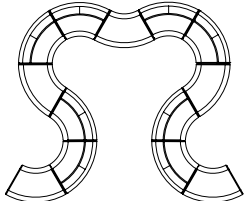
Line	Category	Part Number	Qty	Description	Unit Price	Ext Price	
1	Seating	PAS FS17 SS3	8	120-Degree Inner Seat, Fully Upholstered, Grade 1 Textile	\$2,251	\$18,008	
2	Seating	PAS FS2 BNS6	5	120° Bench, Fully Upholstered, Grade 1 Textile	\$1,688	\$8,440	

TOTAL: \$26,448

Typical 2

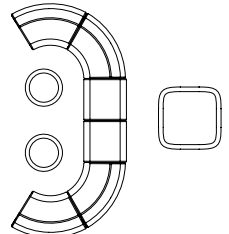
Line	Category	Part Number	Qty	Description	Unit Price	Ext Price	
1	Seating	PAS FS17 SS3	4	120° Inner Seat, Fully Upholstered, Grade 1 Textile	\$2,251	\$9,004	
2	Seating	PAS FS2 BNS1	2	Single Bench, Fully Upholstered, Grade 1 Textile	\$938	\$1,876	
3	Seating	PAS FS1 OS1	2	Mini Round Ottoman, Fully Upholstered, Grade 1 Textile	\$563	\$1,126	
4	Seating	PAS FS1 OS4	1	Large Square Ottoman, Fully Upholstered, Grade 1 Textile	\$1,078	\$1,078	

TOTAL: \$13,084

Typical 3

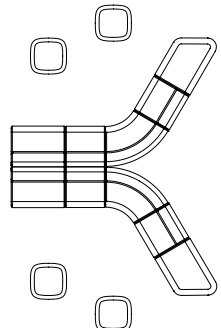
Line	Category	Part Number	Qty	Description	Unit Price	Ext Price	
1	Seating	PAS FS17 SS2	2	1.5 Seat, Fully Upholstered, Grade 1 Textile	\$1,500	\$3,000	
2	Seating	PAS FS17 SS1	4	Single Seat, Fully Upholstered, Grade 1 Textile	\$1,219	\$4,876	
3	Seating	PAS FS17 SS3	2	120° Inner Seat, Fully Upholstered, Grade 1 Textile	\$2,251	\$4,502	
4	Seating	PAS FS2 BNS3	1	Right-Angled End Bench, Fully Upholstered, Grade 1 Textile	\$1,164	\$1,164	
5	Seating	PAS FS2 BNS4	1	Left-Angled End Bench, Fully Upholstered, Grade 1 Textile	\$1,164	\$1,164	
6	Seating	PFA FS1 OS3	4	Mini Square Ottoman, Fully Upholstered, Grade 1 Textile	\$563	\$2,252	

TOTAL: \$16,958

Typical 4

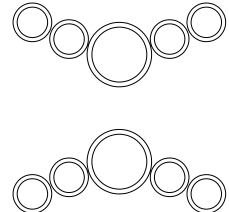
Line	Category	Part Number	Qty	Description	Unit Price	Ext Price	
1	Seating	PAS FS1 OS1	8	Mini Round Ottoman, Fully Upholstered, Grade 1 Textile	\$563	\$4,504	
2	Seating	PAS FS1 OS2	2	Large Round Ottoman, Fully Upholstered, Grade 1 Textile	\$1,078	\$2,156	

TOTAL: \$6,660

GSA SIN #: 33721

Typical 5

Line	Category	Part Number	Qty	Description	Unit Price	Ext Price	
1	Seating	PAS FS1 OS1	2	Mini Round Ottoman, Fully Upholstered, Grade 1 Textile	\$563	\$1,126	
2	Seating	PAS FS1 OS4	2	Large Square Ottoman, Fully Upholstered, Grade 1 Textile	\$1,078	\$2,156	
3	Seating	PAS FS17 SS4	2	120-Degree Outer Seat, Fully Upholstered, Grade 1 Textile	\$2,251	\$4,502	
4	Seating	PAS FS17 SS3	2	120-Degree Inner Seat, Fully Upholstered, Grade 1 Textile	\$2,251	\$4,502	
5	Seating	PAS FS17 SS2	4	1.5 Seat, Fully Upholstered, Grade 1 Textile	\$1,500	\$6,000	
6	Seating	PAS FS1 OS2	1	Large Round Ottoman, Fully Upholstered, Grade 1 Textile	\$1,078	\$1,078	

TOTAL: \$19,364

Typical 6

Line	Category	Part Number	Qty	Description	Unit Price	Ext Price	
1	Seating	PAS FS2 BNS1	2	Single Bench, Fully Upholstered, Grade 1 Textile	\$938	\$1,876	
2	Seating	PAS FS2 BNS2	2	1.5 Bench, Fully Upholstered, Grade 1 Textile	\$1,219	\$2,438	
3	Seating	PAS FS2 BNS5	1	90-Degree Corner Bench, Fully Upholstered, Grade 1 Textile	\$1,688	\$1,688	
4	Seating	PAS FS1 OS3	1	Mini Square Ottoman, Fully Upholstered, Grade 1 Textile	\$563	\$563	

TOTAL: \$6,565

Typical 7

Line	Category	Part Number	Qty	Description	Unit Price	Ext Price	
1	Seating	PAS FS17 SS3	6	120-Degree Inner Seat, Fully Upholstered, Grade 1 Textile	\$2,251	\$13,506	
2	Seating	PAS FS1 OS1	2	Mini Round Ottoman, Fully Upholstered, Grade 1 Textile	\$563	\$1,126	

TOTAL: \$14,632

GSA SIN #: 33721

Typical 8

Line	Category	Part Number	Qty	Description	Unit Price	Ext Price	
1	Seating	PAS FS2 BNS2	4	1.5 Bench, Fully Upholstered, Grade 1 Textile	\$1,219	\$4,876	
2	Seating	PAS FS17 SS3	6	120-Degree Inner Seat, Fully Upholstered, Grade 1 Textile	\$2,251	\$13,506	
3	Seating	PAS FS1 OS1	2	Mini Round Ottoman, Fully Upholstered, Grade 1 Textile	\$563	\$1,126	
						TOTAL: \$19,508	

Typical 9

Line	Category	Part Number	Qty	Description	Unit Price	Ext Price	
1	Seating	PAS FS17 SS3	4	120-Degree Inner Seat, Fully Upholstered, Grade 1 Textile	\$2,251	\$9,004	
2	Seating	PAS FS2 BNS6	2	120-Degree Bench, Fully Upholstered, Grade 1 Textile	\$1,688	\$3,376	
3	Seating	PAS FS1 OS1	2	Mini Round Ottoman, Fully Upholstered, Grade 1 Textile	\$563	\$1,126	
						TOTAL: \$13,506	

Typical 10

Line	Category	Part Number	Qty	Description	Unit Price	Ext Price	
1	Seating	PAS FS17 SS2	8	1.5 Seat, Fully Upholstered, Grade 1 Textile	\$1,500	\$12,000	
2	Seating	PAS FS2 BNS5	2	90-Degree Corner Bench, Fully Upholstered, Grade 1 Textile	\$1,688	\$3,376	
3	Seating	PAS FS1 OS4	2	Large Square Ottoman, Fully Upholstered, Grade 1 Textile	\$1,078	\$2,156	
						TOTAL: \$17,532	

GSA SIN #: 33721

Typical 11

Line	Category	Part Number	Qty	Description	Unit Price	Ext. Price	
1	Seating	PAS FS1 OS1	3	Mini Round Ottoman, Fully Upholstered, Grade 1 Textile	\$563	\$1,689	
2	Seating	PAS FS2 BNS6	5	120-Degree Bench, Fully Upholstered, Grade 1 Textile	\$1,688	\$8,440	
3	Seating	PAS FS1 OS3	2	Mini Square Ottoman, Fully Upholstered, Grade 1 Textile	\$563	\$1,126	

TOTAL: \$11,255

Typical 12

Line	Category	Part Number	Qty	Description	Unit Price	Ext. Price	
1	Seating	PAS FS1 OS3	4	Mini Square Ottoman, Fully Upholstered, Grade 1 Textile	\$563	\$2,252	
2	Seating	PAS FS2 BNS4	4	Left-Angled End Bench, Fully Upholstered, Grade 1 Textile	\$1,164	\$4,656	
3	Seating	PAS FS2 BNS2	2	1.5 Bench, Fully Upholstered, Grade 1 Textile	\$1,219	\$2,438	

TOTAL: \$9,346

Typical 13

Line	Category	Part Number	Qty	Description	Unit Price	Ext. Price	
1	Seating	PAS FS1 OS1	3	Mini Round Ottoman, Fully Upholstered, Grade 1 Textile	\$563	\$1,689	
2	Seating	PAS FS17 SS4	3	120-Degree Outer Seat, Fully Upholstered, Grade 1 Textile	\$2,251	\$6,753	

TOTAL: \$8,442

Paséa

MODULAR LOUNGE

Lounge that works.

Work, wait, welcome or wind down, experience the freedom to do anything in a single solution. The tapered base, comfort-scaled seat and built-in backrest with lumbar curve promote an active working posture and lasting support. Rethink what a lounge collection can (and should) be with Paséa.



Single Seat

Featured Models

SINGLE BENCH :: \$1,003

Single seat bench, fully upholstered, grade 3 seat textile

SINGLE SEAT :: \$1,413

Single seat, multi-upholstery, grade 3 seat and back textile

120° SEAT :: \$2,578

120° inner seat, multi-upholstery, grade 4 seat and back textile

Features



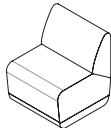
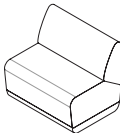
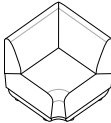
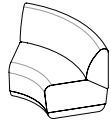
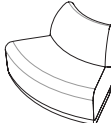

- Choose from a wide variety of benches and seats
- Build using right- or left-angled, 90- or 120-degree pieces
- Configure rectilinear and curvilinear setups with modular seats and benches
- Promote an active working posture with built-in lumbar curve and comfort-scaled seat
- Blend with any environment using graphite or slate base colors

- Add brilliant diamond-cut details with multi-upholstery
- Provide extra convenience with power options
- Adjustable glides standard on modular lounge models
- 400 lb weight capacity warranty (per seat)

1. Product

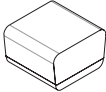
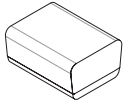
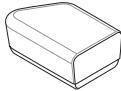
Model	Code	Price	
Seat			
Single Seat	PAS FS17 SS1	\$1,219	
1.5 Seat	PAS FS17 SS2	\$1,500	
90-Degree Corner Seat	PAS FS17 SS5	\$1,856	
120-Degree Inner Seat	PAS FS17 SS3	\$2,251	
120-Degree Outer Seat	PAS FS17 SS4	\$2,251	

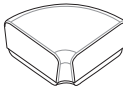

1. Product (Cont.)

Model	Code	Price	
Bench			
Single Bench	PAS FS2 BNS1	\$938	
1.5 Bench	PAS FS2 BNS2	\$1,219	
Right-Angled End Bench	PAS FS2 BNS3	\$1,164	
Left-Angled End Bench	PAS FS2 BNS4	\$1,164	
90-Degree Corner Bench	PAS FS2 BNS5	\$1,688	
120-Degree Bench	PAS FS2 BNS6	\$1,688	

2. Base



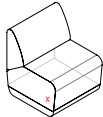
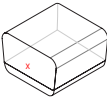
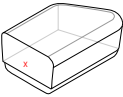
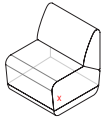
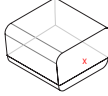
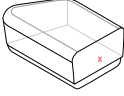
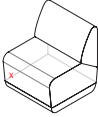
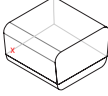

Base Finish	Code	Price
Graphite	LBC2	+ \$0
Slate	LBC3	+ \$0

3. Power



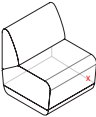
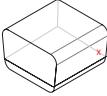

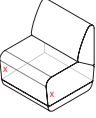
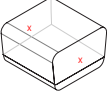
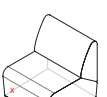
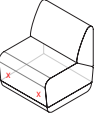
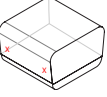

Power Location	Code	Price	
Right-Hand, Side of Unit			
AC/110V	PSR	+ \$125	
Dual USB	PSR	+ \$175	
AC/110V and Dual USB	PSR	+ \$300	
Left-Hand, Side of Unit			
AC/110V	PSL	+ \$125	
Dual USB	PSL	+ \$175	
AC/110V and Dual USB	PSL	+ \$300	
Right-Hand, Front of Unit			
AC/110V	PFR	+ \$125	
Dual USB	PFR	+ \$175	
AC/110V and Dual USB	PFR	+ \$300	

MODULAR LOUNGE SEATING

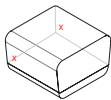
3. Power (Cont.)

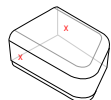
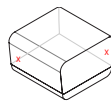
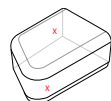

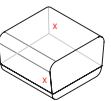

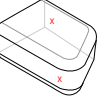
Power Location	Code	Price	
Left-Hand, Front of Unit			
AC/110V	PFL	+ \$125	
Dual USB	PFL	+ \$175	
AC/110V and Dual USB	PFL	+ \$300	
Both Hands, Side of Unit			
AC/110V	PSB	+ \$250	
Dual USB	PSB	+ \$350	
AC/110V and Dual USB	PSB	+ \$600	
Both Hands, Front of Unit			
AC/110V	PFB	+ \$250	
Dual USB	PFB	+ \$350	
AC/110V and Dual USB	PFB	+ \$600	

3. Power (Cont.)

Power Location	Code	Price	
One-Hand, 1 Front and 1 Back			
AC/110V	PBRL	+\$250	
Dual USB	PBRL	+\$350	
AC/110V and Dual USB	PBRL	+\$600	
Both Hands (Right), 1 Front and 1 Back			
AC/110V	PBR	+\$250	
Dual USB	PBR	+\$350	
AC/110V and Dual USB	PBR	+\$600	
Both Hands (Left), 1 Front and 1 Back			
AC/110V	PBL	+\$250	
Dual USB	PBL	+\$350	
AC/110V and Dual USB	PBL	+\$600	

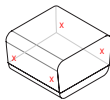
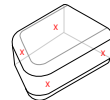
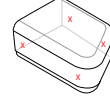
MODULAR LOUNGE SEATING

3. Power (Cont.)

Power Location	Code	Price	
Both Hands, 2 Front and Two Back			
AC/110V	PBB	+\$500	
Dual USB	PBB	+\$700	
AC/110V and Dual USB	PBB	+\$1,200	
Power Type	Code	Price	
AC/110V and Dual USB	PT2	Priced by Number of Units and Location	 
Dual USB	PT3	Priced by Number of Units and Location	
AC/110V	PT4	Priced by Number of Units and Location	

Power is storm colored. Power not available on 120-Degree models (FS17 SS3, FS17 SS4, FS2 BNS6) or 90-degree models (FS17 SS5, FS2 BNS5).

4. Material

Protection: CAL 133	Code	Price	
Single Seat	UCAL	+\$262	
1.5 Seat	UCAL	+\$393	
90-Degree Corner Seat	UCAL	+\$377	
120-Degree Seat	UCAL	+\$377	
Single Bench	UCAL	+\$88	
1.5 Bench	UCAL	+\$175	
Angled Bench	UCAL	+\$175	
90-Degree Bench	UCAL	+\$175	
120-Degree Bench	UCAL	+\$175	

4. Material (Cont.)

Cleaning	Code	Price
Single Seat		
Moisture Barrier Seat	UM2	+ \$59
Moisture Barrier Back	UM1	+ \$59
Moisture Barrier Back and Seat	UM3	+ \$118
1.5 Seat		
Moisture Barrier Seat	UM2	+ \$89
Moisture Barrier Back	UM1	+ \$89
Moisture Barrier Back and Seat	UM3	+ \$177
90-Degree Corner Seat		
Moisture Barrier Seat	UM2	+ \$118
Moisture Barrier Back	UM1	+ \$118
Moisture Barrier Back and Seat	UM3	+ \$236
120-Degree Seat (Inner or Outer)		
Moisture Barrier Seat	UM2	+ \$118
Moisture Barrier Back	UM1	+ \$118
Moisture Barrier Back and Seat	UM3	+ \$236
Single Bench		
Moisture Barrier Seat	UM2	+ \$59
1.5 Bench or Angled Bench		
Moisture Barrier Seat	UM2	+ \$118
90-Degree Bench or 120-Degree Bench		
Moisture Barrier Seat	UM2	+ \$177
Fully Upholstered	Code	Price
Single Seat		
COM	COM	+ \$0
Fabric/Vinyl Grade 1	FG1/VG1	+ \$0
Fabric/Vinyl Grade 2	FG2/VG2	+ \$65
Fabric/Vinyl Grade 3	FG3/VG3	+ \$101
Fabric/Vinyl Grade 4	FG4/VG4	+ \$144
Fabric/Vinyl Grade 5	FG5/VG5	+ \$216
Fabric/Vinyl Grade 6	FG6/VG6	+ \$288
Fabric/Vinyl Grade 7	FG7/VG7	+ \$360

MODULAR LOUNGE SEATING

4. Material (Cont.)

Fully Upholstered	Code	Price
1.5 Seat		
COM	COM	+ \$0
Fabric/Vinyl Grade 1	FG1/VG1	+ \$0
Fabric/Vinyl Grade 2	FG2/VG2	+ \$86
Fabric/Vinyl Grade 3	FG3/VG3	+ \$134
Fabric/Vinyl Grade 4	FG4/VG4	+ \$192
Fabric/Vinyl Grade 5	FG5/VG5	+ \$288
Fabric/Vinyl Grade 6	FG6/VG6	+ \$384
Fabric/Vinyl Grade 7	FG7/VG7	+ \$480
90-Degree Corner Seat		
COM	COM	+ \$0
Fabric/Vinyl Grade 1	FG1/VG1	+ \$0
Fabric/Vinyl Grade 2	FG2/VG2	+ \$113
Fabric/Vinyl Grade 3	FG3/VG3	+ \$176
Fabric/Vinyl Grade 4	FG4/VG4	+ \$252
Fabric/Vinyl Grade 5	FG5/VG5	+ \$378
Fabric/Vinyl Grade 6	FG6/VG6	+ \$504
Fabric/Vinyl Grade 7	FG7/VG7	+ \$630
120-Degree Seat		
COM	COM	+ \$0
Fabric/Vinyl Grade 1	FG1/VG1	+ \$0
Fabric/Vinyl Grade 2	FG2/VG2	+ \$94
Fabric/Vinyl Grade 3	FG3/VG3	+ \$147
Fabric/Vinyl Grade 4	FG4/VG4	+ \$210
Fabric/Vinyl Grade 5	FG5/VG5	+ \$315
Fabric/Vinyl Grade 6	FG6/VG6	+ \$420
Fabric/Vinyl Grade 7	FG7/VG7	+ \$525
Single Seat Bench		
COM	COM	+ \$0
Fabric/Vinyl Grade 1	FG1/VG1	+ \$0
Fabric/Vinyl Grade 2	FG2/VG2	+ \$43
Fabric/Vinyl Grade 3	FG3/VG3	+ \$67
Fabric/Vinyl Grade 4	FG4/VG4	+ \$96
Fabric/Vinyl Grade 5	FG5/VG5	+ \$144
Fabric/Vinyl Grade 6	FG6/VG6	+ \$192
Fabric/Vinyl Grade 7	FG7/VG7	+ \$240

4. Material (Cont.)

Fully Upholstered	Code	Price
1.5 Seat Bench		
COM	COM	+ \$0
Fabric/Vinyl Grade 1	FG1/VG1	+ \$0
Fabric/Vinyl Grade 2	FG2/VG2	+ \$54
Fabric/Vinyl Grade 3	FG3/VG3	+ \$84
Fabric/Vinyl Grade 4	FG4/VG4	+ \$120
Fabric/Vinyl Grade 5	FG5/VG5	+ \$180
Fabric/Vinyl Grade 6	FG6/VG6	+ \$240
Fabric/Vinyl Grade 7	FG7/VG7	+ \$300
90-Degree Corner Bench		
COM	COM	+ \$0
Fabric/Vinyl Grade 1	FG1/VG1	+ \$0
Fabric/Vinyl Grade 2	FG2/VG2	+ \$54
Fabric/Vinyl Grade 3	FG3/VG3	+ \$84
Fabric/Vinyl Grade 4	FG4/VG4	+ \$120
Fabric/Vinyl Grade 5	FG5/VG5	+ \$180
Fabric/Vinyl Grade 6	FG6/VG6	+ \$240
Fabric/Vinyl Grade 7	FG7/VG7	+ \$300
120-Degree Seat Bench		
COM	COM	+ \$0
Fabric/Vinyl Grade 1	FG1/VG1	+ \$0
Fabric/Vinyl Grade 2	FG2/VG2	+ \$54
Fabric/Vinyl Grade 3	FG3/VG3	+ \$84
Fabric/Vinyl Grade 4	FG4/VG4	+ \$120
Fabric/Vinyl Grade 5	FG5/VG5	+ \$180
Fabric/Vinyl Grade 6	FG6/VG6	+ \$240
Fabric/Vinyl Grade 7	FG7/VG7	+ \$300
Angled End Bench		
COM	COM	+ \$0
Fabric/Vinyl Grade 1	FG1/VG1	+ \$0
Fabric/Vinyl Grade 2	FG2/VG2	+ \$54
Fabric/Vinyl Grade 3	FG3/VG3	+ \$84
Fabric/Vinyl Grade 4	FG4/VG4	+ \$120
Fabric/Vinyl Grade 5	FG5/VG5	+ \$180
Fabric/Vinyl Grade 6	FG6/VG6	+ \$240
Fabric/Vinyl Grade 7	FG7/VG7	+ \$300

MODULAR LOUNGE SEATING

4. Material (Cont.)

Multi-Upholstery	Code	Price	
Multi-Upholstery Upcharge			
Multi-Upholstery Upcharge	UMU	+ \$75	
Single Seat		Seat Only	Back Only
COM	COM	+ \$0	+ \$0
Fabric/Vinyl Grade 1	FG1/VG1	+ \$0	+ \$0
Fabric/Vinyl Grade 2	FG2/VG2	+ \$43	+ \$34
Fabric/Vinyl Grade 3	FG3/VG3	+ \$67	+ \$52
Fabric/Vinyl Grade 4	FG4/VG4	+ \$96	+ \$75
Fabric/Vinyl Grade 5	FG5/VG5	+ \$144	+ \$112
Fabric/Vinyl Grade 6	FG6/VG6	+ \$192	+ \$150
Fabric/Vinyl Grade 7	FG7/VG7	+ \$240	+ \$187
1.5 Seat		Seat Only	Back Only
COM	COM	+ \$0	+ \$0
Fabric/Vinyl Grade 1	FG1/VG1	+ \$0	+ \$0
Fabric/Vinyl Grade 2	FG2/VG2	+ \$54	+ \$38
Fabric/Vinyl Grade 3	FG3/VG3	+ \$84	+ \$59
Fabric/Vinyl Grade 4	FG4/VG4	+ \$120	+ \$84
Fabric/Vinyl Grade 5	FG5/VG5	+ \$180	+ \$126
Fabric/Vinyl Grade 6	FG6/VG6	+ \$240	+ \$168
Fabric/Vinyl Grade 7	FG7/VG7	+ \$300	+ \$210



120-Degree Inner Seat

4. Material (Cont.)

Multi-Upholstery	Code	Price	
		Seat Only	Back Only
90-Degree Seat			
COM	COM	+ \$0	+ \$0
Fabric/Vinyl Grade 1	FG1/VG1	+ \$0	+ \$0
Fabric/Vinyl Grade 2	FG2/VG2	+ \$59	+ \$65
Fabric/Vinyl Grade 3	FG3/VG3	+ \$92	+ \$101
Fabric/Vinyl Grade 4	FG4/VG4	+ \$132	+ \$144
Fabric/Vinyl Grade 5	FG5/VG5	+ \$198	+ \$216
Fabric/Vinyl Grade 6	FG6/VG6	+ \$264	+ \$288
Fabric/Vinyl Grade 7	FG7/VG7	+ \$330	+ \$360
120-Degree Seat			
COM	COM	+ \$0	+ \$0
Fabric/Vinyl Grade 1	FG1/VG1	+ \$0	+ \$0
Fabric/Vinyl Grade 2	FG2/VG2	+\$59	+\$54
Fabric/Vinyl Grade 3	FG3/VG3	+\$92	+\$84
Fabric/Vinyl Grade 4	FG4/VG4	+\$132	+\$120
Fabric/Vinyl Grade 5	FG5/VG5	+\$198	+\$180
Fabric/Vinyl Grade 6	FG6/VG6	+\$264	+\$240
Fabric/Vinyl Grade 7	FG7/VG7	+\$330	+\$300

If different fabrics are selected for the seat and back, add the multiple upholstery upcharge as well, even if the fabrics are the same grade.

Please reference the *Textile Reference Guide* for pricing on fabric over grade 7 and leather over grade 3.

5. Options

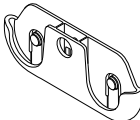
Accessories	Code	Price	
Two Ganging Brackets to Connect to Left-Side or Right-Side	XGV	+ \$52	

One XGV set connects one side of a unit. Order two sets if you need the unit connected on both sides.

6. Packaging

Packaging	Code	Price	
Fully Assembled in Carton	P1	+ \$0	

MODULAR LOUNGE SEATING

SINGLE SEAT AND BENCH SPECIFICATIONS

Model:	PAS FS17 SS1 Single Seat	PAS FS2 BNS1 Single Bench
Height	31.5"	17.5"
Width	27"	27"
Depth	27"	27"
Seat Depth	17.9"	27"
Seat Height	17.5"	17.5"
Back Height	14.5"	N/A
Weight	64.5 lb	49 lb
COM (Fully Upholstered)	3 yd	2 yd
COM (Multi-Upholstery)		
Seat Only	2 yd	N/A
Back Only	1.56 yd	
Weight Capacity Warranty	400 lb	400 lb

1.5 SEAT AND BENCH SPECIFICATIONS

Model:	PAS FS17 SS2 1.5 Seat	PAS FS2 BNS2 1.5 Bench
Height	31.5	17.5"
Width	36"	36"
Depth	27"	27"
Seat Depth	17.9"	27"
Seat Height	17.5"	17.5"
Back Height	14.5"	N/A
Weight	82.5 lb	58.5 lb
COM (Fully Upholstered)	4 yd	2.5 yd
COM (Multi-Upholstery)		
Seat Only	2.5 yd	N/A
Back Only	1.75 yd	
Weight Capacity Warranty	800 lb	800 lb

MODULAR LOUNGE SEATING

90-DEGREE SEAT AND BENCH SPECIFICATIONS

Model:	PAS FS17 SS5 90-Degree Corner Seat	PAS FS2 BNS5 90-Degree Corner Bench
Height	31.5"	17.5"
Width	30"	42.5"
Depth	30"	27"
Seat Depth	17.9"	27"
Seat Height	17.5"	17.5"
Back Height	14.5"	N/A
Weight	86 lb	47 lb
COM (Fully Upholstered)	5.25 yd	2.5 yd
COM (Multi-Upholstery)		
Seat Only	2.75 yd	N/A
Back Only	3 yd	
Weight Capacity Warranty	400 lb	400 lb

ANGLED BENCH SPECIFICATIONS

	PAS FS2 BNS3 Right-Angled	PAS FS2 BNS4 Left-Angled
Height	17.5"	17.5"
Width	47.5"	47.5"
Depth	27"	27"
Seat Depth	27"	27"
Seat Height	17.5"	17.5"
Weight	61.5 lb	61.5 lb
COM (Single Upholstery)	2.5 yd	2.5 yd
Weight Capacity	800 lb	800 lb

120-DEGREE SEAT AND BENCH SPECIFICATIONS

Model:	PAS FS17 SS3 120-Degree Inner Seat	PAS FS17 SS4 120-Degree Outer Seat	PAS FS2 BNS6 120-Degree Bench
Height	31.5"	31.5"	17.5"
Width	47.5"	47.5"	47.5"
Depth	27"	27"	27"
Seat Depth	17.9"	17.9"	27"
Seat Height	17.5"	17.5"	17.5"
Back Height	14.5"	14.5"	N/A
Weight	87.5 lb	78 lb	63 lb
COM (Fully Upholstered)	4.38 yd	4.38 yd	2.5 yd
COM (Multi-Upholstery)			
Seat Only	2.75 yd	2.75 yd	N/A
Back Only	2.5 yd	2.5 yd	
Weight Capacity Warranty	800 lb	800 lb	800 lb



Single Seat Bench

Paséa

TABLES AND OTTOMANS

Lounge that works.

Whether it's to rest your bag or your body, the modularity of the Paséa collection makes it easy to ensure there's always an extra place. This comprehensive collection includes a variety of ottomans and tables that pair perfectly with gapless seats and benches.

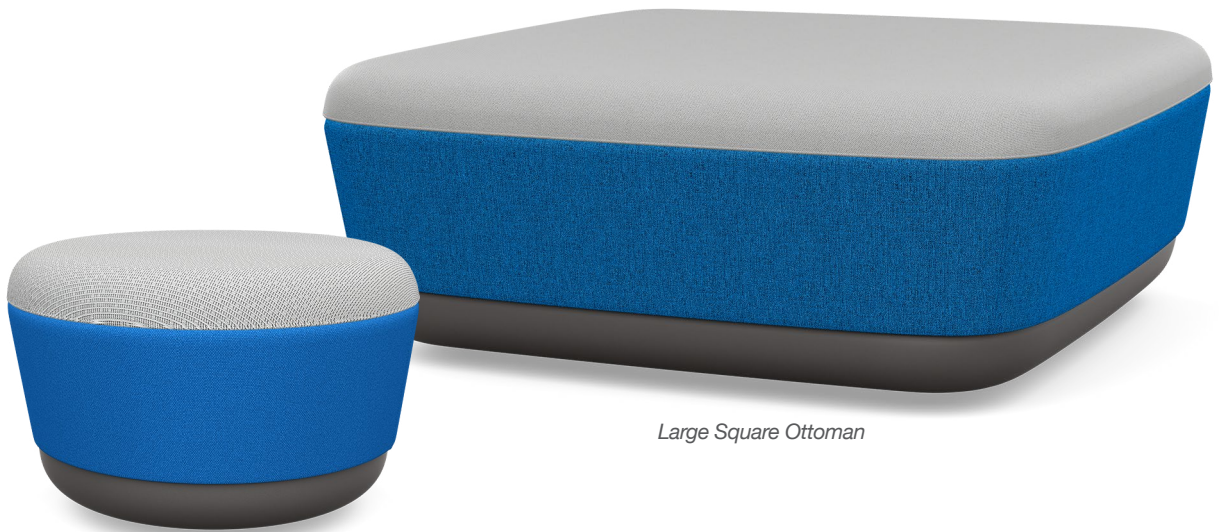

Mini Round Ottoman

Large Square Ottoman

Featured Models

MINI ROUND OTTOMAN :: \$638

Mini round ottoman, multi-upholstery, grade 1 textiles

MINI ROUND OTTOMAN TABLE :: \$939

Mini round ottoman, grade 4 textile, laminate tabletop





LARGE SQUARE OTTOMAN :: \$1,291

Large square ottoman, multi-upholstery, grade 4 seat textile grade 3 chassis textile

Features

- Choose from an assortment of large and mini ottoman and table options, including square and round pieces
- Blend with any environment using graphite or slate base colors
- Tabletops come in five attractive laminate finishes
- Adjustable glides standard on large ottomans
- Fixed multi-surface glides standard on easy-to-move mini ottomans
- 400 lb weight capacity warranty (per seat)

1. Product

Model	Code	Price	
Mini Round Ottoman	PAS FS1 OS1	\$563	
Mini Square Ottoman	PAS FS1 OS3	\$563	
Large Round Ottoman	PAS FS1 OS2	\$1,078	
Large Square Ottoman	PAS FS1 OS4	\$1,078	

2. Base

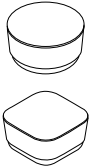
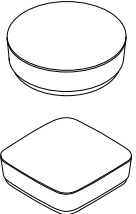

Base Finish	Code	Price
Graphite	LBC2	+ \$0
Slate	LBC3	+ \$0

3. Tabletop

Tabletop Material	Code	Price	
No Tabletop	TM0	+ \$0	
Mini Round or Square Laminate Top	TM3	+ \$328	
Large Round or Square Laminate Top	TM3	+ \$722	

Tabletop Finish	Code	Price
Field Elm	TL13	+ \$0
Uptown Walnut	TL14	+ \$0
Skyline Walnut	TL15	+ \$0
Frosty White	TL16	+ \$0
Classic Linen	TL17	+ \$0

4. Power

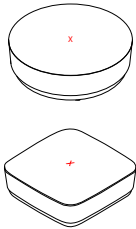
Power Type	Code	Price	
AC/110V and Dual USB	PT2	+ \$300	
Dual USB	PT3	+ \$175	
AC/110V	PT4	+ \$125	
Power Location	Code	Price	
Top Center	PT4	+ \$125	

Power is only available on large ottomans with tabletops. Power is located in the center of the laminate top.

5. Material

Protection	Code	Price
CAL 133		
Mini Ottoman	UCAL	+ \$88
Large Ottoman	UCAL	+ \$262
Cleaning	Code	Price
Moisture Barrier Seat		
Mini Ottoman	UM2	+ \$35
Large Ottoman	UM2	+ \$177
Fully Upholstered	Code	Price
Mini Round Ottoman		
COM	COM	+ \$0
Fabric/Vinyl Grade 1	FG1/VG1	+ \$0
Fabric/Vinyl Grade 2	FG2/VG2	+ \$38
Fabric/Vinyl Grade 3	FG3/VG3	+ \$59
Fabric/Vinyl Grade 4	FG4/VG4	+ \$84
Fabric/Vinyl Grade 5	FG5/VG5	+ \$126
Fabric/Vinyl Grade 6	FG6/VG6	+ \$168
Fabric/Vinyl Grade 7	FG7/VG7	+ \$210
Mini Square Ottoman		
COM	COM	+ \$0
Fabric/Vinyl Grade 1	FG1/VG1	+ \$0
Fabric/Vinyl Grade 2	FG2/VG2	+ \$40
Fabric/Vinyl Grade 3	FG3/VG3	+ \$63
Fabric/Vinyl Grade 4	FG4/VG4	+ \$90
Fabric/Vinyl Grade 5	FG5/VG5	+ \$135
Fabric/Vinyl Grade 6	FG6/VG6	+ \$180
Fabric/Vinyl Grade 7	FG7/VG7	+ \$225
Mini Round or Mini Square Ottoman With Tabletop		
COM	COM	+ \$0
Fabric/Vinyl Grade 1	FG1/VG1	+ \$0
Fabric/Vinyl Grade 2	FG2/VG2	+ \$22
Fabric/Vinyl Grade 3	FG3/VG3	+ \$34
Fabric/Vinyl Grade 4	FG4/VG4	+ \$48
Fabric/Vinyl Grade 5	FG5/VG5	+ \$72
Fabric/Vinyl Grade 6	FG6/VG6	+ \$96
Fabric/Vinyl Grade 7	FG7/VG7	+ \$120

Cleaning and protection options are not applicable on ottomans with laminate tops.

5. Material (Cont.)

Fully Upholstered	Code	Price	
Large Round Ottoman			
COM	COM	+ \$0	
Fabric/Vinyl Grade 1	FG1/VG1	+ \$0	
Fabric/Vinyl Grade 2	FG2/VG2	+ \$72	
Fabric/Vinyl Grade 3	FG3/VG3	+ \$112	
Fabric/Vinyl Grade 4	FG4/VG4	+ \$161	
Fabric/Vinyl Grade 5	FG5/VG5	+ \$241	
Fabric/Vinyl Grade 6	FG6/VG6	+ \$322	
Fabric/Vinyl Grade 7	FG7/VG7	+ \$402	
Large Square Ottoman			
COM	COM	+ \$0	
Fabric/Vinyl Grade 1	FG1/VG1	+ \$0	
Fabric/Vinyl Grade 2	FG2/VG2	+ \$74	
Fabric/Vinyl Grade 3	FG3/VG3	+ \$115	
Fabric/Vinyl Grade 4	FG4/VG4	+ \$165	
Fabric/Vinyl Grade 5	FG5/VG5	+ \$247	
Fabric/Vinyl Grade 6	FG6/VG6	+ \$330	
Fabric/Vinyl Grade 7	FG7/VG7	+ \$412	
Large Round or Square Ottoman With Tabletop			
COM	COM	+ \$0	
Fabric/Vinyl Grade 1	FG1/VG1	+ \$0	
Fabric/Vinyl Grade 2	FG2/VG2	+ \$40	
Fabric/Vinyl Grade 3	FG3/VG3	+ \$63	
Fabric/Vinyl Grade 4	FG4/VG4	+ \$90	
Fabric/Vinyl Grade 5	FG5/VG5	+ \$135	
Fabric/Vinyl Grade 6	FG6/VG6	+ \$180	
Fabric/Vinyl Grade 7	FG7/VG7	+ \$225	
Multi-Upholstery	Code	Price	
Multi-Upholstery Upcharge	UMU	+ \$75	
Mini Round or Square Ottoman		Seat	Chassis
COM	COM	+ \$0	+ \$0
Fabric/Vinyl Grade 1	FG1/VG1	+ \$0	+ \$0
Fabric/Vinyl Grade 2	FG2/VG2	+ \$22	+ \$22
Fabric/Vinyl Grade 3	FG3/VG3	+ \$34	+ \$34
Fabric/Vinyl Grade 4	FG4/VG4	+ \$48	+ \$48
Fabric/Vinyl Grade 5	FG5/VG5	+ \$72	+ \$72
Fabric/Vinyl Grade 6	FG6/VG6	+ \$96	+ \$96
Fabric/Vinyl Grade 7	FG7/VG7	+ \$120	+ \$120

5. Material (Cont.)

Multi-Upholstery	Code	Price	
Large Round or Square Ottoman		Seat	Chassis
COM	COM	+ \$0	+ \$0
Fabric/Vinyl Grade 1	FG1/VG1	+ \$0	+ \$0
Fabric/Vinyl Grade 2	FG2/VG2	+ \$34	+ \$40
Fabric/Vinyl Grade 3	FG3/VG3	+ \$52	+ \$63
Fabric/Vinyl Grade 4	FG4/VG4	+ \$75	+ \$90
Fabric/Vinyl Grade 5	FG5/VG5	+ \$112	+ \$135
Fabric/Vinyl Grade 6	FG6/VG6	+ \$150	+ \$180
Fabric/Vinyl Grade 7	FG7/VG7	+ \$187	+ \$225

Ottomans with tabletops are only available fully upholstered.

If different fabrics are selected for the seat and chassis, add the multi-upholstery upcharge as well, even if the fabrics are the same grade

Please reference the Textile Reference Guide for pricing on fabric over grade 7.

6. Packaging

Packaging	Code	Price
Fully Assembled in Carton	P1	+ \$0

SPECIFICATIONS: MINI OTTOMAN

Model:	PAS FS1 OS1 Mini Round Ottoman	PAS FS1 OS3 Mini Square Ottoman
Height	17.5"	17.5"
Width	24"	24"
Depth	24"	24"
Seat Depth	24"	24"
Seat Height	17.5"	17.5"
Weight	34 lb	43.5 lb
COM (Fully Upholstered)	1.75 yd	1.88 yd
COM (Multi-Upholstery)		
Seat Top	1 yd	1 yd
Chassis	1 yd	1 yd
Weight Capacity	400 lb	400 lb
Warranty		



Mini Round Table

TABLES AND OTTOMANS

SPECIFICATIONS: LARGE OTTOMAN

Model:	PAS FS1 OS2 Large Round Ottoman	PAS FS1 OS4 Large Square Ottoman
Height	17.5"	17.5"
Width	40"	40"
Depth	40"	40"
Seat Depth	40"	40"
Seat Height	17.5"	17.5"
Weight	74.5 lb	89.5 lb
COM (Fully Upholstered)	3.35 yd	3.44 yd
COM (Multi-Upholstery)		
Seat Top	1.56 yd	1.56 yd
Chassis	1.88 yd	1.88 yd
Weight Capacity	800 lb	800 lb
Warranty		

SPECIFICATIONS: MINI OTTOMAN TABLES

Model:	FS1 OS1 Mini Round Table	FS1 OS3 Mini Square Table
Height	13"	13"
Width	24"	24"
Depth	24"	24"
Weight	37 lb	37 lb
COM	1.25 yd	1.25 yd
Weight Capacity	400 lb	400 lb
Warranty		

SPECIFICATIONS: LARGE OTTOMAN TABLES

Model:	FS1 OS2 Large Round Table	FS1 OS4 Large Square Table
Height	13.3"	13.3"
Width	40"	40"
Depth	40"	40"
Weight	85 lb	85 lb
COM	2 yd	2 yd
Weight Capacity	800 lb	800 lb
Warranty		

Paséa

INLINE TABLES

Lounge that works.

Whether it's to rest your bag or your body, the modularity of the Paséa collection makes it easy to ensure there's always an extra place. This comprehensive collection includes a variety of inline tables that pair perfectly with gapless seats and benches.

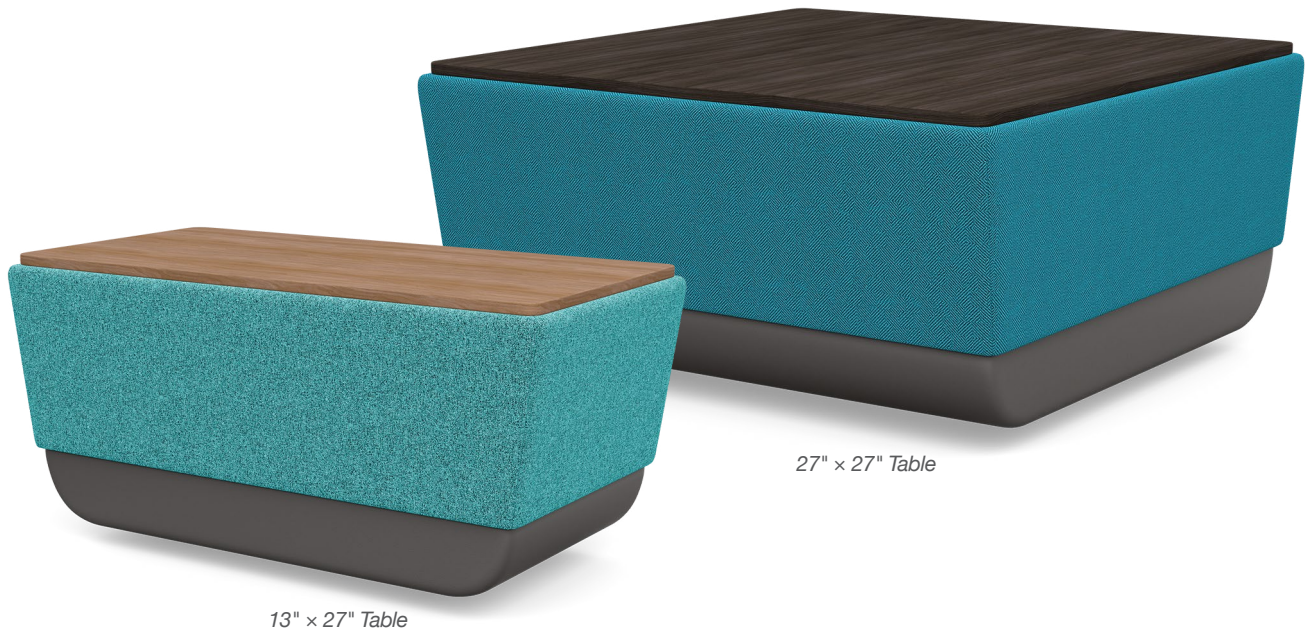

Featured Models

13" x 27" :: \$881

13" x 27" table, laminate top, grade 1 textile

27" x 27" :: \$1,181

27" x 27" table, laminate top, grade 1 textile

90° CORNER :: \$1,828

90-degree corner table, laminate top, grade 1 textile

Features

- Choose from an assortment of large and mini ottoman
Designed by Q Design
- Part of a comprehensive collection that also includes
seats, benches and ottomans
- Provide extra convenience with available AC and USB
power options
- Three tables that are designed to be used inline with
Paséa seats and benches: the 13" x 27" table, 27" x 27"
table and the 90-degree corner table
- Adjustable glides standard on all Paséa tables (except
mini ottoman tables).
- Blend with any environment using graphite or slate
base colors
- Tabletops come in five attractive laminate finishes

1. Product

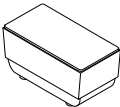
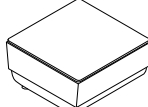
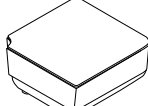
Model	Code	Price	
13" x 27" Table	FS18 BNS7	\$881	
27" x 27" Table	FS18 BNS1	\$1,181	
90-Degree Corner Table	FS18 BNS5	\$1,828	

2. Table Base





Base Finish	Code	Price
Graphite	LBC2	+ \$0
Slate	LBC3	+ \$0

3. Tabletop

Top Material	Code	Price
Laminate	TM3	+ \$0

Laminate Finish	Code	Price
Field Elm	TL13	+ \$0
Uptown Walnut	TL14	+ \$0
Skyline Walnut	TL15	+ \$0
Frosty White	TL16	+ \$0
Classic Linen	TL17	+ \$0

4. Power

Power Type	Code	Price	
AC/110V and Dual USB	PT2	+ \$300	 
Dual USB	PT3	+ \$175	
AC/110V	PT4	+ \$125	

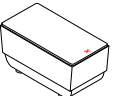
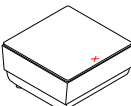
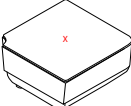
Power Location	Code	Price	
Top Rear	PTRC	Priced by Power Type	 
Top Center	PTCC	Priced by Power Type	

13" x 27" (FS18 BNS1) and 27" x 27" (FS18 BNS1) tables are available with top rear power only. 90-degree corner table (FS18 BNS5) is available with top center power only.

5. Material

Fully Upholstered	Code	Price
13" x 27" Table		
COM	COM	+ \$0
Fabric/Vinyl Grade 1	FG1/VG1	+ \$0
Fabric/Vinyl Grade 2	FG2/VG2	+ \$27
Fabric/Vinyl Grade 3	FG3/VG3	+ \$42
Fabric/Vinyl Grade 4	FG4/VG4	+ \$60
Fabric/Vinyl Grade 5	FG5/VG5	+ \$90
Fabric/Vinyl Grade 6	FG6/VG6	+ \$120
Fabric/Vinyl Grade 7	FG7/VG7	+ \$150
27" x 27" Table		
COM	COM	+ \$0
Fabric/Vinyl Grade 1	FG1/VG1	+ \$0
Fabric/Vinyl Grade 2	FG2/VG2	+ \$40
Fabric/Vinyl Grade 3	FG3/VG3	+ \$63
Fabric/Vinyl Grade 4	FG4/VG4	+ \$90
Fabric/Vinyl Grade 5	FG5/VG5	+ \$135
Fabric/Vinyl Grade 6	FG6/VG6	+ \$180
Fabric/Vinyl Grade 7	FG7/VG7	+ \$225
90-Degree Corner Table		
COM	COM	+ \$0
Fabric/Vinyl Grade 1	FG1/VG1	+ \$0
Fabric/Vinyl Grade 2	FG2/VG2	+ \$40
Fabric/Vinyl Grade 3	FG3/VG3	+ \$63
Fabric/Vinyl Grade 4	FG4/VG4	+ \$90
Fabric/Vinyl Grade 5	FG5/VG5	+ \$135
Fabric/Vinyl Grade 6	FG6/VG6	+ \$180
Fabric/Vinyl Grade 7	FG7/VG7	+ \$225

6. Packaging

Packaging	Code	Price
Fully Assembled in Carton	P1	+ \$0

SPECIFICATIONS

Model:	FS18 BNS7 13" x 27" Table	FS18 BNS1 27" x 27" Table	FS18 BNS5 90-Degree Corner Table
Height	13.3"	13.3"	13.3"
Width	13.4"	27"	30"
Depth	27"	27"	30"
Weight	35 lb	64 lb	64 lb
COM	1.25 yd	1.5 yd	1.5 yd
Weight Capacity Warranty	400 lb	400 lb	400 lb

Visit Modular

LOUNGE SEATING

Sit. Stay awhile.

With contemporary aesthetics, the Visit Modular collection features flexible modularity and arm options for inventive space planning. Link arm and armless models with ganging brackets and an ottoman for common areas and waiting rooms. Handy seat-back handles and functional tablet arms make Visit Modular perfect for collaborative spaces and pull-up meetings.

Our customizable lounge line is now even more convenient thanks to our new power modules. Crafted with minimal seams for smoother integration and a cleaner look, they can be installed on either the fronts or sides of our models.



Armless Club Chair

Featured Models

ARMLESS CLUB CHAIR :: \$1,374

Club chair, armless, black plastic feet, multi-upholstery, grade 2 vinyl

UPHOLSTERED ARM CLUB CHAIR :: \$1,695

Club chair, two upholstered arms, brushed aluminum pole feet, fully upholstered, grade 3 textile

WOOD ARM CLUB CHAIR :: \$1,800

Club chair, two wood arms, square wood tapered feet, fully upholstered, grade 2 seat and back textile

Features

- Armless chair and ottoman for modular seating
- Ganging brackets
- Two arm styles: armless, upholstered or wood
- Optional tablet arm
- Back hook or handle
- Optional power module available
- 300 lb weight capacity warranty



Wood Arm Club Chair

CLUB CHAIR AND OTTOMAN

1. Product

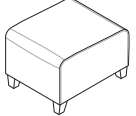
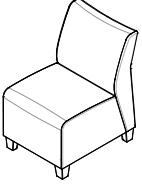
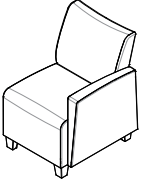
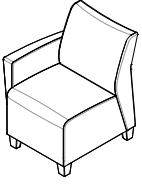
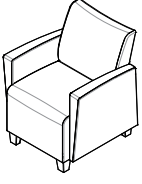
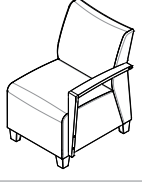
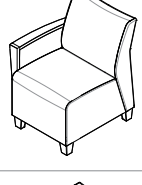
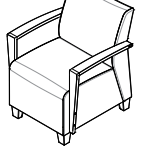
Model and Arm Style	Code	Price	
Ottoman	VS FS1	\$609	
Club Chair, Armless	VS	\$1,225	
Club Chair With Upholstered Left Arm	VS FS12	\$1,325	
Club Chair With Upholstered Right Arm	VS FS10	\$1,325	
Club Chair With Upholstered Left and Right Arms	VS FS8	\$1,425	
Club Chair With Wood Left Arm	VS FS11	\$1,425	
Club Chair With Wood Right Arm	VS FS9	\$1,425	
Club Chair With Wood Left and Right Arms	VS FS7	\$1,625	

Left and right arms are designated from the seated position.

VISIT MODULAR

GSA SIN #: 33721

2. Back

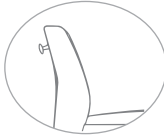

Back Options	Code	Price	
Hook/Handle (Not Available on Ottoman)	BX1	+ \$147	

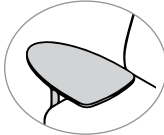
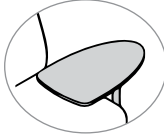
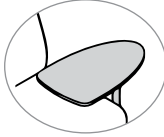
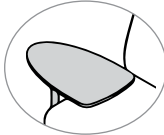
3. Arm

Tablet Arm	Code	Price	
Tablet Arm, Right, Black Pole	AX3	+ \$342	
Tablet Arm, Right, Silver Pole	AX2	+ \$342	
Tablet Arm, Left, Black Pole	AX6	+ \$342	
Tablet Arm, Left, Silver Pole	AX5	+ \$342	



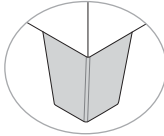
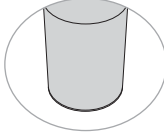
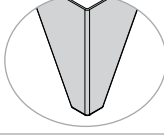
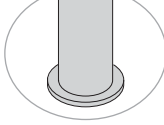

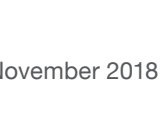

Tablet arms are available on the left or right side if the chair is configured as armless.

4. Foot

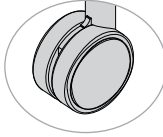
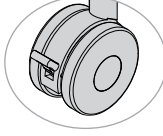
Front Foot Style and Color	Code	Price	
Feet			
Standard Plastic, Black	LS1	+ \$0	
Wood Tapered Square	LS12	+ \$70	
Wood Tapered Cylinder	LS11	+ \$70	
Metal Angular, Brushed Aluminum	LS6	+ \$60	
Metal 1.5" Pole, Brushed Aluminum	LS7	+ \$60	
Metal 1.5" Pole, Silver Powder Coat	LS8	+ \$60	

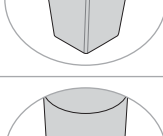
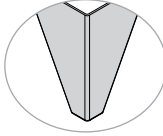
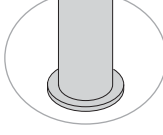
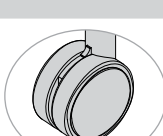
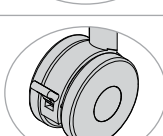
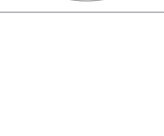
CLUB CHAIR AND OTTOMAN

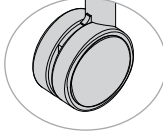
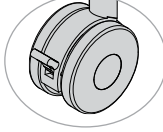
4. Foot (Cont.)

Front Foot Style and Color	Code	Price	
Casters			
Non-Locking Caster, Black	LS2	+ \$50	
Non-Locking Caster, Silver	LS3	+ \$50	
Locking Caster, Black	LS4	+ \$60	
Locking Caster, Silver	LS5	+ \$60	
Back Foot Style and Color			
Feet			
Standard Plastic, Black	LS1	+ \$0	
Wood Tapered Square	LS12	+ \$70	
Wood Tapered Cylinder	LS11	+ \$70	
Metal Angular, Brushed Aluminum	LS6	+ \$60	
Metal 1.5" Pole, Brushed Aluminum	LS7	+ \$60	
Metal 1.5" Pole, Silver Powder Coat	LS8	+ \$60	
Casters			
Non-Locking Caster, Black	LS2	+ \$50	
Non-Locking Caster, Silver	LS3	+ \$50	
Locking Caster, Black	LS4	+ \$60	
Locking Caster, Silver	LS5	+ \$60	

VISIT MODULAR

GSA SIN #: 33721

5. Frame (For Wooden Feet L11/L12)

Frame Finish Color	Code	Price
Clear Maple	FCW1	+ \$0
Medium Cherry	FCW2	+ \$0
Amber Mahogany	FCW3	+ \$0
Espresso	FCW4	+ \$0
Stain-to-Match	STM	+ \$70
New Custom Stain	STL	+ \$275

New Custom Stain (STL): If stain is not in our library, add this one-time fee in addition to the stain-to-match (STM) cost.



Upholstered Arm Club Chair

CLUB CHAIR AND OTTOMAN

6. Power

Location	Code	Price
Right Hand, Front of Chair	PFR	+ \$250
Left Hand, Front of Chair	PFL	+ \$250
Right Hand, Side of Chair (Only Available on Armless Model)	PSR	+ \$250
Left Hand, Side of Chair (Only Available on Armless Model)	PSL	+ \$250

Color	Code	Price
Silver	PC2	+ \$0
Black	PC1	+ \$0

Power only available on the side of chairs.

Each chair can only have power specified in one of the location options. Power cannot be specified on the same side of a chair where a tablet arm or magazine rack is specified.

GSA SIN #: 33721

7. Material

Protection		Price			
CAL 133		Club: 2 Upholstered Arms	Club: 1 Upholstered Arm	Club: Armless or Wood Arms	Ottoman
CAL 133	UCAL	+ \$262	+ \$262	+ \$262	+ \$262
Cleaning		Price			
Moisture Barrier		Club: 2 Upholstered Arms	Club: 1 Upholstered Arm	Club: Armless or Wood Arms	Ottoman
Moisture Barrier Seat	UM2	+ \$59	+ \$59	+ \$59	+ \$59
Moisture Barrier Back	UM1	+ \$59	+ \$59	+ \$59	+ \$59
Moisture Barrier Back and Seat	UM3	+ \$118	+ \$118	+ \$118	+ \$118
Upholstery		Price			
Fully Upholstered		Club: 2 Upholstered Arms	Club: 1 Upholstered Arm	Club: Armless or Wood Arms	Ottoman
COM	COM	+ \$0	+ \$0	+ \$0	+ \$0
Fabric/Vinyl Grade 1	FG1/VG1	+ \$0	+ \$0	+ \$0	+ \$0
Fabric/Vinyl Grade 2	FG2/VG2	+ \$50	+ \$39	+ \$35	+ \$23
Fabric/Vinyl Grade 3	FG3/VG3	+ \$150	+ \$119	+ \$105	+ \$68
Fabric/Vinyl Grade 4	FG4/VG4	+ \$250	+ \$198	+ \$175	+ \$113
Fabric/Vinyl Grade 5	FG5/VG5	+ \$375	+ \$298	+ \$263	+ \$169
Fabric/Vinyl Grade 6	FG6/VG6	+ \$550	+ \$439	+ \$385	+ \$248
Fabric/Vinyl Grade 7	FG7/VG7	+ \$775	+ \$616	+ \$543	+ \$349
COL	COL	+ \$800	+ \$636	+ \$556	+ \$363
Leather Grade 1	LG1	+ \$800	+ \$636	+ \$556	+ \$363
Leather Grade 2	LG2	+ \$1,050	+ \$834	+ \$730	+ \$476
Leather Grade 3	LG3	+ \$1,450	+ \$1,152	+ \$1,008	+ \$657
Multi-Upholstery		Price			
Multi-Upholstery	UMU	+ \$113			
Seat or Top and Front Textile Only		Club: 2 Upholstered Arms (Seat Textile)	Club: 1 Upholstered Arm (Seat Textile)	Club: Armless or Wood Arms (Seat Textile)	Ottoman (Top and Front Textile)
COM	COM	+ \$0	+ \$0	+ \$0	+ \$0
Fabric/Vinyl Grade 1	FG1/VG1	+ \$0	+ \$0	+ \$0	+ \$0
Fabric/Vinyl Grade 2	FG2/VG2	+ \$15	+ \$15	+ \$18	+ \$12
Fabric/Vinyl Grade 3	FG3/VG3	+ \$45	+ \$45	+ \$53	+ \$34
Fabric/Vinyl Grade 4	FG4/VG4	+ \$74	+ \$74	+ \$88	+ \$57
Fabric/Vinyl Grade 5	FG5/VG5	+ \$111	+ \$111	+ \$132	+ \$85
Fabric/Vinyl Grade 6	FG6/VG6	+ \$163	+ \$163	+ \$193	+ \$124
Fabric/Vinyl Grade 7	FG7/VG7	+ \$229	+ \$229	+ \$272	+ \$175
COL	COL	+ \$237	+ \$237	+ \$278	+ \$182
Leather Grade 1	LG1	+ \$237	+ \$237	+ \$278	+ \$182
Leather Grade 2	LG2	+ \$310	+ \$310	+ \$365	+ \$238
Leather Grade 3	LG3	+ \$428	+ \$428	+ \$504	+ \$329

If different fabrics are selected for the seat and back, add the multiple upholstery upcharge as well, even if the fabrics are the same grade
Please reference the Textile Reference Guide for pricing on fabric over grade 7 and leather over grade 3.

GSA SIN #: 33721

7. Material (Cont.)

Upholstery (Cont.)		Price			
Back or Side Textile Only	Code	Club: 2 Upholstered Arms (Back Textile)	Club: 1 Upholstered Arm (Back Textile)	Club: Armless or Wood Arms (Back Textile)	Ottoman (Side Textile)
COM	COM	+\$0	+\$0	+\$0	+\$0
Fabric/Vinyl Grade 1	FG1/VG1	+\$0	+\$0	+\$0	+\$0
Fabric/Vinyl Grade 2	FG2/VG2	+\$15	+\$15	+\$18	+\$12
Fabric/Vinyl Grade 3	FG3/VG3	+\$45	+\$45	+\$53	+\$34
Fabric/Vinyl Grade 4	FG4/VG4	+\$74	+\$74	+\$88	+\$57
Fabric/Vinyl Grade 5	FG5/VG5	+\$111	+\$111	+\$132	+\$85
Fabric/Vinyl Grade 6	FG6/VG6	+\$163	+\$163	+\$193	+\$124
Fabric/Vinyl Grade 7	FG7/VG7	+\$229	+\$229	+\$272	+\$175
COL	COL	+\$237	+\$237	+\$278	+\$182
Leather Grade 1	LG1	+\$237	+\$237	+\$278	+\$182
Leather Grade 2	LG2	+\$310	+\$310	+\$365	+\$238
Leather Grade 3	LG3	+\$428	+\$428	+\$504	+\$329
Arm/Arms Textile Only	Code	Club: 2 Upholstered Arms (Arms Only)	Club: 1 Upholstered Arm (Arm Only)		
COM	COM	+\$0	+\$0		
Fabric/Vinyl Grade 1	FG1/VG1	+\$0	+\$0		
Fabric/Vinyl Grade 2	FG2/VG2	+\$21	+\$11		
Fabric/Vinyl Grade 3	FG3/VG3	+\$62	+\$31		
Fabric/Vinyl Grade 4	FG4/VG4	+\$103	+\$52		
Fabric/Vinyl Grade 5	FG5/VG5	+\$154	+\$77		
Fabric/Vinyl Grade 6	FG6/VG6	+\$226	+\$113		
Fabric/Vinyl Grade 7	FG7/VG7	+\$318	+\$159		
COL	COL	+\$328	+\$164		
Leather Grade 1	LG1	+\$328	+\$164		
Leather Grade 2	LG2	+\$431	+\$216		
Leather Grade 3	LG3	+\$595	+\$298		

If different fabrics are selected for the seat and back, add the multiple upholstery upcharge as well, even if the fabrics are the same grade.

Please reference the Textile Reference Guide for pricing on fabric over grade 7 and leather over grade 3.

8. Options

Ganging Bracket	Code	Price
One Set of Ganging Brackets, Left-Attaching	XGVL	+\$52
One Set of Ganging Brackets, Right-Attaching	XGVR	+\$52
Two Sets of Ganging Brackets, One Set Left-Attaching and One Set Right-Attaching	XGV	+\$103

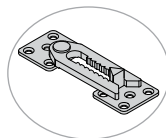

GSA SIN #: 33721

SPECIFICATIONS

Model:	VS FS8 Club Chair With 2 Upholstered Arms	VS FS11 / VS FS12 Club Chair With 1 Upholstered Arm	VS Armless Club Chair	VS FS7 Club Chair With Wood Arm or Arms	VS S1 Ottoman
Height	35"	35"	35"	35"	N/A
Width	28.5"	28.5"	22.5"	28.5"	N/A
Depth	29"	29"	29"	29"	N/A
Seat Width	22"	22"	22"	22"	22"
Seat Depth	21"	21"	21"	21"	21"
Seat Height	19.5"	19.5"	19.5"	20"	17.5"
Back Height	17"	17"	17"	17"	N/A
Arm Height	26.5"	26.5"	N/A	26.5"	N/A
Weight	48 lb	43 lb	38 lb	48 lb	28 lb
COM					
Fully Upholstered	5.4 yd	4.25 yd	3.5 yd	3.5 yd	1.88 yd
Seat Only	1.9 yd	1.9 yd	1.9 yd	1.9 yd	N/A
Back Only	2.2 yd	2.2 yd	2.2 yd	2.2 yd	N/A
Arms Only	2.9 yd	1.75 yd	2.9 yd	2.9 yd	N/A
Side Only	N/A	N/A	N/A	N/A	0.94 yd
Seat and Side Only	N/A	N/A	N/A	N/A	1.88 yd
COL					
Fully Upholstered	83.3 sq ft	72 sq ft	54.5 sq ft	54.5 sq ft	29.4 sq ft
Seat Only	29.4 sq ft	29.4 sq ft	29.4 sq ft	29.4 sq ft	N/A
Back Only	34.3 sq ft	34.3 sq ft	34.3 sq ft.	34.3 sq ft	N/A
Arms Only	44.1 sq ft	26 sq ft	44.1 sq ft	44.1 sq ft	N/A
Side Only	N/A	N/A	N/A	N/A	14.7 sq ft
Seat and Side Only	N/A	N/A	N/A	N/A	29.4 sq ft
Weight Capacity	300 lb	300 lb	300 lb	300 lb	300 lb
Warranty (Per Seat)					

Yardage requirements for COM and COL are for solid and non-directional fabrics. Additional material may be required for larger repeating patterns.

Tables and Desks

COFFEE TABLE | END TABLE
HEIGHT-ADJUSTABLE TABLE
MULTIPURPOSE TABLE
DESK AND RETURN

Mezzanine

CUBE END TABLE, COFFEE TABLE AND CORNER TABLE

Get in top shape.

Mezzanine® tables are available in two popular styles—cube and occasional. From the modernist cube to the transitional occasional style, these accent pieces are designed to complement any SitOnIt Seating chair, settee or sofa. Built with the highest quality veneers and hardwoods, Mezzanine tables are designed to withstand the repeated use required of high traffic lobbies and waiting areas. Add a finishing touch to any space with tables as distinctive as your seating.



Coffee Table

Featured Models

END TABLE :: \$821

End table, standard black plastic feet

COFFEE TABLE :: \$1,209

Coffee table, wood tapered square feet

CORNER TABLE :: \$1,436

Corner table, brushed aluminum pole feet

Features

- Armless chair and ottoman for modular seating
- Ganging brackets
- Two arm styles: armless, upholstered or wood

1. Product

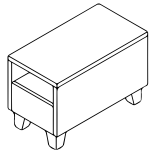
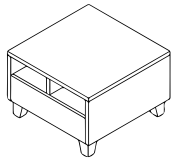
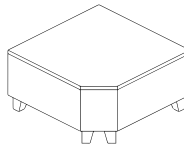
Table Type	Code	Price	
End Table	MCM TT1	\$821	
Coffee Table	MCM TT2	\$1,069	
Corner Table	MCM TT3	\$1,316	



End Table



CUBE END TABLE, COFFEE TABLE AND CORNER TABLE

2. Appearance

Table Finish Color	Code	Price
Clear Maple	FCW1	+ \$0
Medium Cherry	FCW2	+ \$0
Amber Mahogany	FCW3	+ \$0
Espresso	FCW4	+ \$0
Stain-to-Match	STM	+ \$70
New Custom Stain	STL	+ \$275

New Custom Stain (STL): If stain is not in our library, add this one-time \$275 net fee in addition to the \$70 stain-to-match (STM) cost.

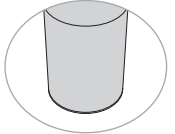
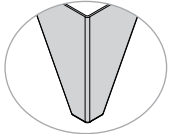
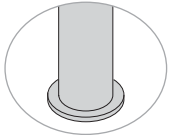
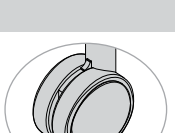
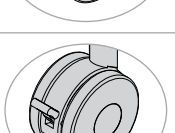
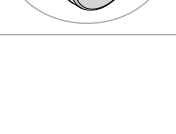
2. Feet

Foot Style and Color	Code	Price	
Feet			
Standard Plastic, Black	LS1	+ \$0	
Wood Tapered Square	LS12	+ \$140	
Wood Tapered Cylinder	LS11	+ \$140	
Metal Angular, Brushed Aluminum	LS6	+ \$120	
Metal 1.5" Pole, Brushed Aluminum	LS7	+ \$120	
Metal 1.5" Pole, Silver Powder Coat	LS8	+ \$120	
Castors			
Non-Locking Caster, Black	LS2	+ \$100	
Non-Locking Caster, Silver	LS3	+ \$100	
Locking Caster, Black	LS4	+ \$120	
Locking Caster, Silver	LS5	+ \$120	

MEZZANINE

GSA SIN #: 33721

CUBE END TABLE, COFFEE TABLE AND CORNER TABLE

3. Options

Ganging Brackets	Code	Price	
One Set, Left-Attaching	XGVL	+ \$52	
One Set, Right-Attaching	XGVR	+ \$52	
Two Sets, Left- and Right-Attaching	XGV	+ \$103	

4. Packaging

Packaging	Code	Price	
Knocked Down	P7	+ \$0	

SPECIFICATIONS

Model:	MCM TT1 End Table	MCM TT2 Coffee Table	MCM TT3 Corner Table
Height	17"	17"	17"
Width	13.5"	25"	31.5"
Depth	25"	25"	31.5"
Weight	35 lb	52 lb	59 lb



Corner Table

Mezzanine

OCCASIONAL TABLE

Get in top shape.

Mezzanine® tables are available in two popular styles—cube and occasional. From the modernist cube to the transitional occasional style, these accent pieces are designed to complement any chair, settee or sofa. Built with the highest quality veneers and hardwoods, Mezzanine tables are designed to withstand the repeated use required of high traffic lobbies and waiting areas. Add a finishing touch to any space with tables as distinctive as your seating.



Square Occasional Table

Featured Models

SQUARE :: \$1,148

Square occasional table, 24" high, wood tapered square legs

RECTANGULAR :: \$1,519

Rectangular occasional table, 24" high, wood tapered square legs



OVAL :: \$1,619

Oval occasional table, 18" high, brushed aluminum pole legs

Features

- Four occasional table shapes
- Three edge types
- Three leg styles
- Four wood stain finishes and stain-to-match program

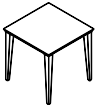
1. Product

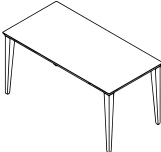
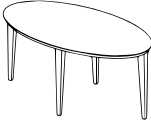
Table Type	Code	Price	
Square Occasional Table	MZM TT8	\$1,088	
Round Occasional Table	MZM TT6	\$1,088	
Rectangular Occasional Table	MZM TT5	\$1,459	
Oval Occasional Table	MZM TT4	\$1,459	

2. Size

Table Top Size	Code	Price	
For Square and Round Tables			
21"	TZ21	+\$0	
24"	TZ24	+\$99	
36"	TZ36	+\$495	
For Rectangular and Oval Tables			
48"	TZ48	+\$0	
Table Height	Code	Price	
16"	TH16	+\$0	
18"	TH18	+\$20	
21"	TH21	+\$40	
24"	TH24	+\$60	

3. Appearance

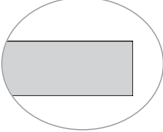
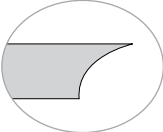
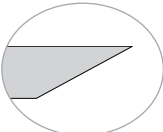
Table Top Edge Style	Code	Price	
Square	TE1	+\$0	
Bevel	TE2	+\$0	
Knife	TE3	+\$0	

Finish Color	Code	Price	
Clear Maple	FCW1	+\$0	
Medium Cherry	FCW2	+\$0	
Amber Mahogany	FCW3	+\$0	
Espresso	FCW4	+\$0	
Stain-to-Match	STM	+\$70	
New Custom Stain	STL	+\$275	

New Custom Stain (STL): If stain is not in our library, add this one-time \$275 net fee in addition to the \$70 stain-to-match (STM) cost.

4. Legs

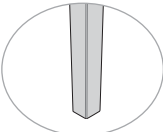
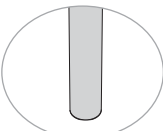
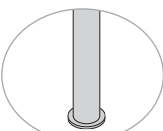
Leg Style	Code	Price	
Wood Tapered Square Leg	LSL2	+\$0	
Wood Tapered Cylinder Leg	LSL3	+\$0	
Metal 1.5" Pole, Brushed Aluminum Leg	LSL1	+\$140	

5. Options

Protection	Code	Price
Protective Wood Guard Clear Tape	LX1	+ \$84

Protective Wood Guard (LX1) is available on wood legs (LSL2/LSL3) only.

4. Packaging

Packaging	Code	Price
Knocked Down	P7	+ \$0

OCCASIONAL TABLES

SPECIFICATIONS: SQUARE

Model:	MZM TT8 Square Table		
	21"	24"	36"
Width	21"	24"	36"
Depth	21"	24"	36"
Weight	30 lb	34 lb	57 lb

Model:	MZM TT6 Round Table		
	21"	24"	36"
Width	21"	24"	36"
Depth	21"	24"	36"
Weight	27 lb	30 lb	48 lb

Model:	MZM TT5 Rectangle Table	MZM TT4 Oval Table
	Width	48"
Depth	24"	24"
Weight	52 lb	52 lb

Square, round, rectangular and oval tables are available in multiple heights.



Rectangular Occasional Table

Ocala

FLIP-TOP TABLES

Mighty and mobile.

The Ocala flip-top table is the simple yet sophisticated nesting table that solves all of your training and meeting room needs. Set-up takes just seconds – table surface flips up and locks for use, then breaks down with the pull of a lever. The table nests for convenient, space-saving storage.



24" x 60"

Chair sold separately; see page 380 for Movi.

Featured Models

24" x 60" :: \$647

24" x 60" top, flip-top base, no grommets

30" x 72" :: \$765

30" x 72" top, flip-top base, no grommets

TABLETOP

TOPS AND BASES ARE SPECIFIED AND SOLD SEPARATELY.

Features

- Welded and bolted construction with steel end caps
- Twelve different durable laminate options to fit your style
- Optional grommets for easy and clean setup of electronic devices
- Silver and white base finishes
- Casters are standard on all models
- 60", 66" and 72" top lengths
- 130 lb weight capacity warranty

SPECIFICATIONS

	3061 TBT2 Ocala Flip-Top Table
Height	28.59"
Height With Top Flipped Up	41.11"
Base Length	58.99"
Foot Length:	21.9"
Base Top Support Length:	52.84"
Distance Between Legs:	50.15"
Weight Capacity Warranty	130 lb

Height includes 1.125" tabletop and casters.

1. Product

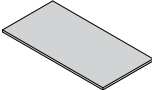
Product Type	Code	Price	
Rectangular Top	3061 TBT2	Priced by Size	

2. Size

Tabletop Size (D x W)	Code	Price
24" x 60"	TZ2460	\$236
24" x 66"	TZ2466	\$261
24" x 72"	TZ2472	\$284
30" x 60"	TZ3060	\$295
30" x 66"	TZ3066	\$325
30" x 72"	TZ3072	\$354

3. Top Finish

Laminate	Code	Price
Ankara Cherry	TL18	+ \$0
Black	TL19	+ \$0
Brazilian Walnut	TL20	+ \$0
Cabinet Maple	TL21	+ \$0
Contour White	TL22	+ \$0
Driftwood	TL23	+ \$0
Folkstone Grey	TL24	+ \$0
Libretti	TL25	+ \$0
Queenston Oak	TL26	+ \$0
Sandalwood	TL27	+ \$0
Walnut Amati	TL28	+ \$0
White	TL29	+ \$0

4. Grommets

Grommet Location	Code	Price	
None	GP00	+ \$0	
Left	GP01	+ \$30	
Center	GP02	+ \$30	
Right	GP03	+ \$30	
Left and Center	GP04	+ \$60	
Left and Right	GP05	+ \$60	
Right and Center	GP06	+ \$60	
Left, Right and Center	GP07	+ \$90	
Grommet Color	Code	Price	
Black	GC01	+ \$0	
White	GC02	+ \$0	

TABLE BASE

TOPS AND BASES ARE SPECIFIED AND SOLD SEPARATELY.

1. Product

Product Type	Code	Price	
Flip-Top Base	3062 TBT2	\$411	

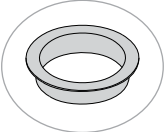
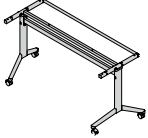
2. Size

Tabletop Size (D x W)	Code	Price
24" x 60"	TZ2460	+ \$0
24" x 66"	TZ2466	+ \$0
24" x 72"	TZ2472	+ \$0
30" x 60"	TZ3060	+ \$0
30" x 66"	TZ3066	+ \$0
30" x 72"	TZ3072	+ \$0

Bases require the specification of a tabletop size. Bases take their size from their corresponding tabletop.

3. Base Finish

Paint Color	Code	Price	
Silver	BF01	+ \$0	
White	BF02	+ \$0	



Switchback

2-LEG HEIGHT-ADJUSTABLE TABLE BUNDLE

Find your fit.

Create a smarter workplace solution with Switchback, our number one height-adjustable table. Known for its class-leading anti-collision technology, compact shipping size and instant installation, it's the go-to for a dynamic workspace—and it gets even better when you bundle it with screens, power modules and keyboard trays for a complete, multifunctional workstation.



Featured Bundle

ALL-IN-ONE :: \$3,552

2-leg 3-stage base, fixed glides, 24" x 60" pre-drilled rectangular tabletop, no grommets, height-adjustable screen mount, 30" x 60" fabric screen, wire basket with power strip, laptop tray with HAT mechanism and U-brackets for crossrails, mini platform keyboard tray with mini trackless mechanism, half moon pencil drawer, Current clamp mount power module, Unity G2 single screen monitor arm, mobile pedestal with upholstered pad

Features

- The bundle can be built with any of Switchback's 2-leg models
- Switchback has three available base finishes and twelve tabletop finishes to fit your style
- Bundles have easy specification and installation; order together and the pilot holes for the accessories will be predrilled and ready to go
- Multiple monitor arm choices, including heavy duty options that support up to 33 lb
- Wire management and power module options to keep all of your electronics organized and powered on

1. Switchback Tabletop

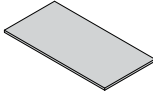
Product Type	Code	Price	
Top for 2-Leg Base	3161	Priced by Size	
Product Style	Code	Price	
2-Stage T-Leg Base	TBT6	Priced by Size	
3-Stage T-Leg Base	TBT7	Priced by Size	
2-Stage C-Leg Base	TBT6C	Priced by Size	
3-Stage, C-Leg Base	TBT7C	Priced by Size	
Tabletop Size (D x W)	Code	Price	
24" x 60"	TZ2460	\$236	
24" x 66"	TZ2466	\$261	
24" x 72"	TZ2472	\$284	
30" x 60"	TZ3060	\$295	
30" x 66"	TZ3066	\$325	
30" x 72"	TZ3072	\$354	

1. Switchback Tabletop (Cont.)

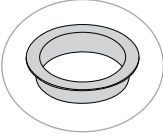
Laminate	Code	Price	
Ankara Cherry	TL18	+ \$0	
Black	TL19	+ \$0	
Brazilian Walnut	TL20	+ \$0	
Cabinet Maple	TL21	+ \$0	
Contour White	TL22	+ \$0	
Driftwood	TL23	+ \$0	
Folkstone Grey	TL24	+ \$0	
Libretti	TL25	+ \$0	
Queenston Oak	TL26	+ \$0	
Sandalwood	TL27	+ \$0	
Walnut Amati	TL28	+ \$0	
White	TL29	+ \$0	
Grommet Location	Code	Price	
None	GP00	+ \$0	
Left	GP01	+ \$30	
Center	GP02	+ \$30	
Right	GP03	+ \$30	
Left and Center	GP04	+ \$60	
Left and Right	GP05	+ \$60	
Right and Center	GP06	+ \$60	
Left, Right and Center	GP07	+ \$90	
Grommet Color	Code	Price	
Black	GC01	+ \$0	
White	GC02	+ \$0	
Pilot Holes	Code	Price	
Pre-Drilled for Accessories	BNDL01	+ \$0	

2. Switchback 2-Leg Base

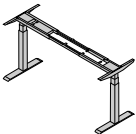
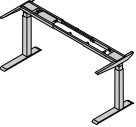
Product Type	Code	Price	
2-Leg Base	3162	\$840	
Base Style	Code	Price	
2-Stage T-Leg Base	TBT6	\$730	
3-Stage T-Leg Base	TBT7	\$768	
2-Stage C-Leg Base	TBT6C	\$730	
3-Stage C-Leg Base	TBT7C	\$768	

2. Switchback 2-Leg Base (Cont.)

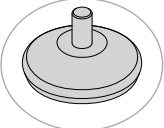
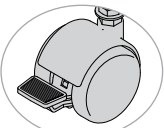
Tabletop Size (D x W)	Code	Price	
24" x 60"	TZ2460	+ \$0	
24" x 66"	TZ2466	+ \$0	
24" x 72"	TZ2472	+ \$0	
30" x 60"	TZ3060	+ \$0	
30" x 66"	TZ3066	+ \$0	
30" x 72"	TZ3072	+ \$0	
Paint Color	Code	Price	
Silver	BF01	+ \$0	
White	BF02	+ \$0	
Black	BF03	+ \$0	
Foot Style	Code	Price	
Glides	LS18	+ \$0	
Casters	LS19	+ \$109	

3. Screens

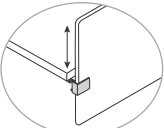
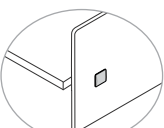
Product Type	Code	Price	
Screen	3090	Priced by Size	
Mount Style	Code	Price	
Midway	MT5	+ \$76	
Height-Adjustable	MT6	+ \$80	
Screen Material	Code	Price	
Frosted Acrylic	DT101	+ \$0	
Fabric	DT201	+ \$0	
Markerboard	DT701	+ \$0	

SWITCHBACK BUNDLE

3. Screens (Cont.)

Screen Size	Code	Price	
Frosted Acrylic			
24" x 60"	DS2460	+ \$498	
24" x 66"	DS2466	+ \$603	
24" x 72"	DS2472	+ \$664	
30" x 60"	DS3060	+ \$656	
30" x 66"	DS3066	+ \$728	
30" x 72"	DS3072	+ \$808	
Fabric			
24" x 60"	DS2460	+ \$478	
24" x 66"	DS2466	+ \$579	
24" x 72"	DS2472	+ \$638	
30" x 60"	DS3060	+ \$630	
30" x 66"	DS3066	+ \$700	
30" x 72"	DS3072	+ \$776	
Markerboard			
24" x 60"	DS2460	+ \$392	
24" x 66"	DS2466	+ \$431	
24" x 72"	DS2472	+ \$470	
30" x 60"	DS3060	+ \$475	
30" x 66"	DS3066	+ \$522	
30" x 72"	DS3072	+ \$570	

Height-adjustable mount only available with 30" x 60" screen. For higher grade fabric pricing see page 452.

4. Wire Management

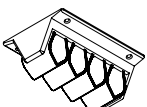
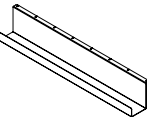
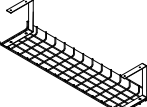
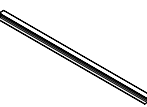
Product Type	Code	Price	
Horizontal Wire Management	3152 WM01	+ \$54	
J Chan Without Power	3152 WM03	+ \$93	
Wire Basket Without Power	3152 WM05	+ \$67	
Wire Channel	3152 WM02	+ \$41	

5. Power Strip

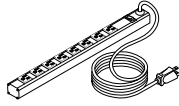
Product Type	Code	Price	
Power Strip	3130 PST1 WM00	+ \$155	

6. Laptop Tray

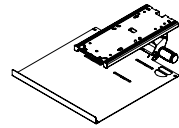
Product Type	Code	Price	
Laptop Tray	3154	Priced by Style	
Mechanism Style	Code	Price	
HAT	KBM01	+ \$107	
Platform Style	Code	Price	
Laptop Tray	KBP01	+ \$110	
Brackets	Code	Price	
U-Brackets for Crossrails	KBTA	+ \$80	

7. Keyboard Tray

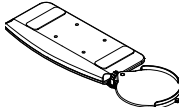
Product Type	Code	Price	
Keyboard Tray	3151	Priced by Style	
Mechanism Style	Code	Price	
Mini Trackless	KBM04	+ \$234	
Platform Style	Code	Price	
Mini Platform	KBP03	+ \$232	

8. Pencil Storage

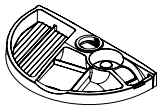
Product Type	Code	Price	
Half Moon	3155 PDT02	+ \$86	

9. Power Module

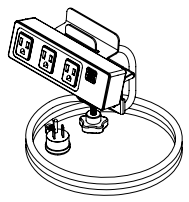
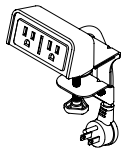
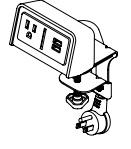

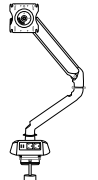
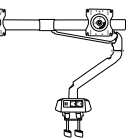
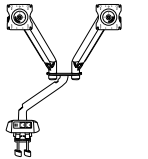
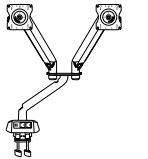

Product Type	Code	Price	
Power	3130	Priced by Style	
Product Style	Code	Price	
Current With Clamp Mount	PCC	+ \$199	
EON Clamp On, Dual Outlet	PTC PT5	+ \$99	
EON Clamp On, Single Outlet, Dual USB	PTC PT2	+ \$145	
Power Color	Code	Price	
White	PC4	+ \$0	
Black	PC1	+ \$0	

10. Monitor Arm

Product Type	Code	Price	
King Cobra Monitor Arm	3101	Priced by Style	
Unity G2 Monitor Arm	3111	Priced by Style	
Mobio Monitor Arm	3210	Priced by Style	
Product Style	Code	Price	
King Cobra			
Single Screen Light Duty	MAT01	+ \$495	
Single Screen Heavy Duty	MAT02	+ \$520	
Dual Screen Array Heavy Duty	MAT03	+ \$580	
Dual Screen High-Splitter Heavy Duty	MAT04	+ \$725	

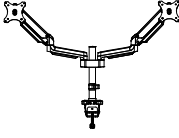
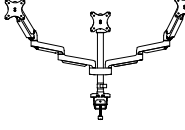
SWITCHBACK

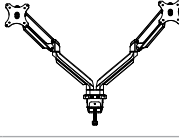
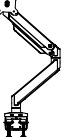
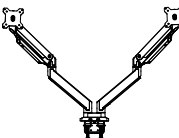
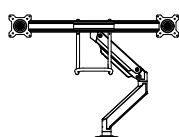
10. Monitor Arm (Cont.)

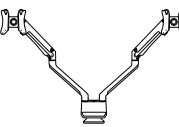
Product Style	Code	Price	
Mobio			
Single Pole	MAT30	\$309	
Dual Pole	MAT31	\$557	
Triple Pole	MAT32	\$646	
Single Desk	MAT33	\$243	
Dual Desk	MAT34	\$485	
Heavy Duty Single Desk	MAT35	\$378	
Heavy Duty Dual Desk	MAT36	\$849	
Heavy Duty Dual Array	MAT37	\$562	
Unity G2			
Single Monitor Arm	MAT06	\$249	
Dual Monitor Arm	MAT07	\$499	

SWITCHBACK BUNDLE

10. Monitor Arm (Cont.)

Paint Color	Code	Price	
Black	MAC03	+ \$0	
Silver	MAC01	+ \$0	
White	MAC02	+ \$0	

King Cobra and Mobio HD monitor arms are available in silver only. Black finish available on Mobio monitor arms only (not available on heavy duty models).

11. Mobile Pedestal

Product Type	Code	Price	
Mobile Pedestal	3150	Priced by Style	

Product Style	Code	Price	
---------------	------	-------	--

No Upholstered Pad CPT00 + \$283



Upholstered Pad CPT01 + \$393



Paint Color	Code	Price	
Silver	PDC01	+ \$0	
White	PDC02	+ \$0	

Fabric Grade (CPT01 Only)	Code	Price	
Grade 1	FG1	+ \$0	
Grade 2	FG2	+ \$11	
Grade 3	FG3	+ \$30	
Grade 4	FG4	+ \$52	
Grade 5	FG5	+ \$90	
Grade 6	FG6	+ \$127	
Grade 7	FG7	+ \$165	

Please reference the Textile Reference Guide for pricing on fabric over grade 7.

Switchback

2-LEG HEIGHT-ADJUSTABLE TABLE

Find your fit.

Achieving the perfect position maximizes ergonomics and minimizes fatigue or injury. With the press of a button, you can make Switchback height-adjustable table elevate the way you work while ensuring it matches your unique needs. Configure your Switchback with a variety of leg options and an extensive portfolio of tabletop shapes and workstation add-ons. All that and quick installation make Switchback a leading solution in simplicity and endless versatility.



3-Stage T-Leg

Chair sold separately; see page 80 for Focus 2.0

Featured Models

2-STAGE T-LEG :: \$966

2-Stage T-leg base, 24" x 60"
laminated top, no grommets

3-STAGE T-LEG :: \$1,063

3-Stage T-leg base, 30" x 60"
laminated top, no grommets

3-STAGE C-LEG :: \$1,122

3-Stage C-leg base, 30" x 72"
laminated top, no grommets

Features

- Gyro anti-collision technology from a patented sensor stops (and retracts) the table when it makes contact with any object
- Push-button controls with four user-customized positions
- Available with T-leg or C-leg options
- Twelve different durable laminate options to fit your style
- Three durable powder-coated metal base finishes in silver, black or white
- Optional grommets for easy and clean setup of electronic devices
- Chicago Code Compliant (3-conductor type cord with grounded 3-prong molded case plug)
- Meets G1 ANSI BIFMA Certification

SPECIFICATIONS

	3161 TBT6/ TBT6C 2-Stage Switchback	3161 TBT8/ TBT7C 3-Stage Switchback
Height Range	27.9"-47.625"	22.6"-48.7"
Foot Length With 24" Wide Tabletop	21.65" (T-Leg) 22.83" (C-Leg)	21.65" (T-Leg) 22.83" (C-Leg)
Foot Length With 30" Wide Tabletop	29.53"	29.53"
Tabletop Thickness	1.125"	1.125"
Adjustment Speed	1.22" Per Second	1.5" Per Second
Standby Power Consumption	<0.1W	<0.1W
Noise	Approximately 39 DB	Approximately 39 DB
Power Cord Length	98.5"	98.5"
Weight Capacity Warranty	220 lb	265 lb

Height range includes 1.125" tabletop.



3-Stage C-Leg
Chair sold separately; see page 185 for Wit.

1. Product

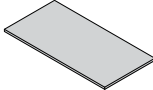
Product Type	Code	Price	
Rectangular Tabletop	3161	Priced by Size	

Product Style	Code	Price	
For 2-Stage T-Leg Base	TBT6	Priced by Size	
For 3-Stage T-Leg Base	TBT7	Priced by Size	
For 2-Stage C-Leg Base	TBT6C	Priced by Size	
For 3-Stage, C-Leg Base	TBT7C	Priced by Size	

2. Size

Tabletop Size (D x W)	Code	Price	
24" x 42"	TZ2442	\$166	
24" x 48"	TZ2448	\$189	
24" x 54"	TZ2454	\$213	
24" x 60"	TZ2460	\$236	
24" x 66"	TZ2466	\$261	
24" x 72"	TZ2472	\$284	
24" x 78"	TZ2478	\$308	
24" x 84"	TZ2484	\$331	
30" x 42"	TZ3042	\$208	
30" x 48"	TZ3048	\$236	
30" x 54"	TZ3054	\$266	
30" x 60"	TZ3060	\$295	
30" x 66"	TZ3066	\$325	
30" x 72"	TZ3072	\$354	
30" x 78"	TZ3078	\$384	
30" x 84"	TZ3084	\$414	

TABLETOP FOR 2-LEG BASE

TOPS AND BASES ARE SPECIFIED AND SOLD SEPARATELY.

3. Top Finish

Laminate	Code	Price	
Ankara Cherry	TL18	+ \$0	
Black	TL19	+ \$0	
Brazilian Walnut	TL20	+ \$0	
Cabinet Maple	TL21	+ \$0	
Contour White	TL22	+ \$0	
Driftwood	TL23	+ \$0	
Folkstone Grey	TL24	+ \$0	
Libretti	TL25	+ \$0	
Queenston Oak	TL26	+ \$0	
Sandalwood	TL27	+ \$0	
Walnut Amati	TL28	+ \$0	
White	TL29	+ \$0	

4. Grommets

Grommet Location	Code	Price	
None	GP00	+ \$0	
Left	GP01	+ \$30	
Center	GP02	+ \$30	
Right	GP03	+ \$30	
Left and Center	GP04	+ \$60	
Left and Right	GP05	+ \$60	
Right and Center	GP06	+ \$60	
Left, Right and Center	GP07	+ \$90	

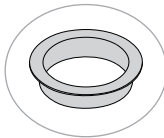

Grommet Color	Code	Price	
Black	GC01	+ \$0	
White	GC02	+ \$0	

SWITCHBACK

GSA SIN #: 33721

1. Product

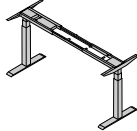
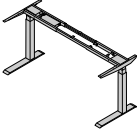
Product Type	Code	Price	
Switchback 2-Leg Base	3162	Priced by Style	
Product Style	Code	Price	
2-Stage T-Leg Base	TBT6	\$730	
3-Stage T-Leg Base	TBT7	\$768	
2-Stage C-Leg Base	TBT6C	\$730	
3-Stage C-Leg Base	TBT7C	\$768	

2. Size

Tabletop Size (D x W)	Code	Price	
24" x 42"	TZ2442	+ \$0	
24" x 48"	TZ2448	+ \$0	
24" x 54"	TZ2454	+ \$0	
24" x 60"	TZ2460	+ \$0	
24" x 66"	TZ2466	+ \$0	
24" x 72"	TZ2472	+ \$0	
24" x 78"	TZ2478	+ \$0	
24" x 84"	TZ2484	+ \$0	
30" x 42"	TZ3042	+ \$0	
30" x 48"	TZ3048	+ \$0	
30" x 54"	TZ3054	+ \$0	
30" x 60"	TZ3060	+ \$0	
30" x 66"	TZ3066	+ \$0	
30" x 72"	TZ3072	+ \$0	
30" x 78"	TZ3078	+ \$0	
30" x 84"	TZ3084	+ \$0	

Bases require the specification of a tabletop size. Bases take their size from their corresponding tabletop size.

2-LEG HEIGHT-ADJUSTABLE BASE

TOPS AND BASES ARE SPECIFIED AND SOLD SEPARATELY.

3. Base Finish

Paint Color	Code	Price	
Silver	BF01	+ \$0	
White	BF02	+ \$0	
Black	BF03	+ \$0	

4. Feet

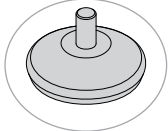
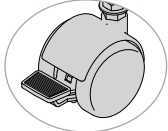
Foot Style	Code	Price	
Glides	LS18	+ \$0	
Casters	LS19	+ \$109	

Switchback

3-LEG HEIGHT-ADJUSTABLE TABLE TYPICALS

Find your fit. Achieving the perfect position maximizes ergonomics and minimizes fatigue or injury. With the press of a button, you can make the Switchback height-adjustable table elevate the way you work while ensuring it matches your unique needs. Configure your height-adjustable table with a variety of leg options and an extensive portfolio of top shapes and workstation add-ons. All that and quick installation make Switchback a leading solution in simplicity and endless versatility.



T-Shape Collaborative



U-Shape



Pod



Extended Offset U-Shape



Extended Offset Corner With Return

1. Pod Typical

Category	Code	Quantity	Description	List Price	Ext. Price	
Tabletop	3161 TBT8C TA2448 TL27 GP00	3	120-Degree Tabletop: 24" x 48", Laminate, No Grommets	\$666	\$1,998	
Table Base	3162 TBT8C TA2448 BF01	3	3-Leg Base (Pairs With 24" x 48" 120-Degree Tabletop)	\$1,426	\$4,278	

TOTAL: \$6,273

2. U-Shape Typical

Category	Code	Quantity	Description	List Price	Ext. Price	
Tabletop	3161 TBT8C TBCR2448 TL27 GP00	1	Right 90-Degree Tabletop: 24" x 48", Laminate, No Grommets	\$414	\$414	
Tabletop	3161 TBT8C TBCL2448 TL27 GP00	1	Left 90-Degree Tabletop: 24" x 48", Laminate, No Grommets	\$414	\$414	
Table Base	3162 TBT8C TBCL2448 BF01	1	3-Leg Base (Pairs With 24" x 48" 90-Degree Left Tabletop)	\$1,426	\$1,426	
Table Base	3162 TBT8C TBCR2448 BF01	1	3-Leg Base (Pairs With 24" x 48" 90-Degree Right Tabletop)	\$1,426	\$1,426	

TOTAL: \$3,680

3. Extended Offset U-Shape Typical

Category	Code	Quantity	Description	List Price	Ext. Price	
Tabletop	3161 TBT8C OR24367230 TL27 GP00	1	Right Extended Offset Corner Tabletop: 24" x 36" x 72" x 30", Laminate, No Grommets	\$549	\$549	
Tabletop	3161 TBT8C OL30723624 TL27 GP00	1	Left Extended Offset Corner Tabletop: 30" x 72" x 36" x 24", Laminate, No Grommets	\$549	\$549	
Return Top	3164 TBT8C TN2436 TL27 GP00	2	Return Top: 24" x 36", Laminate, No Grommets	\$142	\$284	
Table Base	3162 TBT8C TBCR3048 TN2436 BF01	1	3-Leg Base (Pairs With 24" x 36" x 72" x 30" Right Extended Offset Corner Tabletop)	\$1,650	\$1,650	
Table Base	3162 TBT8C TBCL3048 TN2436 BF01	1	3-Leg Base (Pairs With 30" x 72" x 36" x 24" Left Extended Offset Corner Tabletop)	\$1,650	\$1,650	

TOTAL: \$4,682

4. Extended Offset Corner With Return Typical

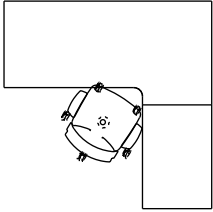
Category	Code	Quantity	Description	List Price	Ext. Price	
Tabletop	3161 TBT8C OL30723624 TL27 GP00	1	Left Extended Offset Corner Tabletop: 24" x 36" x 72" x 30", Laminate, No Grommets	\$549	\$549	
Return Top	3164 TBT8C TN2436 TL27 GP00	1	Return Top: 24" x 36", Laminate, No Grommets	\$142	\$142	
Table Base	3162 TBT8C TBCL2448 TN2436 BF01	1	3-Leg Base (Pairs With 24" x 36" x 72" x 30" Left Extended Corner Tabletop)	\$1,650	\$1,650	

TOTAL: \$2,341

5. T-Shape Collaborative Typical

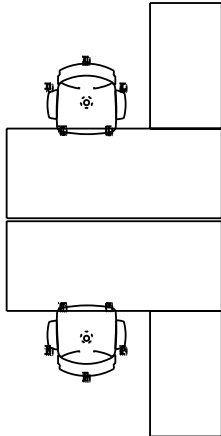
Category	Code	Quantity	Description	List Price	Ext. Price	
Tabletop	3161 TBT8C TZ3072 TL27 GP00	2	Rectangular Tabletop: 30" x 72", Laminate, No Grommets	\$354	\$708	
Return Top	3164 TBT8C TN2442 TL27 GP00	2	Return Top: 24" x 42", Laminate, No Grommets	\$166	\$332	
Table Base	3162 TBT8C TZ3072 TN2442 BF01	2	3-Leg Base (Pairs With 30" x 72" Tabletop and Return)	\$1,650	\$3,300	

TOTAL: \$4,340

Switchback

3-LEG HEIGHT-ADJUSTABLE TABLE

Find your fit.

Achieving the perfect position maximizes ergonomics and minimizes fatigue or injury. With the press of a button, you can make the Switchback height-adjustable table elevate the way you work while ensuring it matches your unique needs. Configure your Switchback with a variety of leg options and an extensive portfolio of tabletop shapes and workstation add-ons. All that and quick installation make Switchback a leading solution in simplicity and endless versatility.



*3-Leg 120-Degree
Chair sold separately;
see page 169 for Vectra*

Featured Models

3-LEG 90° :: \$1942

3-leg base with 24" x 60"
90° corner tabletop

3-LEG 120° :: \$2,092

3-leg base with 24" x 48"
120° tabletop

3-LEG EXTENDED :: \$2,390

3-leg base with 24" x 48" x 72" right
extended corner tabletop,
24" x 24" return top

3-LEG HEIGHT-ADJUSTABLE TABLE

TOPS AND BASES ARE SPECIFIED AND SOLD SEPARATELY.

Features

- Gyro anti-collision technology from a patented sensor stops (and retracts) the table when it makes contact with any object
- Push-button controls with four user-customized positions
- C-leg base
- Twelve different durable laminate options to fit your style
- Three durable powder-coated metal finishes in silver, black or white
- Optional grommets for easy and clean setup of electronic devices
- Chicago Code Compliant (3-conductor type cord with grounded 3-prong molded case plug)
- Meets G1 ANSI BIFMA Certification

SPECIFICATIONS

	C-Leg Switchback
Height Range	22.6"-48.7"
Foot Length With 24" Wide Tabletop	22.83"
Foot Length With 30" Wide Tabletop	29.53"
Tabletop Thickness	1.125"
Adjustment Speed	1.5" Per Second
Standby Power Consumption	<0.1W
Noise	Approximately 39 DB
Power Cord Length	98.5"
Weight Capacity Warranty	265 lb

Height range includes 1.125" tabletop.



*3-Leg Extended Corner
Chair sold separately;
see page 126 for Novo.*

SWITCHBACK

GSA SIN #: 33721

1. Product

Product Type	Code	Price	
Tabletop	3161	Priced by Size	
Product Style	Code	Price	
For Switchback 3-Leg 3-Stage C-Leg Base	TBT8C	Priced by Size	

2. Size

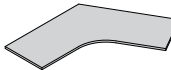
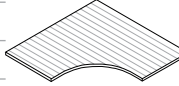
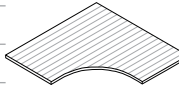
Tabletop Size (D x W)	Code	Price	
120-Degree Tabletop			
24" x 42"	TA2442	\$517	
24" x 48"	TA2448	\$666	
30" x 42"	TA3042	\$540	
30" x 48"	TA3048	\$673	
Tabletop Size (D x W)	Code	Price	
Right 90-Degree Corner Tabletop			
24" x 48" Right	TBCR2448	\$414	
24" x 54" Right	TBCR2454	\$466	
24" x 60" Right	TBCR2460	\$516	
30" x 48" Right	TBCR3048	\$516	
30" x 54" Right	TBCR3054	\$584	
30" x 60" Right	TBCR3060	\$646	
Left 90-Degree Corner Tabletop			
24" x 48" Left	TBCL2448	\$414	
24" x 54" Left	TBCL2454	\$466	
24" x 60" Left	TBCL2460	\$516	
30" x 48" Left	TBCL3048	\$516	
30" x 54" Left	TBCL3054	\$584	
30" x 60" Left	TBCL3060	\$646	

1-PIECE TABLETOP FOR 3-LEG BASE TOPS AND BASES ARE SPECIFIED AND SOLD SEPARATELY.

3. Top Finish

Laminate	Code	Price	
Ankara Cherry	TL18	+ \$0	
Black	TL19	+ \$0	
Brazilian Walnut	TL20	+ \$0	
Cabinet Maple	TL21	+ \$0	
Contour White	TL22	+ \$0	
Driftwood	TL23	+ \$0	
Folkstone Grey	TL24	+ \$0	
Libretti	TL25	+ \$0	
Queenston Oak	TL26	+ \$0	
Sandalwood	TL27	+ \$0	
Walnut Amati	TL28	+ \$0	
White	TL29	+ \$0	

4. Grommets

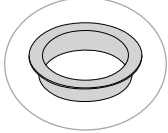
Grommet Location	Code	Price	
None	GP00	+ \$0	
Left	GP01	+ \$30	
Center	GP02	+ \$30	
Right	GP03	+ \$30	
Left and Center	GP04	+ \$60	
Left and Right	GP05	+ \$60	
Right and Center	GP06	+ \$60	
Left, Right and Center	GP07	+ \$90	
Grommet Color	Code	Price	
Black	GC01	+ \$0	
White	GC02	+ \$0	

SWITCHBACK

GSA SIN #: 33721

1. Product

Product Type	Code	Price	
Switchback 3-Leg Base	3162	Priced by Style	

Product Style	Code	Price	
3-Stage C-Leg Base	TBT8C	\$1,426	

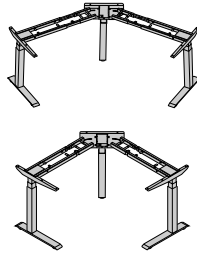

2. Size

Tabletop Size	Code	Price	
Depth x Width	120-Degree Top		
24" x 42"	TA2442	+ \$0	
24" x 48"	TA2448	+ \$0	
30" x 42"	TA3042	+ \$0	
30" x 48"	TA3048	+ \$0	

3-LEG BASE FOR 1-PIECE TOP

TOPS AND BASES ARE SPECIFIED AND SOLD SEPARATELY.

2. Size (Cont.)

Tabletop Size	Code	Price	
Depth x Width	Right 90-Degree Corner Tabletop		
24" x 48"	TBCR2448	+ \$0	
24" x 54"	TBCR2454	+ \$0	
24" x 60"	TBCR2460	+ \$0	
30" x 48"	TBCR3048	+ \$0	
30" x 54"	TBCR3054	+ \$0	
30" x 60"	TBCR3060	+ \$0	
Depth x Width	Left 90-Degree Corner Tabletop		
24" x 48"	TBCL2448	+ \$0	
24" x 54"	TBCL2454	+ \$0	
24" x 60"	TBCL2460	+ \$0	
30" x 48"	TBCL3048	+ \$0	
30" x 54"	TBCL3054	+ \$0	
30" x 60"	TBCL3060	+ \$0	

Bases require the specification of a tabletop size. Bases take their size from their corresponding tabletop size.

3. Base Finish

Paint Color	Code	Price	
Silver	BF01	+ \$0	
White	BF02	+ \$0	
Black	BF03	+ \$0	



3-Leg 120°
Chair sold separately;
see page 169 for Vectra

SWITCHBACK

GSA SIN #: 33721

1. Product

Product Type	Code	Price	
Switchback Tabletop	3161	Priced by Size	
Product Style	Code	Price	
For Switchback 3-Leg 3-Stage C-Leg Base	TBT8C	Priced by Size	

2. Size

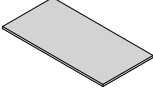
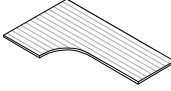
Tabletop Size	Code	Price		
Depth x Width	Rectangular Tabletop			
24" x 48"	TZ2448	\$189		
24" x 54"	TZ2454	\$213		
24" x 60"	TZ2460	\$236		
24" x 66"	TZ2466	\$261		
24" x 72"	TZ2472	\$284		
30" x 48"	TZ3048	\$208		
30" x 54"	TZ3054	\$236		
30" x 60"	TZ3060	\$266		
30" x 66"	TZ3066	\$295		
30" x 72"	TZ3072	\$325		
Right A x B x C	Extended Corner Tabletop			
24" x 36" x 60"	TXR243660	\$388		
24" x 36" x 66"	TXR243666	\$438		
24" x 36" x 72"	TXR243672	\$495		
24" x 42" x 60"	TXR244260	\$446		
24" x 42" x 66"	TXR244266	\$504		
24" x 42" x 72"	TXR244272	\$569		
24" x 48" x 60"	TXR244860	\$490		
24" x 48" x 66"	TXR244866	\$554		
24" x 48" x 72"	TXR244872	\$626		
30" x 36" x 60"	TXR303660	\$446		
30" x 36" x 66"	TXR303666	\$504		
30" x 36" x 72"	TXR303672	\$609		
30" x 42" x 60"	TXR304260	\$513		
30" x 42" x 66"	TXR304266	\$579		
30" x 42" x 72"	TXR304272	\$655		
30" x 48" x 60"	TXR304860	\$539		
30" x 48" x 66"	TXR304866	\$609		
30" x 48" x 72"	TXR304872	\$689		

TABLETOP FOR 3-LEG BASE AND RETURN

TOPS AND BASES ARE SPECIFIED AND SOLD SEPARATELY.

2. Size (Cont.)

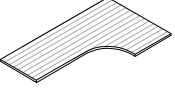
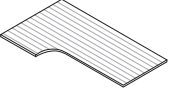
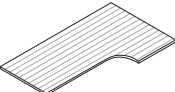
Tabletop Size (Cont.)	Code	Price	
Left A x B x C	Extended Corner Tabletop		
24" x 60" x 36"	TXL246036	\$388	
24" x 66" x 36"	TXL246636	\$438	
24" x 72" x 36"	TXL247236	\$495	
24" x 60" x 42"	TXL246042	\$446	
24" x 66" x 42"	TXL246642	\$504	
24" x 72" x 42"	TXL247242	\$569	
24" x 60" x 48"	TXL246048	\$490	
24" x 66" x 48"	TXL246648	\$554	
24" x 72" x 48"	TXL247248	\$626	
30" x 60" x 48"	TXL306048	\$446	
30" x 66" x 36"	TXL306636	\$504	
30" x 72" x 36"	TXL307236	\$609	
30" x 60" x 42"	TXL306042	\$513	
30" x 66" x 42"	TXL306642	\$579	
30" x 72" x 42"	TXL307242	\$655	
30" x 60" x 48"	TXL306048	\$539	
30" x 66" x 48"	TXL306648	\$609	
30" x 72" x 48"	TXL307248	\$689	
Right A x B x C x D	Extended Offset Corner Top		
24" x 36" x 60" x 30"	OR24366030	\$426	
24" x 36" x 66" x 30"	OR24366630	\$484	
24" x 36" x 72" x 30"	OR24367230	\$549	
24" x 42" x 60" x 30"	OR24426030	\$493	
24" x 42" x 66" x 30"	OR24426630	\$559	
24" x 42" x 72" x 30"	OR24427230	\$635	
24" x 48" x 60" x 30"	OR24486030	\$519	
24" x 48" x 66" x 30"	OR24486630	\$589	
24" x 48" x 72" x 30"	OR24487230	\$669	
Left A x B x C x D	Extended Offset Corner Top		
30" x 60" x 36" x 24"	OL30603624	\$426	
30" x 66" x 36" x 24"	OL30663624	\$484	
30" x 72" x 36" x 24"	OL30723624	\$549	
30" x 60" x 42" x 24"	OL30604224	\$493	
30" x 66" x 42" x 24"	OL30664224	\$559	
30" x 72" x 42" x 24"	OL30724224	\$635	
30" x 60" x 48" x 24"	OL30604824	\$519	
30" x 66" x 48" x 24"	OL30664824	\$589	
30" x 72" x 48" x 24"	OL30724824	\$669	

On extended corner tops, the main desk and return have equal depth.

On extended offset corner tops, the main desk has a depth of 30", which tapers down to a depth of 24" on the return.

Multipiece tops must be paired with returns. See the diagram on the following page for more information on extended corner dimensions.

SWITCHBACK

GSA SIN #: 33721

TABLETOP FOR 3-LEG BASE AND RETURN

TOPS AND BASES ARE SPECIFIED AND SOLD SEPARATELY.

3. Top Finish

Laminate	Code	Price
Ankara Cherry	TL18	+ \$0
Black	TL19	+ \$0
Brazilian Walnut	TL20	+ \$0
Cabinet Maple	TL21	+ \$0
Contour White	TL22	+ \$0
Driftwood	TL23	+ \$0
Folkstone Grey	TL24	+ \$0
Libretti	TL25	+ \$0
Queenston Oak	TL26	+ \$0
Sandalwood	TL27	+ \$0
Walnut Amati	TL28	+ \$0
White	TL29	+ \$0

4. Grommets

Grommet Location	Code	Price
None	GP00	+ \$0
Left	GP01	+ \$30
Center	GP02	+ \$30
Right	GP03	+ \$30
Left and Center	GP04	+ \$60
Left and Right	GP05	+ \$60
Right and Center	GP06	+ \$60
Left, Right and Center	GP07	+ \$90

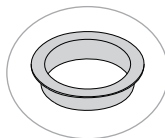

Grommet Color	Code	Price
Black	GC01	+ \$0
White	GC02	+ \$0

Left grommets (GP01/GP04/GP05/GP07) are not available on right extended corners or right extended offset corners.

Right grommets (GP03/GP05/GP06/GP07) are not available on left extended corners or left extended offset corners.

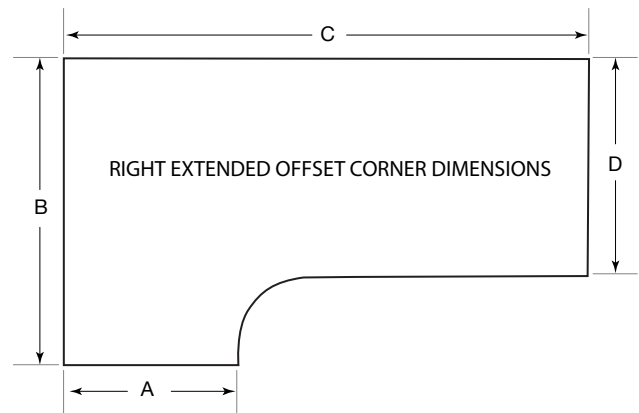
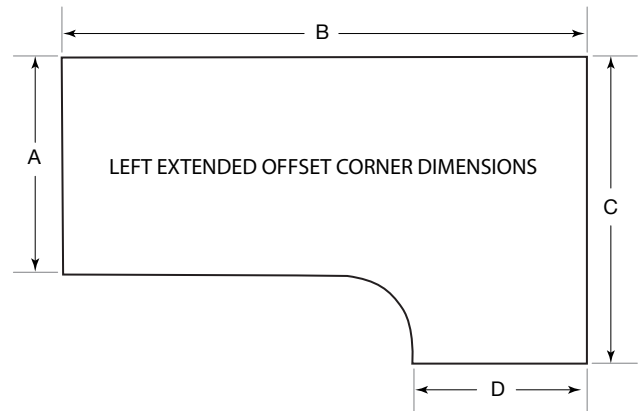

SWITCHBACK

GSA SIN #: 33721

1. Product

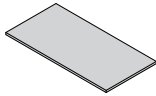
Product Type	Code	Price	
Return Top	3164	Priced by Size	
Product Style	Code	Price	
For Switchback 3-Leg 3-Stage C-Leg Base	TBT8C	Priced by Size	

2. Size

Return Top Size (D x W)	Code	Price	
24" x 24"	TN2424	\$114	
24" x 30"	TN2430	\$131	
24" x 36"	TN2436	\$142	
24" x 42"	TN2442	\$166	
24" x 48"	TN2448	\$189	
30" x 24"	TN3024	\$137	
30" x 30"	TN3030	\$163	
30" x 36"	TN3036	\$178	
30" x 42"	TN3042	\$208	

3. Tabletop Finish

Laminate	Code	Price	
Ankara Cherry	TL18	+ \$0	
Black	TL19	+ \$0	
Brazilian Walnut	TL20	+ \$0	
Cabinet Maple	TL21	+ \$0	
Contour White	TL22	+ \$0	
Driftwood	TL23	+ \$0	
Folkstone Grey	TL24	+ \$0	
Libretti	TL25	+ \$0	
Queenston Oak	TL26	+ \$0	
Sandalwood	TL27	+ \$0	
Walnut Amati	TL28	+ \$0	
White	TL29	+ \$0	

RETURN TOP FOR 3-LEG BASE

TOPS AND BASES ARE SPECIFIED AND SOLD SEPARATELY.

4. Grommets

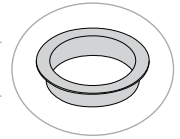
Grommet Location	Code	Price	
None	GPR00	+ \$0	
Left	GPR01	+ \$30	
Center	GPR02	+ \$30	
Right	GPR03	+ \$30	
Grommet Color	Code	Price	
Black	GC01	+ \$0	
White	GC02	+ \$0	

SWITCHBACK

GSA SIN #: 33721

1. Base

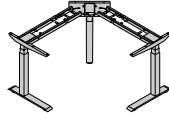
Product Type	Code	Base	
3-Leg 3-Stage C-Leg Base	3162 TBT8C	\$1,426	

2. Size

Tabletop Size	Code	Price	
Depth x Width	Rectangular Tabletop		
24" x 48"	TZ2448	+ \$0	
24" x 54"	TZ2454	+ \$0	
24" x 60"	TZ2460	+ \$0	
24" x 66"	TZ2466	+ \$0	
24" x 72"	TZ2472	+ \$0	
30" x 48"	TZ3048	+ \$0	
30" x 54"	TZ3054	+ \$0	
30" x 60"	TZ3060	+ \$0	
30" x 66"	TZ3066	+ \$0	
30" x 72"	TZ3072	+ \$0	
Right A x B x C	Extended Corner Tabletop		
24" x 36" x 60"	TXR243660	+ \$0	
24" x 36" x 66"	TXR243666	+ \$0	
24" x 36" x 72"	TXR243672	+ \$0	
24" x 42" x 60"	TXR244260	+ \$0	
24" x 42" x 66"	TXR244266	+ \$0	
24" x 42" x 72"	TXR244272	+ \$0	
24" x 48" x 60"	TXR244860	+ \$0	
24" x 48" x 66"	TXR244866	+ \$0	
24" x 48" x 72"	TXR244872	+ \$0	
30" x 36" x 60"	TXR303660	+ \$0	
30" x 36" x 66"	TXR303666	+ \$0	
30" x 36" x 72"	TXR303672	+ \$0	
30" x 42" x 60"	TXR304260	+ \$0	
30" x 42" x 66"	TXR304266	+ \$0	
30" x 42" x 72"	TXR304272	+ \$0	
30" x 48" x 60"	TXR304860	+ \$0	
30" x 48" x 66"	TXR304866	+ \$0	
30" x 48" x 72"	TXR304872	+ \$0	

3-LEG BASE FOR TABLETOP AND RETURN TOPS AND BASES ARE SPECIFIED AND SOLD SEPARATELY.

2. Size (Cont.)

Tabletop Size	Code	Price	
Left A x B x C	Extended Corner Tabletop		
24" x 60" x 36"	TXL246036	+ \$0	
24" x 66" x 36"	TXL246636	+ \$0	
24" x 72" x 36"	TXL247236	+ \$0	
24" x 60" x 42"	TXL246042	+ \$0	
24" x 66" x 42"	TXL246642	+ \$0	
24" x 72" x 42"	TXL247242	+ \$0	
24" x 60" x 48"	TXL246048	+ \$0	
24" x 66" x 48"	TXL246648	+ \$0	
24" x 72" x 48"	TXL247248	+ \$0	
30" x 60" x 48"	TXL306036	+ \$0	
30" x 66" x 36"	TXL306636	+ \$0	
30" x 72" x 36"	TXL307236	+ \$0	
30" x 60" x 42"	TXL306042	+ \$0	
30" x 66" x 42"	TXL306642	+ \$0	
30" x 72" x 42"	TXL307242	+ \$0	
30" x 60" x 48"	TXL306048	+ \$0	
30" x 66" x 48"	TXL306648	+ \$0	
30" x 72" x 48"	TXL307248	+ \$0	
Right A x B x C x D	Extended Offset Corner Top		
24" x 36" x 60" x 30"	OR24366030	+ \$0	
24" x 36" x 66" x 30"	OR24366630	+ \$0	
24" x 36" x 72" x 30"	OR24367230	+ \$0	
24" x 42" x 60" x 30"	OR24426030	+ \$0	
24" x 42" x 66" x 30"	OR24426630	+ \$0	
24" x 42" x 72" x 30"	OR24427230	+ \$0	
24" x 48" x 60" x 30"	OR24486030	+ \$0	
24" x 48" x 66" x 30"	OR24486630	+ \$0	
24" x 48" x 72" x 30"	OR24487230	+ \$0	
Left A x B x C x D	Extended Offset Corner Top		
30" x 60" x 36" x 24"	OL30603624	+ \$0	
30" x 66" x 36" x 24"	OL30663624	+ \$0	
30" x 72" x 36" x 24"	OL30723624	+ \$0	
30" x 60" x 42" x 24"	OL30604224	+ \$0	
30" x 66" x 42" x 24"	OL30664224	+ \$0	
30" x 72" x 42" x 24"	OL30724224	+ \$0	
30" x 60" x 48" x 24"	OL30604824	+ \$0	
30" x 66" x 48" x 24"	OL30664824	+ \$0	
30" x 72" x 48" x 24"	OL30724824	+ \$0	

Bases require the specification of a tabletop size. Bases take their size from their corresponding tabletop size.

3. Return Size

Return Top Size	Code	Price
No Return	TN0	+ \$0
24" x 24"	TN2424	+ \$74
24" x 30"	TN2430	+ \$74
24" x 36"	TN2436	+ \$74
24" x 42"	TN2442	+ \$74
24" x 48"	TN2448	+ \$74
30" x 24"	TN3024	+ \$74
30" x 30"	TN3030	+ \$74
30" x 36"	TN3036	+ \$74
30" x 42"	TN3042	+ \$74

4. Base Finish

Paint Color	Code	Price
Silver	BF01	+ \$0
White	BF02	+ \$0
Black	BF03	+ \$0

5. Base Extension

Parts	Code	Price
Cross Beam and Extension Cable	No Code	+ \$150

A base extension charge will be added automatically if the A or D measurement is equal to 72".

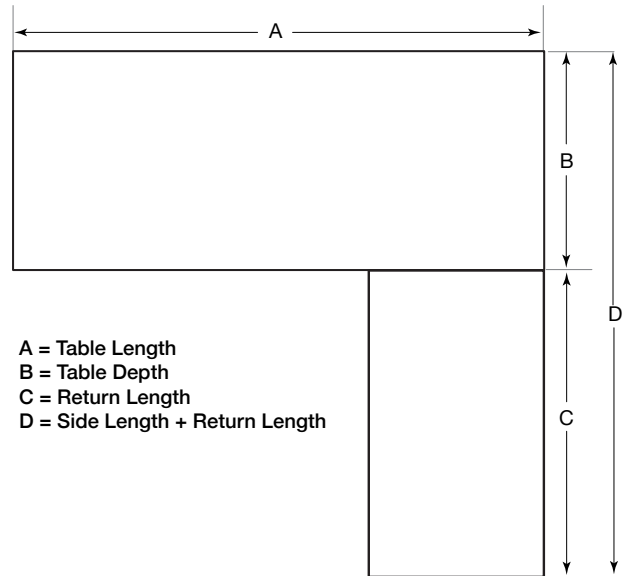
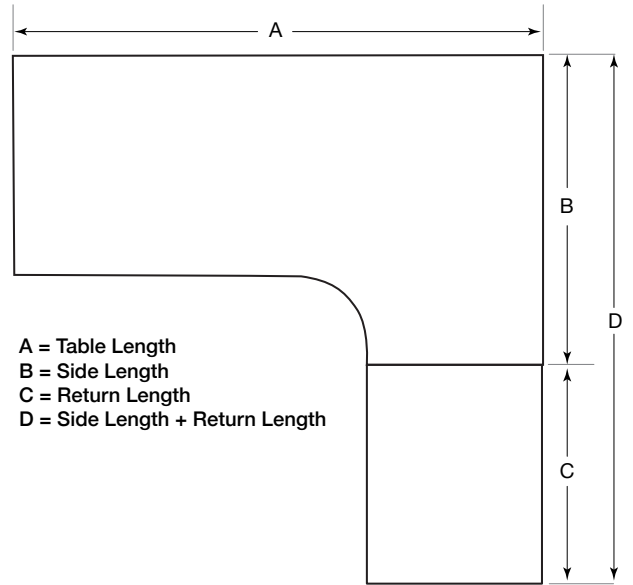

Tensor

CAFÉ, CLASSROOM, AND OFFICE TYPICALS

As your business grows and changes, your workspace should be able to keep up. That's why we created Tensor—one table that can adapt to your changing needs. It's the only table that can expand to support multiple tops on a single base. This allows you to install and reconfigure to fit any space quickly and easily.



L-Shaped With Main and Return



Conference



U-Shaped With Bridge



Multipurpose U-Shape





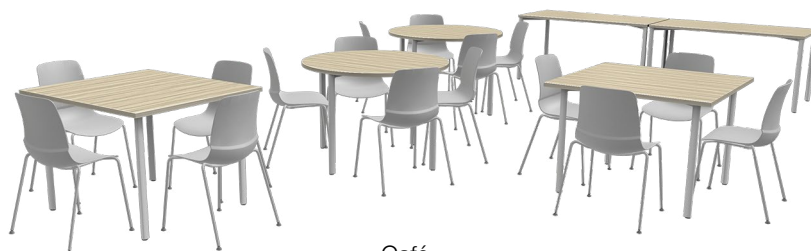



Classroom-Style Training

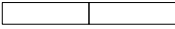

Café

1. Café Typical

Category	Code	Quantity	Description	List Price	Ext Price	
Tabletop	3231 TBT9 TZ1872 TL27 GP00	2	Rectangular Tabletop: 18" x 72", Laminate, No Grommets	\$239	\$478	
Tabletop	3231 TBT9 TS4242 TL27	2	Square Tabletop: 42" x 42", Laminate	\$287	\$574	
Tabletop	3231 TBT9 TR4242 TL27	2	Round Tabletop: 42" x 42", Laminate	\$330	\$660	
Table Base	3232 TBT9 TZ1872 BF01	2	Base (Pairs With Rectangular 18" x 72" Tabletop)	\$470	\$940	
Table Base	3232 TBT9 TS4242 BF01	2	Base (Pairs With 42" x 42" Square Tabletop)	\$415	\$830	
Table Base	3232 TBT9 TR4242 BF01	2	Base (Pairs With 42" x 42" Round Tabletop)	\$415	\$830	

TOTAL: \$4,312

2. Classroom-Style Training Typical

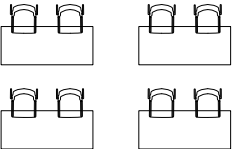
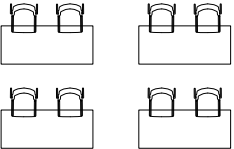
Category	Code	Quantity	Description	List Price	Ext Price	
Tabletop	3231 TBT9 TZ3072 TL24 GP00	8	Rectangular Tabletop: 30" x 72", Laminate, No Grommets	\$387	\$3,096	
Table Base	3232 TBT9 TZ3072 BF01	8	Base (Pairs With 30" x 72" Rectangular Tabletop)	\$470	\$3,760	

TOTAL: \$6,856

3. Multipurpose U-Shape Typical

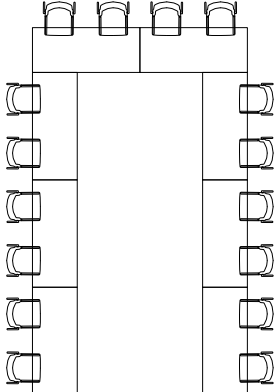
Category	Code	Quantity	Description	List Price	Ext Price	
Tabletop	3231 TBT9 TZ3072 TL22 GP00	8	Rectangular Tabletop: 30" x 72", Laminate, No Grommets	\$387	\$3,096	
Table Base	3232 TBT9 TZ3072 BF01	8	Base (Pairs With 30" x 72" Rectangular Tabletop)	\$470	\$3,760	
Accessories	3159 ATC03 XGV	7	Set of Two Ganging Brackets	\$37	\$259	

TOTAL: \$7,115

4. Conference Typical

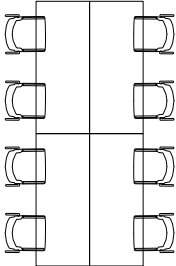
Category	Code	Quantity	Description	List Price	Ext Price	
Tabletop	3231 TBT9 TZ2460 TL27 GP00	4	Rectangular Tabletop: 24" x 60", Laminate, No Grommets	\$258	\$1,032	
Table Base	3232 TBT9 TZ2460 BF01	4	Base (Pairs With 24" x 60" Rectangular Tabletop)	\$450	\$1,800	
Accessories	3159 ATC03 XGV	4	Set of Two Ganging Brackets	\$37	\$148	

TOTAL: \$2,980

5. L-Shape Typical With Main Desk and Return

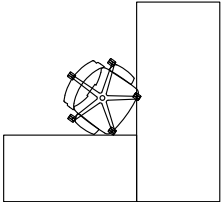
Category	Code	Quantity	Description	List Price	Ext Price	
Tabletop	3231 TBT9 TZ3072 TL27 GP00	1	Rectangular Tabletop: 30" x 72", Laminate, No Grommets	\$387	\$387	
Return Top	3231 TBT9P TN2448 TL27 GPR00	1	Return Top: 24" x 48", Laminate, No Grommets	\$207	\$207	
Table Base	3232 TBT9 TZ3072 BF01	1	Base (Pairs With 30" x 72" Rectangular Tabletop)	\$470	\$470	
Return Base	3232 TBT9P TN2448 BF01	1	Return Base (Pairs With 24" x 48" Return Top)	\$225	\$225	

TOTAL: \$1,289

6. U-Shape Typical With Bridge

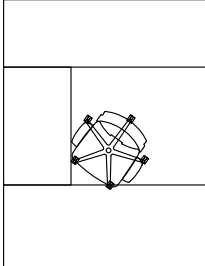
Category	Code	Quantity	Description	List Price	Ext Price	
Desktop	3231 TBT9 TZ3072 TL27 GP00	1	Rectangular Desktop: 30" x 72", Laminate, No Grommets	\$387	\$387	
Credenza Top	3231 TBT9 TZ2472 TL27 GP00	1	Rectangular Credenza Top: 24" x 72", Laminate, No Grommets	\$311	\$311	
Bridgetop	3231 TBT10 TZ2442 TL27	1	Bridgetop: 24" x 42", Laminate	\$182	\$182	
Desk Base	3232 TBT9 TZ3072 BF01	1	Base (Pairs With 30" x 72" Rectangular Tabletop)	\$470	\$470	
Credenza Base	3232 TBT9 TZ2472 BF01	1	Base (Pairs With 24" x 72" Rectangular Tabletop)	\$470	\$470	
Bridge Support	3232 TBT10 TZ2442	1	Mending Brackets (Pairs With 24" x 42" Bridgetop)	\$148	\$148	

TOTAL: \$1,968

Tensor

CAFÉ TABLE

One table does it all.

As your business grows and changes, your workspace should be able to keep up. That's why we created Tensor—one table that can adapt to your changing needs. It's the only table that can expand to support multiple top shapes and sizes with a single base. This allows you to install and reconfigure to fit any space quickly and easily.



Round Café Table
Chairs not included, see page 199 for Baja .

Featured Models

SQUARE :: \$702

42" square tabletop and matching base

ROUND :: \$745

42" round tabletop and matching base

Features

- Patent-pending easy-to-size table support structure adapts to all spaces
- Steel dual-isosceles triangle design evenly distributes and supports weight throughout
- Base accommodates round and square tabletops
Round from 42"–48"; Square from 30"–48"
- Features a minimalistic aesthetic with a below-the-surface configuration
- Assembles in less than 10 minutes with pre-installed parts
- 300 lb weight capacity warranty

SPECIFICATIONS

	Tensor Café Table
Height	29.67"
Leg Width	1.8"
Tabletop Thickness	1.125"
Weight Capacity Warranty	300 lb

Height range includes 1.125" tabletop.

1. Product

Product Type	Code	Price
Tabletop	3231 TBT9	Priced by Size

2. Size

Tabletop Size	Code	Price
Round		
42"	TR4242	\$330
48"	TR4848	\$372
Square		
30"	TS3030	\$221
36"	TS3636	\$254
42"	TS4242	\$287
48"	TS4848	\$324

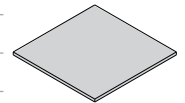
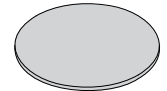

Actual size of 30" x 30" tabletop is 30.75" x 30.75".

3. Top Finish

Laminate	Code	Price
Ankara Cherry	TL18	+ \$0
Black	TL19	+ \$0
Brazilian Walnut	TL20	+ \$0
Cabinet Maple	TL21	+ \$0
Contour White	TL22	+ \$0
Driftwood	TL23	+ \$0
Folkstone Grey	TL24	+ \$0
Libretti	TL25	+ \$0
Queenston Oak	TL26	+ \$0
Sandalwood	TL27	+ \$0
Walnut Amati	TL28	+ \$0
White	TL29	+ \$0

CAFÉ TABLETOP

TOPS AND BASES ARE SPECIFIED AND SOLD SEPARATELY.

1. Product

Product Type	Code	Price
Base	3232 TBT9	\$415

2. Size

Tabletop Size	Code	Price
No Tabletop	TZ0	\$0

Round

42"	TR4242	+ \$0
48"	TR4848	+ \$0



Square

30"	TS3030	+ \$0
36"	TS3636	+ \$0
42"	TS4242	+ \$0
48"	TS4848	+ \$0

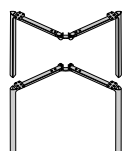

Table bases require the specification of a tabletop size. Bases take their size from their corresponding top size.

3. Base Finish

Paint Color	Code	Price
Silver	BF01	+ \$0
White	BF02	+ \$0
Black	BF03	+ \$0

Square Café Table

Chairs not included, see page 230 for Mika.



Tensor

MULTIPURPOSE TABLE

One table does it all.

As your business grows and changes, your workspace should be able to keep up. That's why we created Tensor—one table that can adapt to your changing needs. It's the only table that can expand to support multiple top shapes and sizes with a single base. This allows you to install and reconfigure to fit any space quickly and easily.



24" x 60" Table
Chairs not included, see page 222 for Ioniq Side.

Featured Models

18" x 48" :: \$609

18" x 48" laminate tabletop and matching base

24" x 60" :: \$708

24" x 60" laminate tabletop and matching base

30" x 72" :: \$857

30" x 72" laminate tabletop and matching base

Features

- Patent-pending easy-to-size table support structure adapts to all spaces
- Steel dual-isosceles triangle design evenly distributes and supports weight throughout
- Base accommodates tabletops from 18" (D) x 48" (W) to 30" (D) x 72" (W)
- Features a minimalistic aesthetic with a below-the-surface configuration
- Installs in less than 10 minutes with pre-installed parts
- 300 lb weight capacity warranty

1. Product

Product Type	Code	Price
Tabletop	3231 TBT9	Priced by Size

2. Size

Tabletop Size (D x W)	Code	Price
18" x 42"	TZ1842	\$140
18" x 48"	TZ1848	\$159
18" x 54"	TZ1854	\$179
18" x 60"	TZ1860	\$198
18" x 66"	TZ1866	\$220
18" x 72"	TZ1872	\$239
24" x 36"	TZ2436	\$156
24" x 42"	TZ2442	\$182
24" x 48"	TZ2448	\$207
24" x 54"	TZ2454	\$233
24" x 60"	TZ2460	\$258
24" x 66"	TZ2466	\$286
24" x 72"	TZ2472	\$311
30" x 36"	TZ3036	\$195
30" x 42"	TZ3042	\$228
30" x 48"	TZ3048	\$258
30" x 54"	TZ3054	\$292
30" x 60"	TZ3060	\$323
30" x 66"	TZ3066	\$356
30" x 72"	TZ3072	\$387

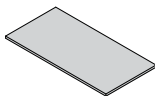

3. Top Finish

Laminate	Code	Price
Ankara Cherry	TL18	+ \$0
Black	TL19	+ \$0
Brazilian Walnut	TL20	+ \$0
Cabinet Maple	TL21	+ \$0
Contour White	TL22	+ \$0
Driftwood	TL23	+ \$0
Folkstone Grey	TL24	+ \$0
Libretti	TL25	+ \$0
Queenston Oak	TL26	+ \$0
Sandalwood	TL27	+ \$0
Walnut Amati	TL28	+ \$0
White	TL29	+ \$0

4. Grommets

Grommet Location	Code	Price
None	GP00	+ \$0
Left Only	GP01	+ \$30
Center Only	GP02	+ \$30
Right Only	GP03	+ \$30
Left and Center	GP04	+ \$60
Left and Right	GP05	+ \$60
Right and Center	GP06	+ \$60
Left, Right and Center	GP07	+ \$90

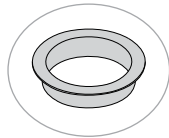

Grommet Color	Code	Price
Black	GC01	+ \$0
White	GC02	+ \$0

SPECIFICATIONS

	Tensor Multipurpose
Height	29.67"
Leg Width	1.8"
Tabletop Thickness	1.125"
Weight Capacity Warranty	300 lb

Height range includes 1.125" tabletop.

1. Product

Product Type	Code	Price
Table Base	3232 TBT9	\$415

2. Size

Tabletop Size (D x W)	Code	Price
18" x 42"	TZ1842	+ \$0
18" x 48"	TZ1848	+ \$35
18" x 54"	TZ1854	+ \$35
18" x 60"	TZ1860	+ \$35
18" x 66"	TZ1866	+ \$35
18" x 72"	TZ1872	+ \$55
24" x 36"	TZ2436	+ \$0
24" x 42"	TZ2442	+ \$0
24" x 48"	TZ2448	+ \$35
24" x 54"	TZ2454	+ \$35
24" x 60"	TZ2460	+ \$35
24" x 66"	TZ2466	+ \$35
24" x 72"	TZ2472	+ \$55
30" x 36"	TZ3036	+ \$0
30" x 42"	TZ3042	+ \$0
30" x 48"	TZ3048	+ \$35
30" x 54"	TZ3054	+ \$35
30" x 60"	TZ3060	+ \$35
30" x 66"	TZ3066	+ \$35
30" x 72"	TZ3072	+ \$55



Table bases require the specification of a tabletop size. Bases take their size from their corresponding top size.

3. Base Finish

Paint Color	Code	Price
Silver	BF01	\$0
White	BF02	\$0
Black	BF03	\$0

Tensor

DESKING

One table does it all.

As your business grows and changes, your workspace should be able to keep up. That's why we created Tensor—one table that can adapt to your changing needs. It's the only table that can expand to support multiple top shapes and sizes with a single base. This allows you to install and reconfigure to fit any space quickly and easily.



L-Shape Desk
Chair not included, see page 126 for Novo.

Featured Models

L-SHAPE DESK :: \$1,289

30" × 72" rectangular desktop, 24" × 48" return top, no grommets, matching bases

U-SHAPE DESK :: \$1,968

30" × 72" desktop, 24" × 72" credenza tops, no grommets, 24" × 42" bridgetop, matching bases and bridge support

Features

- Patent-pending easy-to-size table support structure adapts to all spaces
- Steel dual-isosceles triangle design evenly distributes and supports weight throughout
- Accommodates desktops from 24" x 54"-30" x 72"; credenzas from 18" x 54"-30" x 72"; 24" x 36"-60"
- Features a minimalistic aesthetic with a below-the-surface configuration
- Installs in less than 10 minutes with pre-installed parts
- 300 lb weight capacity warranty

SPECIFICATIONS

	Tensor Desking
Height	29.67"
Leg Width	1.8"
Tabletop Thickness	1.125"
Weight Capacity Warranty	300 lb

Height range includes 1.125" tabletop.



U-Shape Desk
 Chair not included, see page 126 for Novo.

DESKTOP AND DESK BASE FOR L-SHAPE OR U-SHAPE

TOPS AND BASES ARE SPECIFIED AND SOLD SEPARATELY.

1. Product

Product Type	Code	Price
Desktop	3231 TBT9	Priced by Size

2. Size

Desktop Size (D x W)	Code	Price
24" x 54"	TZ2454	\$233
24" x 60"	TZ2460	\$258
24" x 66"	TZ2466	\$286
24" x 72"	TZ2472	\$311
30" x 54"	TZ3054	\$292
30" x 60"	TZ3060	\$323
30" x 66"	TZ3066	\$356
30" x 72"	TZ3072	\$387

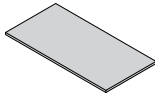

3. Top Finish

Laminate	Code	Price
Ankara Cherry	TL18	+ \$0
Black	TL19	+ \$0
Brazilian Walnut	TL20	+ \$0
Cabinet Maple	TL21	+ \$0
Contour White	TL22	+ \$0
Driftwood	TL23	+ \$0
Folkstone Grey	TL24	+ \$0
Libretti	TL25	+ \$0
Queenston Oak	TL26	+ \$0
Sandalwood	TL27	+ \$0
Walnut Amati	TL28	+ \$0
White	TL29	+ \$0

4. Grommets

Grommet Location	Code	Price
None	GP00	+ \$0
Left Only	GP01	+ \$30
Center Only	GP02	+ \$30
Right Only	GP03	+ \$30
Left and Center	GP04	+ \$60
Left and Right	GP05	+ \$60
Right and Center	GP06	+ \$60
Left, Right and Center	GP07	+ \$90

Grommet Color	Code	Price
Black	GC01	+ \$0
White	GC02	+ \$0

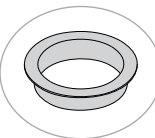

1. Desk Base

Product Type	Code	Price
Base	3232 TBT9	\$415

2. Size

Desktop Size (D x W)	Code	Price
24" x 54"	TZ2454	+ \$35
24" x 60"	TZ2460	+ \$35
24" x 66"	TZ2466	+ \$35
24" x 72"	TZ2472	+ \$55
30" x 54"	TZ3054	+ \$35
30" x 60"	TZ3060	+ \$35
30" x 66"	TZ3066	+ \$35
30" x 72"	TZ3072	+ \$55



Desk bases require the specification of a desktop size. Bases take their size from their corresponding top size.

3. Base Finish

Paint Color	Code	Price
Silver	BF01	\$0
White	BF02	\$0
Black	BF03	\$0

RETURN TOP AND RETURN BASE FOR L-SHAPE OR U-SHAPE

TOPS AND BASES ARE SPECIFIED AND SOLD SEPARATELY.

1. Product

Product Type	Code	Size
Return Top	3231 TBT9P	Priced by Size

2. Size

Return Top Size (D x W)	Code	Price
24" x 36"	TN2436	\$156
24" x 42"	TN2442	\$182
24" x 48"	TN2448	\$207
24" x 54"	TN2454	\$233
24" x 60"	TN2460	\$258

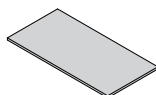

3. Top Finish

Laminate	Code	Price
Ankara Cherry	TL18	+ \$0
Black	TL19	+ \$0
Brazilian Walnut	TL20	+ \$0
Cabinet Maple	TL21	+ \$0
Contour White	TL22	+ \$0
Driftwood	TL23	+ \$0
Folkstone Grey	TL24	+ \$0
Libretti	TL25	+ \$0
Queenston Oak	TL26	+ \$0
Sandalwood	TL27	+ \$0
Walnut Amati	TL28	+ \$0
White	TL29	+ \$0

4. Grommets

Grommet Location	Code	Price
None	GPR00	+ \$0
Left Only	GPR01	+ \$30
Center Only	GPR02	+ \$30
Right Only	GPR03	+ \$30

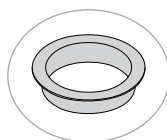

Grommet Color	Code	Price
Black	GC01	+ \$0
White	GC02	+ \$0

1. Product

Product Type	Code	Price
Return Base	3232 TBT9P	\$225

2. Size

Return Top Size (D x W)	Code	Price
No Return Top	TN0	+ \$0
24" x 36"	TN2436	+ \$0
24" x 42"	TN2442	+ \$0
24" x 48"	TN2448	+ \$0
24" x 54"	TN2454	+ \$74
24" x 60"	TN2460	+ \$74

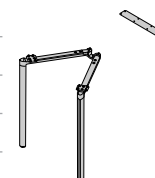

Return bases require the specification of a return top size.

3. Base Finish

Paint Color	Code	Price
Silver	BF01	\$0
White	BF02	\$0
Black	BF03	\$0

1. Product

Product Type	Code	Price
Bridgetop	3231 TBT10	Priced by Size

2. Size

Bridgetop Size (D x W)	Code	Price
24" x 36"	TZ2436	\$156
24" x 42"	TZ2442	\$182
24" x 48"	TZ2448	\$207
24" x 54"	TZ2454	\$233
24" x 60"	TZ2460	\$258

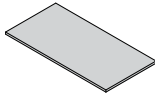

3. Top Finish

Laminate	Code	Price
Ankara Cherry	TL18	+ \$0
Black	TL19	+ \$0
Brazilian Walnut	TL20	+ \$0
Cabinet Maple	TL21	+ \$0
Contour White	TL22	+ \$0
Driftwood	TL23	+ \$0
Folkstone Grey	TL24	+ \$0
Libretti	TL25	+ \$0
Queenston Oak	TL26	+ \$0
Sandalwood	TL27	+ \$0
Walnut Amati	TL28	+ \$0
White	TL29	+ \$0

1. Product

Product Type	Code	Price
Bridge Support (Mending Brackets)	3232 TBT10	Priced by Size

2. Size

Bridgetop Size (D x W)	Code	Price
No Bridge Top	TN0	+ \$0
24" x 36"	TZ2436	\$148
24" x 42"	TZ2442	\$148
24" x 48"	TZ2448	\$148
24" x 54"	TZ2454	\$228
24" x 60"	TZ2460	\$228

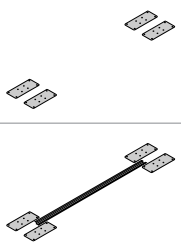

Support includes two sets of mending brackets for all bridge sizes. 54" and 60" table widths also include stiffener.

Bridge supports require the specification of a bridge top size.

1. Product

Product Type	Code	Price
Credenza Top	3231 TBT9	Priced by Size

2. Size

Credenza Top Size (D x W)	Code	Price
18" x 54"	TZ1854	+ \$179
18" x 60"	TZ1860	+ \$198
18" x 66"	TZ1866	+ \$220
18" x 72"	TZ1872	+ \$239
24" x 54"	TZ2454	+ \$233
24" x 60"	TZ2460	+ \$258
24" x 66"	TZ2466	+ \$286
24" x 72"	TZ2472	+ \$311
30" x 54"	TZ3054	+ \$292
30" x 60"	TZ3060	+ \$323
30" x 66"	TZ3066	+ \$356
30" x 72"	TZ3072	+ \$387

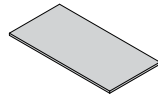

4. Grommets

Grommet Location	Code	Price
No Grommets	GP00	+ \$0
Left Only	GP01	+ \$30
Center Only	GP02	+ \$30
Right Only	GP03	+ \$30
Left and Center	GP04	+ \$60
Left and Right	GP05	+ \$60
Right and Center	GP06	+ \$60
Left, Right and Center	GP07	+ \$90

Grommet Color	Code	Price
Black	GC01	+ \$0
White	GC02	+ \$0

3. Top Finish

Laminate	Code	Price
Ankara Cherry	TL18	+ \$0
Black	TL19	+ \$0
Brazilian Walnut	TL20	+ \$0
Cabinet Maple	TL21	+ \$0
Contour White	TL22	+ \$0
Driftwood	TL23	+ \$0
Folkstone Grey	TL24	+ \$0
Libretti	TL25	+ \$0
Queenston Oak	TL26	+ \$0
Sandalwood	TL27	+ \$0
Walnut Amati	TL28	+ \$0
White	TL29	+ \$0

1. Product

Product Type	Code	Price
Credenza Base	3232 TBT9	+ \$415

2. Size

Credenza Top Size (D x W)	Code	Price
18" x 54"	TZ1854	+ \$35
18" x 60"	TZ1860	+ \$35
18" x 66"	TZ1866	+ \$35
18" x 72"	TZ1872	+ \$55
24" x 54"	TZ2454	+ \$35
24" x 60"	TZ2460	+ \$35
24" x 66"	TZ2466	+ \$35
24" x 72"	TZ2472	+ \$55
30" x 54"	TZ3054	+ \$35
30" x 60"	TZ3060	+ \$35
30" x 66"	TZ3066	+ \$35
30" x 72"	TZ3072	+ \$55

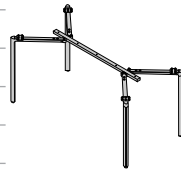

Credenza bases require the specification of a credenza top size. Bases take their size from their corresponding top size.

3. Base Finish

Paint Color	Code	Price
Silver	BF01	\$0
White	BF02	\$0
Black	BF03	\$0

Voyager

2-LEG HEIGHT-ADJUSTABLE TABLE

Make your move.

Reach new heights with the Voyager. Designed and built to be configurable for spaces of any shape and size, get the do-it-all desk that works with a multitude of convenient workspace options.



24" x 48" Voyager
Chair sold separately;
See page 173 for Wit.

Featured Models

24" x 48" :: \$1,004

24" x 48" rectangular top no grommets, 2-leg height-adjustable base, standard up/down controller, glides

30" x 60" :: \$1,175

30" x 60" rectangular top with no grommets, 2-leg height-adjustable base, programmable controller, glides

Features

- Adjustable desk height with a standard up/down controller at edge of table; programmable controller optional
- 12 different durable laminate options to fit your style
- Three durable powder-coated metal finishes in silver, black or white
- Optional grommets for easy and clean setup of electronic devices
- 220 lb weight capacity warranty

SPECIFICATIONS

	2-Leg Voyager
Height Range	28.5"–47.3"
Foot Length	24.5"
Tabletop Thickness	1.125"
Adjustment Speed	1.5" Per Second
Protection Class	IP 20
Power Cord Length	108"
Power Supply	120 VAC ± 10% Hz
Maximum Input Current	6.5 A
Maximum Power Output	216 VA / 24 V
Standby Power Consumption	0.3 W
Maximum Lift Capacity	200 lb
Weight Capacity Warranty	220 lb

Height range includes 1.125" tabletop.



30" x 60" Voyager
 Chair sold separately; see page 80 for Focus 2.0

1. Product

Product Type	Code	Price
Tabletop	3071 TBT6	Priced by Size

2. Size

Tabletop Size (D x W)	Code	Price
24" x 36"	TZ2436	+ \$142
24" x 42"	TZ2442	+ \$166
24" x 48"	TZ2448	+ \$189
24" x 54"	TZ2454	+ \$213
24" x 60"	TZ2460	+ \$236
24" x 66"	TZ2466	+ \$261
24" x 72"	TZ2472	+ \$284
24" x 78"	TZ2478	+ \$308
24" x 84"	TZ2484	+ \$331
30" x 36"	TZ3036	+ \$178
30" x 42"	TZ3042	+ \$208
30" x 48"	TZ3048	+ \$236
30" x 54"	TZ3054	+ \$266
30" x 60"	TZ3060	+ \$295
30" x 66"	TZ3066	+ \$325
30" x 72"	TZ3072	+ \$354
30" x 78"	TZ3078	+ \$384
30" x 84"	TZ3084	+ \$414

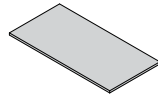

4. Grommets

Grommet Location	Code	Price
None	GP00	+ \$0
Left	GP01	+ \$30
Center	GP02	+ \$30
Right	GP03	+ \$30
Left and Center	GP04	+ \$60
Left and Right	GP05	+ \$60
Right and Center	GP06	+ \$60
Left, Right and Center	GP07	+ \$90

Grommet Color	Code	Price
Black	GC01	+ \$0
White	GC02	+ \$0

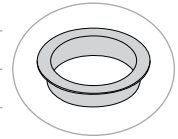

3. Top Finish

Laminate	Code	Price
Ankara Cherry	TL18	+ \$0
Black	TL19	+ \$0
Brazilian Walnut	TL20	+ \$0
Cabinet Maple	TL21	+ \$0
Contour White	TL22	+ \$0
Driftwood	TL23	+ \$0
Folkstone Grey	TL24	+ \$0
Libretti	TL25	+ \$0
Queenston Oak	TL26	+ \$0
Sandalwood	TL27	+ \$0
Walnut Amati	TL28	+ \$0
White	TL29	+ \$0

1. Product

Product Type	Code	Price
2-Leg Table Base	3072 TBT6	\$815

2 .Size

Tabletop Size (D x W)	Code	Price
24" x 36"	TZ2436	+ \$0
24" x 42"	TZ2442	+ \$0
24" x 48"	TZ2448	+ \$0
24" x 54"	TZ2454	+ \$0
24" x 60"	TZ2460	+ \$0
24" x 66"	TZ2466	+ \$0
24" x 72"	TZ2472	+ \$84
24" x 78"	TZ2478	+ \$84
24" x 84"	TZ2484	+ \$84
30" x 36"	TZ3036	+ \$0
30" x 42"	TZ3042	+ \$0
30" x 48"	TZ3048	+ \$0
30" x 54"	TZ3054	+ \$0
30" x 60"	TZ3060	+ \$0
30" x 66"	TZ3066	+ \$0
30" x 72"	TZ3072	+ \$84
30" x 78"	TZ3078	+ \$84
30" x 84"	TZ3084	+ \$84

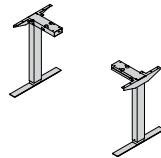

Table bases require the specification of a tabletop size. Bases take their size from their corresponding top size.

3. Base Finish

Paint Color	Code	Price
Silver	BF01	+ \$0
White	BF02	+ \$0
Black	BF03	+ \$0

2-LEG HEIGHT-ADJUSTABLE BASE

4. Power

Controller	Code	Price
Standard Up/Down Controller	HC01	+ \$0
Programmable Controller	HC02	+ \$65

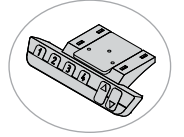

5. Feet

Foot Style	Code	Price
Glides	LS18	+ \$0
Casters	LS19	+ \$109

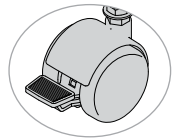
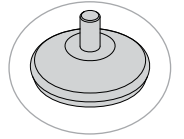

Voyager

3-LEG HEIGHT-ADJUSTABLE TABLE

Make your move.

Reach new heights with the Voyager. Designed and built to be configurable for spaces of any shape and size, get the do-it-all desk that works with a multitude of convenient workspace options.



*3-Leg 120-Degree
Chair sold separately;
see page 121 for Novo.*

Featured Models

90-Degree 3-Leg :: \$1,885

30" x 60" rectangular top with no grommets, 30" x 42" return top with no grommets, 3-leg 90-degree height-adjustable base, standard up/down controller, glides

120-Degree 3-Leg :: \$2,438

24" x 48" 120-degree top with no grommets, 3-leg height adjustable-base, standard up/down controller, glides

Features

- Adjustable desk height with with a standard up/down controller at edge of table; programmable controller optional
- Patented anti-collision sensor that detects potential impact and damage
- Twelve different durable laminate options to fit your style
- Three durable powder-coated metal finishes in silver, black or white
- Optional grommets for easy and clean setup of electronic devices
- 220 lb weight capacity warranty

SPECIFICATIONS

	Voyager 3-Leg
Height Range	28.5"-47.3"
Foot Length	22"
Tabletop Thickness	1.125"
Adjustment Speed	1.5" Per Second
Protection Class	IP 20
Power Cord Length	108"
Power Supply	120 VAC ± 10% Hz
Maximum Input Current	6.5 A
Maximum Power Output	216 VA / 24 V
Standby Power Consumption	0.3 W
Maximum Lift Capacity	250 lb
Weight Capacity Warranty	250 lb

Height range includes 1.125" tabletop.



*3-Leg 90-Degree
Chair sold separately;
see page 181 for Wit Thintex.*

TABLETOP FOR 3-LEG BASE

TOPS AND BASES ARE SPECIFIED AND SOLD SEPARATELY.

1. Tabletop

Product Type	Code	Price
Tabletop 3-Leg Base	3071 TBT8	Priced by Size

2. Size

Tabletop Size (D x W)	Code	Price
120-Degree Top		
24" x 42"	TA2442	\$517
24" x 48"	TA2448	\$666
30" x 42"	TA3042	\$540
30" x 48"	TA3048	\$673
Rectangular Top		
24" x 60"	TZ2460	\$236
24" x 66"	TZ2466	\$261
24" x 72"	TZ2472	\$284
24" x 78"	TZ2478	\$308
24" x 84"	TZ2484	\$331
30" x 60"	TZ3060	\$295
30" x 66"	TZ3066	\$325
30" x 72"	TZ3072	\$354
30" x 78"	TZ3078	\$384
30" x 84"	TZ3084	\$414

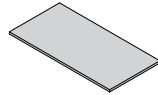
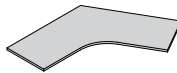

To use the 3-leg 90-degree base, you must select both a rectangular tabletop and a return. Tabletop depth and return depth must match.

3. Top Finish

Laminate	Code	Price
Ankara Cherry	TL18	+ \$0
Black	TL19	+ \$0
Brazilian Walnut	TL20	+ \$0
Cabinet Maple	TL21	+ \$0
Contour White	TL22	+ \$0
Driftwood	TL23	+ \$0
Folkstone Grey	TL24	+ \$0
Libretti	TL25	+ \$0
Queenston Oak	TL26	+ \$0
Sandalwood	TL27	+ \$0
Walnut Amati	TL28	+ \$0
White	TL29	+ \$0

4. Grommets

Grommet Location	Code	Price
None	GP00	+ \$0
Left	GP01	+ \$30
Center	GP02	+ \$30
Right	GP03	+ \$30
Left and Center	GP04	+ \$60
Left and Right	GP05	+ \$60
Right and Center	GP06	+ \$60
Left, Right and Center	GP07	+ \$90
Grommet Color	Code	Price
Black	GC01	+ \$0
White	GC02	+ \$0

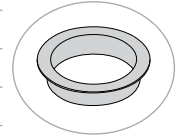

1. Product

Product Type	Code	Price
Return Top	3071 TBT8	Priced by Size

2. Size

Return Top Size (D x W)	Code	Price
24" x 36"	TN2436	\$142
24" x 42"	TN2442	\$166
24" x 48"	TN2448	\$189
30" x 30"	TN3030	\$148
30" x 36"	TN3036	\$178
30" x 42"	TN3042	\$208
30" x 48"	TN3048	\$236

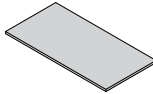

To use the 3-leg 90-degree base, you must select both a rectangular tabletop and a return. Tabletop depth and return depth must match.

3. Top Finish

Laminate	Code	Price
Ankara Cherry	TL18	+ \$0
Black	TL19	+ \$0
Brazilian Walnut	TL20	+ \$0
Cabinet Maple	TL21	+ \$0
Contour White	TL22	+ \$0
Driftwood	TL23	+ \$0
Folkstone Grey	TL24	+ \$0
Libretti	TL25	+ \$0
Queenston Oak	TL26	+ \$0
Sandalwood	TL27	+ \$0
Walnut Amati	TL28	+ \$0
White	TL29	+ \$0

RETURN TOP FOR 90-DEGREE BASE

TOPS AND BASES ARE SPECIFIED AND SOLD SEPARATELY.

4. Grommets

Grommet Location	Code	Price
None	GP00	+ \$0
Left	GP01	+ \$30
Center	GP02	+ \$30
Right	GP03	+ \$30
Left and Center	GP04	+ \$60
Left and Right	GP05	+ \$60
Right and Center	GP06	+ \$60
Left, Right and Center	GP07	+ \$90

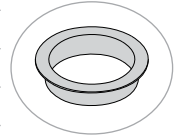

Grommet Color	Code	Price
Black	GC01	+ \$0
White	GC02	+ \$0

1. Product

Product Type	Code	Price	
2-Stage 3-Leg Base	3072	Priced by Style	
Product Style	Code	Price	
120-Degree Base	TBT8	\$1,315	
90-Degree Base	TBT8	\$1,382	

2. Size

Tabletop Size (D x W)	Code	Price	
3-Leg 120-Degree Base			
24" x 42"	TA2442	+ \$0	
24" x 48"	TA2448	+ \$0	
30" x 42"	TA3042	+ \$0	
30" x 48"	TA3048	+ \$0	
3-Leg 90-Degree Base			
24" x 60"	TZ2460	+ \$0	
24" x 66"	TZ2466	+ \$0	
24" x 72"	TZ2472	+ \$67	
24" x 78"	TZ2478	+ \$67	
24" x 84"	TZ2484	+ \$67	
30" x 60"	TZ3060	+ \$0	
30" x 66"	TZ3066	+ \$0	
30" x 72"	TZ3072	+ \$67	
30" x 78"	TZ3078	+ \$67	
30" x 84"	TZ3084	+ \$67	

Table bases require the specification of a tabletop size. Bases take their size from their corresponding top size.

3. Base Finish

Paint Color	Code	Price	
Silver	BF01	+ \$0	
White	BF02	+ \$0	
Black	BF03	+ \$0	

3-LEG BASE

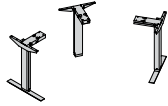
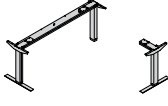
TOPS AND BASES ARE SPECIFIED AND SOLD SEPARATELY.

4. Power

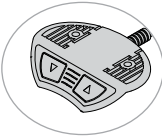
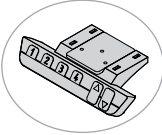
Controller	Code	Price	
Standard Up/Down Controller	HC01	+ \$0	
Programmable Controller	HC02	+ \$68	

5. Feet

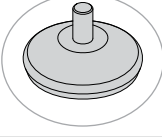
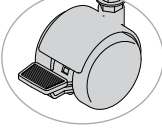
Foot Style	Code	Price	
Glides	LS18	+ \$0	
Casters	LS19	+ \$109	

Benching

FIXED | SINGLE-SIDED | BACK-TO-BACK

Prise

BENCHING TYPICALS

One size really does fit all. Prise is the go-to solution for modular benching, allowing you to build and arrange to fit your workspace. Keep cords, electronics and more all together with standard integrated power trays and slide-out tabletops.



Private Office



Conference



Side-by-Side



Three-Seat



Three-Seat With Screens



Three-Seat With Returns



Six-Seat With Screens

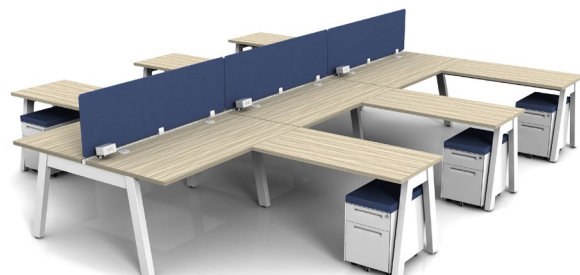

Six-Seat With Returns

1. Side-by-Side Typical

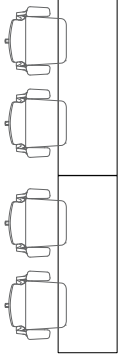
Category	Code	Quantity	Description	List Price	Ext. Price	
Bench Top	3021 SS SP2 TZ2472 TL27 GP05 GC02	1	Set of Two Bench Tops: 24" x 72", Laminate, Left and Right Grommets	\$688	\$688	
Bench Base	3022 SS SP2 TZ2472 PIW	1	2-Seat Base: Single-Sided, 8-Wire Wall Infeed (Pairs With 24" x 72" Bench Top)	\$2,134	\$2,134	
Modesty Screen	3093 MT8 DT501 MPC27 DS1066	2	Modesty Screen: 10" x 66", Laminate	\$239	\$478	
Wire Management	3152 WM05	2	Wire Basket Without Power	\$67	\$134	

TOTAL: \$3,434

2. Private Office Typical

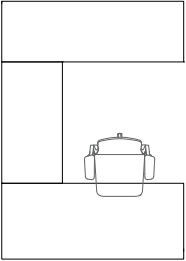
Category	Code	Quantity	Description	List Price	Ext. Price	
Bench Top	3021 SS SP1 TZ3072 TL27 GP00	1	Bench Top: 30" x 72", Laminate, No Grommets	\$354	\$354	
Tabletop (See Page 495 to Order Tabletops)	3000 TZ2448 TL27 GP00 TTMP1 STF00	1	Rectangular Tabletop: 24" x 48" Laminate, Mending Plate Kit, No Stiffner, No Grommets	\$263	\$263	
Tabletop (See Page 495 to Order Tabletops)	3000 TZ2472 TL27 GP00 TTMP1 STF00	1	Rectangular Tabletop: 24" x 72", Laminate, Mending Plate Kit, No Stiffner, No Grommets	\$284	\$284	
Bench Base	3022 SS SP1 TZ3072 NPOW	1	1-Seat Base: Single-Sided, No Power (Pairs With 30" x 72" Bench Top)	\$886	\$886	
Bench Base	3022 SS SP1 TZ2472 NPOW	1	1-Seat Base: Single-Sided, No Power (Pairs With 24" x 72" Tabletop)	\$886	\$886	
Modesty Screen	3093 MT8 DT501 MPC27 DS1066	1	Modesty Screen: 10" x 66", Laminate	\$322	\$322	
Storage	3150 CPT01 PDC02	1	Mobile Pedestal With Upholstered Cushion, Grade 1 Textile	\$393	\$393	

TOTAL: \$3,388

3. Conference Typical

Category	Code	Quantity	Description	List Price	Ext. Price
Tabletop (See 495 to Order Oversized Top)	3000 TZ4896 TL27 GP00 TTMP0 STF00	1	Rectangular Tabletop: 48" x 96", Laminate, No Grommets, No Stiffner	\$825	\$825
Bench Base	3022 BB SP2 TZ3066 NPOW	1	2-Seat Base: Back-to-Back, No Power	\$1,393	\$1,393

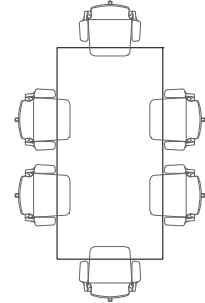

TOTAL: \$2,218

4. Three Seat Typical

Category	Code	Quantity	Description	List Price	Ext. Price
Bench Top	3021 SS SP3 TZ3060 TL27 GP05 GC02	1	Set of Three Bench Tops: 30" x 60", Laminate, Grommets on the Left and Right	\$1,065	\$1,065
Bench Base	3022 SS SP3 TZ3060 PIW	1	3-Seat Base: Single-Sided, 8-Wire Wall Infeed (Pairs With 30" x 60" Bench Top)	\$3,106	\$3,106
Modesty Screen	3093 MT8 DT501 MPC27 DS1054	3	Modesty Screen: 10" x 54", Laminate	\$204	\$612
Storage	3150 CPT01 PDC02	3	Mobile Pedestal With Upholstered Cushion, Grade 1 Textile	\$393	\$1,179
Wire Management	3152 WM05	3	Wire Basket Without Power	\$67	\$201

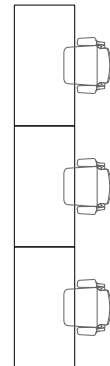

TOTAL: \$6,163

5. Three Seat Typical With Screens

Category	Code	Quantity	Description	List Price	Ext. Price
Bench Top	3021 SS SP3 TZ3060 TL27 GP05 GC02	1	Set of Three Bench Tops: 30" x 60", Laminate, Left and Right Grommets	\$1,065	\$1,065
Base	3022 SS SP3 TZ3060 PIW	1	3-Seat Base: Single Sided, 8-Wire Wall Infeed (Pairs With 30" x 60" Top)	\$3,106	\$3,106
Screen (See the Screens Section Starting Page 446 for Midway Mounts and Other Screen Options)	3090 MT5 DT701 DS3060	3	30" x 60", Fabric, Grade 1 Textile, Midway Mounts	\$706	\$2,118
Storage	3150 CPT01 PDC02	3	Mobile Pedestal With Upholstered Cushion, Grade 1 Textile	\$393	\$1,179
Wire Management	3152 WM05	3	Wire Basket Without Power	\$67	\$201

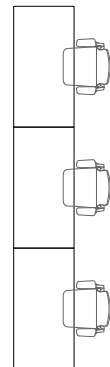

TOTAL: \$7,667

6. Three-Seat Typical With Returns

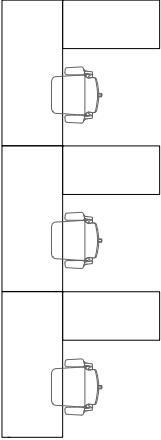
Category	Code	Quantity	Description	List Price	Ext. Price	
Bench Top	3021 SS SP3 TZ3072 TL27 GP05 GC02	1	Set of Three Bench Tops: 30" x 72", Laminate, Left and Right Grommets	\$1,242	\$1,242	
Returntop	3024 SS SP3 RP3 TN2448 TL27 GP00	1	Set of Three Returntops: 24" x 48", Laminate, No Grommets	\$567	\$567	
Bench Base	3022 SS SP3 TZ3072 PIW	1	3-Seat Base: Single-Sided, 8-Wire Wall Infeed (Pairs With 30" x 72" Bench Tops)	\$3,106	\$3,106	
Return Base	3025 SS SP3 RP3 TN2448	1	Set of Three Return Bases: Single-Sided (Pairs With 24" x 48" Returntops)	\$1,296	\$1,296	
Modesty Screen	3093 MT8 DT501 MPC27 DS1066	3	Modesty Screen: 10" x 66", Laminate	\$239	\$717	
Storage	3150 CPT01 PDC02	3	Mobile Pedestal With Upholstered Cushion, Grade 1 Textile	\$393	\$1,179	
Wire Management	3152 WM05	3	Wire Basket Without Power	\$67	\$201	

TOTAL: \$8,308

7. Six-Seat Typical With Screens

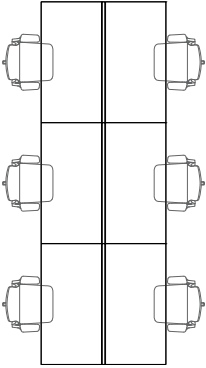
Category	Code	Quantity	Description	List Price	Ext. Price	
Bench Top	3021 BB SP6 TZ3060 TL27 GP05 GC02	1	Set of Six Bench Tops: 30" x 60", Laminate, Left and Right Grommets	\$2,130	\$2,130	
Bench Base	3022 BB SP6 TZ3060 PIW	1	6-Seat Base: Back-to-Back, 8-Wire Wall Infeed (Pairs With 30" x 60" Bench Tops)	\$4,691	\$4,691	
Screen	3023 BB SP6 TZ3060 DT701 DS1860	1	Set of Three Screens: 18" x 60" Fabric, Prise Mounts	\$1,284	\$1,284	
Storage	3150 CPT01 PDC02	6	Mobile Pedestal With Upholstered Cushion, Grade 1 Textile	\$393	\$2,358	

TOTAL: \$10,463

8. Six-Seat Typical With Returns

Category	Code	Quantity	Description	List Price	Ext. Price	
Bench Top	3021 BB SP6 TZ3072 TL27 GP05 GC02	1	Set of Six Bench Tops: 30" x 72", Laminate, Left and Right Grommets	\$2,484	\$2,484	
Returntop	3024 BB SP6 RP6 TN2448 TL27 GP00	1	Set of Six Returntops: 24" x 48", Laminate, No Grommets.	\$1,134	\$1,134	
Bench Base	3022 BB SP6 TZ3072 PIW	1	6-Seat Base: Back-to-Back, 8-Wire Wall Infeed (Pairs With 30" x 72" Bench Tops)	\$4,691	\$4,691	
Return Base	3025 BB SP6 RP6 TN2448	1	Set of Six Return Bases (Pair With 24" x 48" Returntops)	\$2,592	\$2,592	
Screen	3023 BB SP6 TZ3072 DT701 DS1872	1	Set of Three Screens: 18" x 72", Fabric, Prise Mounts	\$1,659	\$1,659	
Storage	3150 CPT01 PDC02	6	Mobile Pedestal With Upholstered Cushion, Grade 1 Textile	\$393	\$2,358	

TOTAL: \$14,918

Prise

BENCHING

One size really does fit all. Prise is the go-to solution for modular benching, allowing you to build and arrange to fit your workspace. Keep cords, electronics and more all together with standard integrated power trays and slide-out tabletops.



6-Seat

Chairs not included; see 121 for Novo.
Storage not included; see page 489 for mobile pedestals.

Featured Models

2-SEAT :: \$3,434

2-seat, single-sided, 34" x 72" benchtops, 10" x 66" laminate modesty screens, and wire basket wire management

6-SEAT :: \$10,463

6-seat, back-to-back, 30" x 60" benchtops with grommets on the left and right, 18" x 60" fabric screens, mobile pedestals with upholstered pads

6-SEAT+RETURNS :: \$14,918

6-seat, back-to-back, 30" x 72" benchtops with grommets on the left and right, 18" x 72" fabric screens, 24" x 48" returns, mobile pedestals with upholstered pads





Features

- Steel-frame-constructed bench with standard white base
- Mount screens easily with centered built-in extrusion on bench
- Manage wires with standard integrated power trays and slide-out function for tabletops
- Choose from 12 standard laminate tabletop finishes
- Pick grommets from two colors and specify in multiple locations
- Fixed glides are standard on all models
- Four power ports come standard per bench station; data add-on optional when specified with power
- Provide added convenience with a variety of additional wire management and power options

SPECIFICATIONS

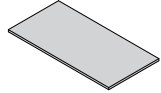
	3021 SS Single-Sided Benching	3021 BB Back-to-Back Benching
Total Depth of Benches	24" 30"	51.44" (24" Top) 63.44" (30" Top)
Space Between Back-to-Back Benches	N/A	3.44"
Gap on Either Side of Center Rail	N/A	1.09"
Benchtop Thickness	1.125"	1.125"
Side-to-Side Gap (Mid Run)	0.125"	0.125"
Height With Benchtop	29.3"	29.3"
Height From Floor to Underside of Base	24.24"	24.24"
Distance Between Legs (Depth) at Base (Inside-Edge-to-Inside-Edge End)	17.52"	40.42"
Distance Between Legs (Depth) at Top	9"	32"
Distance Between Legs at Base (Outside-Edge-to-Outside-Edge)	23.96"	46.85"
Leg Depth	3.17"	3.17"
Leg Width	1.99"	1.99"
Weight Capacity (Per Seat or Return)	200 lb	200 lb

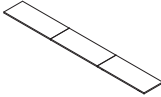
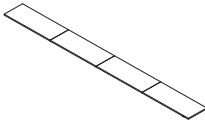
1. Product

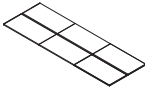
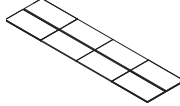
Product Type	Code	Price	
Benchtop	3021	Priced by Size	
Orientation	Code	Price	
Single-Sided	SS	Priced by Size	
Back-to-Back	BB	Priced by Size	
Seated Positions	Code	Price	
Single-Sided			
One Seat	SP1	Priced by Size	
Two Seats	SP2	Priced by Size	
Three Seats	SP3	Priced by Size	
Four Seats	SP4	Priced by Size	
Back-to-Back			
Two Seats	SP2	Priced by Size	
Four Seats	SP4	Priced by Size	
Six Seats	SP6	Priced by Size	
Eight Seats	SP8	Priced by Size	

2. Size

Depth x Width	Code	Base Price
One Seat (SS)		
24" x 48"	TZ2448	\$189
24" x 54"	TZ2454	\$213
24" x 60"	TZ2460	\$236
24" x 66"	TZ2466	\$261
24" x 72"	TZ2472	\$284
30" x 48"	TZ3048	\$236
30" x 54"	TZ3054	\$266
30" x 60"	TZ3060	\$295
30" x 66"	TZ3066	\$325
30" x 72"	TZ3072	\$354
Two Seats (SS or BB)		
24" x 48"	TZ2448	\$378
24" x 54"	TZ2454	\$426
24" x 60"	TZ2460	\$472
24" x 66"	TZ2466	\$522
24" x 72"	TZ2472	\$568
30" x 48"	TZ3048	\$472
30" x 54"	TZ3054	\$532
30" x 60"	TZ3060	\$590
30" x 66"	TZ3066	\$650
30" x 72"	TZ3072	\$708
Three Seats (SS)		
24" x 48"	TZ2448	\$567
24" x 54"	TZ2454	\$639
24" x 60"	TZ2460	\$708
24" x 66"	TZ2466	\$783
24" x 72"	TZ2472	\$852
30" x 48"	TZ3048	\$708
30" x 54"	TZ3054	\$798
30" x 60"	TZ3060	\$885
30" x 66"	TZ3066	\$975
30" x 72"	TZ3072	\$1,062

2. Size (Cont.)

Depth x Width	Code	Base Price
Four Seats (SS or BB)		
24" x 48"	TZ2448	\$756
24" x 54"	TZ2454	\$852
24" x 60"	TZ2460	\$944
24" x 66"	TZ2466	\$1,044
24" x 72"	TZ2472	\$1,136
30" x 48"	TZ3048	\$944
30" x 54"	TZ3054	\$1,064
30" x 60"	TZ3060	\$1,180
30" x 66"	TZ3066	\$1,300
30" x 72"	TZ3072	\$1,416
Six Seats (BB)		
24" x 48"	TZ2448	\$1,134
24" x 54"	TZ2454	\$1,278
24" x 60"	TZ2460	\$1,416
24" x 66"	TZ2466	\$1,566
24" x 72"	TZ2472	\$1,704
30" x 48"	TZ3048	\$1,416
30" x 54"	TZ3054	\$1,596
30" x 60"	TZ3060	\$1,770
30" x 66"	TZ3066	\$1,950
30" x 72"	TZ3072	\$2,124
Eight Seats (BB)		
24" x 48"	TZ2448	\$1,512
24" x 54"	TZ2454	\$1,704
24" x 60"	TZ2460	\$1,888
24" x 66"	TZ2466	\$2,088
24" x 72"	TZ2472	\$2,272
30" x 48"	TZ3048	\$1,888
30" x 54"	TZ3054	\$2,128
30" x 60"	TZ3060	\$2,360
30" x 66"	TZ3066	\$2,600
30" x 72"	TZ3072	\$2,832

3. Top Finish

Laminate	Code	Price
Ankara Cherry	TL18	+ \$0
Black	TL19	+ \$0
Brazilian Walnut	TL20	+ \$0
Cabinet Maple	TL21	+ \$0
Contour White	TL22	+ \$0
Driftwood	TL23	+ \$0
Folkstone Grey	TL24	+ \$0
Libretti	TL25	+ \$0
Queenston Oak	TL26	+ \$0
Sandalwood	TL27	+ \$0
Walnut Amati	TL28	+ \$0
White	TL29	+ \$0

4. Grommets



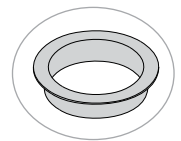





Grommet Location	Code	Price
None	GP00	+ \$0
One Seat (SS)		
Left	GP01	+ \$30
Right	GP03	+ \$30
Left and Right	GP05	+ \$60
Two Seats (SS or BB)		
Left	GP01	+ \$60
Right	GP03	+ \$60
Left and Right	GP05	+ \$120
Three Seats (SS)		
Left	GP01	+ \$90
Right	GP03	+ \$90
Left and Right	GP05	+ \$180
Four Seats (SS or BB)		
Left	GP01	+ \$120
Right	GP03	+ \$120
Left and Right	GP05	+ \$240
Six Seats (BB)		
Left	GP01	+ \$180
Right	GP03	+ \$180
Left and Right	GP05	+ \$360
Eight Seats (BB)		
Left	GP01	+ \$240
Right	GP03	+ \$240
Left and Right	GP05	+ \$480
Grommet Color	Code	Price
Black	GC01	+ \$0
White	GC02	+ \$0



BENCH BASE

TOPS AND BASES ARE SPECIFIED AND SOLD SEPARATELY.

1. Product

Product Type	Code	Price	
Bench Bases	3022	Priced by Seated Positions	
Orientation	Code	Price	
Single-Sided	SS	Priced by Seated Positions	
Back-to-Back	BB	Priced by Seated Positions	
Seated Postions	Code	Price	
Single-Sided			
1-Seat	SP1	\$795	
2-Seat	SP2	\$1,415	
3-Seat	SP3	\$2,034	
4- Seat	SP4	\$2,654	
Back-to-Back			
2-Seat	SP2	\$1,250	
4- Seat	SP4	\$2,144	
6-Seat	SP6	\$3,038	
8-Seat	SP8	\$3,934	

2. Size

Top Size	Code	Price	
No Top	TZ0	+ \$0	
24" x 48"	TZ2448	+ \$0	
24" x 54"	TZ2454	+ \$0	
24" x 60"	TZ2460	+ \$0	
24" x 66"	TZ2466	+ \$0	
24" x 72"	TZ2472	+ \$0	
30" x 48"	TZ3048	+ \$0	
30" x 54"	TZ3054	+ \$0	
30" x 60"	TZ3060	+ \$0	
30" x 66"	TZ3066	+ \$0	
30" x 72"	TZ3072	+ \$0	

Bench bases require the specification of a benchtop size. Bases take their size from their corresponding top size.

3. Power

Power Type	Code	Price	
No Power Pack	NPOW	+ \$0	
Single-Sided, 8-Wire Wall Infeed			
One Seat	PIW	\$1,250	
Two Seats	PIW	\$2,144	
Three Seats	PIW	\$3,038	
Four Seats	PIW	\$3,934	
Single-Sided, 8-Wire Ceiling Infeed			
One Seat	PIC	+ \$390	
Two Seats	PIC	+ \$744	
Three Seats	PIC	+ \$1,098	
Four Seats	PIC	+ \$1,450	
Back-to-Back, 8-Wire Wall Infeed			
Two Seats	PIW	+ \$559	
Four Seats	PIW	+ \$1,106	
Six Seats	PIW	+ \$1,653	
Eight Seats	PIW	+ \$2,200	
Back-to-Back, 8-Wire Ceiling Infeed			
Two Seats	PIC	+ \$585	
Four Seats	PIC	+ \$1,131	
Six Seats	PIC	+ \$1,678	
Eight Seats	PIC	+ \$2,225	

Infeeds come standard with one dual outlet power module per seat.

RETURN TOP

TOPS AND BASES ARE SPECIFIED AND SOLD SEPARATELY.

1. Returntop

Product Type	Code	Price
--------------	------	-------

Returntop	3024	Priced by Size
-----------	------	----------------

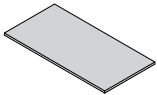

Orientation	Code	Price
-------------	------	-------

Single-Sided	SS	Priced by Size
Back-to-Back	BB	Priced by Size

Seated Postions	Code	Price
-----------------	------	-------

Single-Sided		
One Seat	SP1	Priced by Size
Two Seats	SP2	Priced by Size
Three Seats	SP3	Priced by Size
Four Seats	SP4	Priced by Size

Back-to-Back		
---------------------	--	--

Two Seats	SP2	Priced by Size
Four Seats	SP4	Priced by Size
Six Seats	SP6	Priced by Size
Eight Seats	SP8	Priced by Size

Return Quantity	Code	Price
-----------------	------	-------

One	RP1	Priced by Size
Two	RP2	Priced by Size
Three	RP3	Priced by Size
Four	RP4	Priced by Size
Five	RP5	Priced by Size
Six	RP6	Priced by Size
Seven	RP7	Priced by Size
Eight	RP8	Priced by Size

2. Size

Returntop Size (D x W)	Code	Price
------------------------	------	-------

One		
24" x 36"	TN2436	\$142
24" x 42"	TN2442	\$166
24" x 48"	TN2448	\$189
30" x 30"	TN3030	\$148
30" x 36"	TN3036	\$178
30" x 42"	TN3042	\$208

2. Size (Cont.)

Returntop Size (D x W)	Code	Price
------------------------	------	-------

Two		
------------	--	--

24" x 36"	TN2436	\$284
24" x 42"	TN2442	\$332
24" x 48"	TN2448	\$378
30" x 30"	TN3030	\$296
30" x 36"	TN3036	\$356
30" x 42"	TN3042	\$416

Three		
--------------	--	--

24" x 36"	TN2436	\$426
24" x 42"	TN2442	\$498
24" x 48"	TN2448	\$567
30" x 30"	TN3030	\$444
30" x 36"	TN3036	\$534
30" x 42"	TN3042	\$624

Four		
-------------	--	--

24" x 36"	TN2436	\$568
24" x 42"	TN2442	\$664
24" x 48"	TN2448	\$756
30" x 30"	TN3030	\$592
30" x 36"	TN3036	\$712
30" x 42"	TN3042	\$832

Five		
-------------	--	--

24" x 36"	TN2436	\$710
24" x 42"	TN2442	\$830
24" x 48"	TN2448	\$945
30" x 30"	TN3030	\$740
30" x 36"	TN3036	\$890
30" x 42"	TN3042	\$1,040

Six		
------------	--	--

24" x 36"	TN2436	\$852
24" x 42"	TN2442	\$996
24" x 48"	TN2448	\$1,134
30" x 30"	TN3030	\$888
30" x 36"	TN3036	\$1,068
30" x 42"	TN3042	\$1,248

2. Size (Cont.)

Returntop Size (D x W)	Code	Price	
Seven			
24" x 36"	TN2436	\$994	
24" x 42"	TN2442	\$1,162	
24" x 48"	TN2448	\$1,323	
30" x 30"	TN3030	\$1,036	
30" x 36"	TN3036	\$1,246	
30" x 42"	TN3042	\$1,456	
Eight			
24" x 36"	TN2436	\$1,136	
24" x 42"	TN2442	\$1,328	
24" x 48"	TN2448	\$1,512	
30" x 30"	TN3030	\$1,184	
30" x 36"	TN3036	\$1,424	
30" x 42"	TN3042	\$1,664	

3. Top Finish

Laminate	Code	Price	
Ankara Cherry	TL18	+ \$0	
Black	TL19	+ \$0	
Brazilian Walnut	TL20	+ \$0	
Cabinet Maple	TL21	+ \$0	
Contour White	TL22	+ \$0	
Driftwood	TL23	+ \$0	
Folkstone Grey	TL24	+ \$0	
Libretti	TL25	+ \$0	
Queenston Oak	TL26	+ \$0	
Sandalwood	TL27	+ \$0	
Walnut Amati	TL28	+ \$0	
White	TL29	+ \$0	

4. Grommets

Grommet Location	Code	Price	
None	GP00	+ \$0	
One Seat			
Left	GP01	+ \$30	
Right	GP03	+ \$30	
Left and Right	GP05	+ \$60	
Two Seats			
Left	GP01	+ \$60	
Right	GP03	+ \$60	
Left and Right	GP05	+ \$120	
Three Seats			
Left	GP01	+ \$90	
Right	GP03	+ \$90	
Left and Right	GP05	+ \$180	
Four Seats			
Left	GP01	+ \$120	
Right	GP03	+ \$120	
Left and Right	GP05	+ \$240	
Five Seats			
Left	GP01	+ \$150	
Right	GP03	+ \$150	
Left and Right	GP05	+ \$300	
Six Seats			
Left	GP01	+ \$180	
Right	GP03	+ \$180	
Left and Right	GP05	+ \$360	
Seven Seats			
Left	GP01	+ \$210	
Right	GP03	+ \$210	
Left and Right	GP05	+ \$420	
Eight Seats			
Left	GP01	+ \$240	
Right	GP03	+ \$240	
Left and Right	GP05	+ \$480	
Grommet Color	Code	Price	
Black	GC01	+ \$0	
White	GC02	+ \$0	

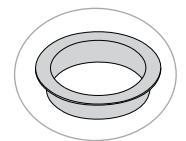

RETURN BASE

TOPS AND BASES ARE SPECIFIED AND SOLD SEPARATELY.

1. Product

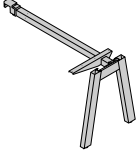
Product Type	Code	Price	
Return Base	3025	Priced by Quantity	

Orientation	Code	Price	
Single-Sided	SS	Priced by Quantity	
Back-to-Back	BB	Priced by Quantity	

Seated Postions	Code	Price	
Single-Sided			
One Seat	SP1	Priced by Quantity	
Two Seats	SP2	Priced by Quantity	
Three Seats	SP3	Priced by Quantity	
Four Seats	SP4	Priced by Quantity	

Back-to-Back			
Two Seats	SP2	Priced by Quantity	
Four Seats	SP4	Priced by Quantity	
Six Seats	SP6	Priced by Quantity	
Eight Seats	SP8	Priced By Quantity	

Return Quantity	Code	Price	
One	RP1	\$432	
Two	RP2	\$864	
Three	RP3	\$1,296	
Four	RP4	\$1,728	
Five	RP5	\$2,160	
Six	RP6	\$2,592	
Seven	RP7	\$3,024	
Eight	RP8	\$3,456	

Number of returns cannot exceed the number of seats.

2. Size

Returntop Size (D x W)	Code	Price	
No Return	TN0	+ \$0	
24" x 36"	TN2436	+ \$0	
24" x 42"	TN2442	+ \$0	
24" x 48"	TN2448	+ \$0	
30" x 30"	TN3030	+ \$0	
30" x 36"	TN3036	+ \$0	
30" x 42"	TN3042	+ \$0	

Return bases require the specification of a returntop size. Bases take their size from their corresponding top size.

1. Product

Product Type	Code	Price
Screen	3023	Priced By Screen Size

2. Matching Benching

Orientation	Code	Price
Single-Sided	SS	Priced By Screen Size
Back-to-Back	BB	Priced By Screen Size

Seated Positions	Code	Price
Single-Sided		
One Seat	SP1	Priced By Screen Size
Two Seats	SP2	Priced By Screen Size
Three Seats	SP3	Priced By Screen Size
Four Seats	SP4	Priced By Screen Size

Back-to-Back		
Two Seats	SP2	Priced by Screen Size
Four Seats	SP4	Priced by Screen Size
Six Seats	SP6	Priced by Screen Size
Eight Seats	SP8	Priced by Screen Size

Bench Top Size	Code	Price
None	TZ0	Priced by Screen Size
24" x 48"	TZ2448	Priced by Screen Size
24" x 54"	TZ2454	Priced by Screen Size
24" x 60"	TZ2460	Priced by Screen Size
24" x 66"	TZ2466	Priced by Screen Size
24" x 72"	TZ2472	Priced by Screen Size
30" x 48"	TZ3048	Priced by Screen Size
30" x 54"	TZ3054	Priced by Screen Size
30" x 60"	TZ3060	Priced by Screen Size
30" x 66"	TZ3066	Priced by Screen Size
30" x 72"	TZ3072	Priced by Screen Size

Single-sided orientation comes standard with edge mounts. Back-to-back orientation includes the cost of Prize-specific screen mounts.

Screens require the specification of a bench top size. Screen length may not exceed benchtop length.

3. Material

Screen Material	Code	Price
Frosted Acrylic	DT101	Priced by Screen Size
Fabric	DT701	Priced by Screen Size
Markerboard	DT301	Priced by Screen Size

4. Size

Screen Size (H x L)	Code	Price		
One Seat, Single-Sided		Acrylic	Fabric	Markerboard
12" x 48"	DS1248	\$280	\$339	\$245
12" x 54"	DS1254	\$304	\$364	\$265
12" x 60"	DS1260	\$371	\$424	\$328
12" x 66"	DS1266	\$395	\$476	\$348
12" x 72"	DS1272	\$419	\$507	\$367
18" x 48"	DS1848	\$375	\$457	\$323
18" x 54"	DS1854	\$411	\$464	\$353
18" x 60"	DS1860	\$491	\$560	\$426
18" x 66"	DS1866	\$493	\$652	\$456
18" x 72"	DS1872	\$524	\$708	\$485
24" x 48"	DS2448	\$427	\$508	\$402
24" x 54"	DS2454	\$481	\$551	\$441
24" x 60"	DS2460	\$556	\$630	\$524
24" x 66"	DS2466	\$598	\$735	\$563
24" x 72"	DS2472	\$640	\$796	\$602
Two Seat, Single-Sided		Acrylic	Fabric	Markerboard
12" x 48"	DS1248	\$560	\$678	\$490
12" x 54"	DS1254	\$608	\$728	\$530
12" x 60"	DS1260	\$742	\$848	\$656
12" x 66"	DS1266	\$790	\$952	\$696
12" x 72"	DS1272	\$838	\$1,014	\$734
18" x 48"	DS1848	\$750	\$914	\$646
18" x 54"	DS1854	\$822	\$928	\$706
18" x 60"	DS1860	\$982	\$1,120	\$852
18" x 66"	DS1866	\$986	\$1,304	\$912
18" x 72"	DS1872	\$1,048	\$1,416	\$970
24" x 48"	DS2448	\$854	\$1,016	\$804
24" x 54"	DS2454	\$962	\$1,102	\$882
24" x 60"	DS2460	\$1,112	\$1,260	\$1,048
24" x 66"	DS2466	\$1,196	\$1,470	\$1,126
24" x 72"	DS2472	\$1,280	\$1,592	\$1,204

4. Size (Cont.)

Screen Size (H x L)	Code	Price		
Three Seats, Single-Sided		Acrylic	Fabric	Markerboard
12" x 48"	DS1248	\$840	\$1,017	\$735
12" x 54"	DS1254	\$912	\$1,092	\$795
12" x 60"	DS1260	\$1,113	\$1,272	\$984
12" x 66"	DS1266	\$1,185	\$1,428	\$1,044
12" x 72"	DS1272	\$1,257	\$1,521	\$1,101
18" x 48"	DS1848	\$1,125	\$1,371	\$969
18" x 54"	DS1854	\$1,233	\$1,392	\$1,059
18" x 60"	DS1860	\$1,473	\$1,680	\$1,278
18" x 66"	DS1866	\$1,479	\$1,956	\$1,368
18" x 72"	DS1872	\$1,572	\$2,124	\$1,455
24" x 48"	DS2448	\$1,281	\$1,524	\$1,206
24" x 54"	DS2454	\$1,443	\$1,653	\$1,323
24" x 60"	DS2460	\$1,668	\$1,890	\$1,572
24" x 66"	DS2466	\$1,794	\$2,205	\$1,689
24" x 72"	DS2472	\$1,920	\$2,388	\$1,806
Four Seats, Single-Sided		Acrylic	Fabric	Markerboard
12" x 48"	DS1248	\$1,120	\$1,356	\$980
12" x 54"	DS1254	\$1,216	\$1,456	\$1,060
12" x 60"	DS1260	\$1,484	\$1,696	\$1,312
12" x 66"	DS1266	\$1,580	\$1,904	\$1,392
12" x 72"	DS1272	\$1,676	\$2,028	\$1,468
18" x 48"	DS1848	\$1,500	\$1,828	\$1,292
18" x 54"	DS1854	\$1,644	\$1,856	\$1,412
18" x 60"	DS1860	\$1,964	\$2,240	\$1,704
18" x 66"	DS1866	\$1,972	\$2,608	\$1,824
18" x 72"	DS1872	\$2,096	\$2,832	\$1,940
24" x 48"	DS2448	\$1,708	\$2,032	\$1,608
24" x 54"	DS2454	\$1,924	\$2,204	\$1,764
24" x 60"	DS2460	\$2,224	\$2,520	\$2,096
24" x 66"	DS2466	\$2,392	\$2,940	\$2,252
24" x 72"	DS2472	\$2,560	\$3,184	\$2,408

4. Size (Cont.)

Screen Size (H x L)	Code	Price		
Two Seats, Back-to-Back		Acrylic	Fabric	Markerboard
12" x 48"	DS1248	\$192	\$251	\$157
12" x 54"	DS1254	\$216	\$276	\$177
12" x 60"	DS1260	\$239	\$292	\$354
12" x 66"	DS1266	\$263	\$344	\$216
12" x 72"	DS1272	\$287	\$375	\$235
18" x 48"	DS1848	\$287	\$369	\$235
18" x 54"	DS1854	\$323	\$376	\$265
18" x 60"	DS1860	\$359	\$428	\$294
18" x 66"	DS1866	\$361	\$520	\$324
18" x 72"	DS1872	\$392	\$576	\$353
24" x 48"	DS2448	\$339	\$420	\$314
24" x 54"	DS2454	\$393	\$463	\$353
24" x 60"	DS2460	\$424	\$498	\$392
24" x 66"	DS2466	\$466	\$603	\$431
24" x 72"	DS2472	\$508	\$664	\$470
Four Seats, Back-to-Back		Acrylic	Fabric	Markerboard
12" x 48"	DS1248	\$384	\$502	\$314
12" x 54"	DS1254	\$432	\$552	\$354
12" x 60"	DS1260	\$478	\$584	\$392
12" x 66"	DS1266	\$526	\$688	\$432
12" x 72"	DS1272	\$574	\$750	\$470
18" x 48"	DS1848	\$574	\$738	\$470
18" x 54"	DS1854	\$646	\$752	\$530
18" x 60"	DS1860	\$718	\$856	\$588
18" x 66"	DS1866	\$722	\$1,040	\$648
18" x 72"	DS1872	\$784	\$1,152	\$706
24" x 48"	DS2448	\$678	\$840	\$628
24" x 54"	DS2454	\$786	\$926	\$706
24" x 60"	DS2460	\$848	\$996	\$784
24" x 66"	DS2466	\$932	\$1,206	\$862
24" x 72"	DS2472	\$1,016	\$1,328	\$940

4. Size (Cont.)

Screen Size (H x L)	Code	Price		
Six Seats, Back-to-Back		Acrylic	Fabric	Markerboard
12" x 48"	DS1248	\$576	\$753	\$471
12" x 54"	DS1254	\$648	\$828	\$531
12" x 60"	DS1260	\$717	\$876	\$588
12" x 66"	DS1266	\$789	\$1,032	\$648
12" x 72"	DS1272	\$861	\$1,125	\$705
18" x 48"	DS1848	\$861	\$1,107	\$705
18" x 54"	DS1854	\$969	\$1,128	\$795
18" x 60"	DS1860	\$1,077	\$1,284	\$882
18" x 66"	DS1866	\$1,083	\$1,560	\$972
18" x 72"	DS1872	\$1,176	\$1,728	\$1,059
24" x 48"	DS2448	\$1,017	\$1,260	\$942
24" x 54"	DS2454	\$1,179	\$1,389	\$1,059
24" x 60"	DS2460	\$1,272	\$1,494	\$1,176
24" x 66"	DS2466	\$1,398	\$1,809	\$1,293
24" x 72"	DS2472	\$1,524	\$1,992	\$1,410
Eight Seats, Back-to-Back		Acrylic	Fabric	Markerboard
12" x 48"	DS1248	\$768	\$1,004	\$628
12" x 54"	DS1254	\$864	\$1,104	\$708
12" x 60"	DS1260	\$956	\$1,168	\$784
12" x 66"	DS1266	\$1,052	\$1,376	\$864
12" x 72"	DS1272	\$1,148	\$1,500	\$940
18" x 48"	DS1848	\$1,148	\$1,476	\$940
18" x 54"	DS1854	\$1,292	\$1,504	\$1,060
18" x 60"	DS1860	\$1,436	\$1,712	\$1,176
18" x 66"	DS1866	\$1,444	\$2,080	\$1,296
18" x 72"	DS1872	\$1,568	\$2,304	\$1,412
24" x 48"	DS2448	\$1,356	\$1,680	\$1,256
24" x 54"	DS2454	\$1,572	\$1,852	\$1,412
24" x 60"	DS2460	\$1,696	\$1,992	\$1,568
24" x 66"	DS2466	\$1,864	\$2,412	\$1,724
24" x 72"	DS2472	\$2,032	\$2,656	\$1,880

1. Power

Product Type	Code	Price
Data Pack	3029 PDP	+ \$49

Screens

WORKSURFACE | MODESTY
FREESTANDING | MOBILE | CAFÉ
SEATING | TRANSACTION | TRIFOLD

Doodle

MARKERBOARD WORKSURFACE SCREEN

Write away (right away).

From big idea-making to simple note-taking, stay on task with a tool that helps you work. Our Doodle markerboards provide essential privacy as a screen while promoting impactful productivity as a convenient place to write.



12" x 23" Middle Mount
Table not included. See page 410 for Tensor.
Chairs not included. See page 95 for Ioniq.

Featured Models

12" x 23" MIDDLE :: \$168

12" x 23" markerboard screen,
middle mount

24" x 60" EDGE :: \$540

24" x 60" markerboard screen,
edge mount

30" x 60" :: \$570

30" x 60" markerboard screen,
midway mount

Features

- Non-ghosting, durable writing surface can withstand endless scribbles and wipes
- Compatible with dry erase and wet erase markers
- Slim, straightforward design mixes well with any workspace
- Height options: 12, 18 and 24 inches; 30 inches available for midway and height-adjustable mounts
- Width options: 17 to 72 inches (in six-inch increments)
- Compatible with most mounts, including edge, middle, top, midway, freestanding, panel and height-adjustable

1. Product

Product Type	Code	Price
Worksurface Screen	3090	Priced by Size

2. Material

Material	Code	Price
Markerboard	DT301	Priced by Size







3. Size

Screen Size (H x W)	Code	Price
17" Wide Side Screen		
12" x 17"	DS1217	\$56
18" x 17"	DS1817	\$84
24" x 17"	DS2417	\$112
23" Wide Side Screen		
12" x 23"	DS1223	\$76
18" x 23"	DS1823	\$114
24" x 23"	DS2423	\$151
29" Wide Side Screen		
12" x 29"	DS1229	\$95
18" x 29"	DS1829	\$143
24" x 29"	DS2429	\$190
24" Wide Screen		
24" x 24"	DS2424	\$151
24" x 30"	DS2430	\$190

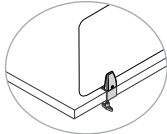
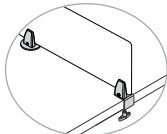
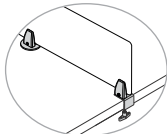
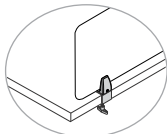
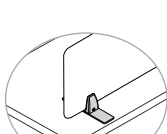
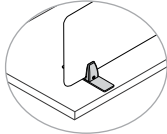
3. Size (Cont.)

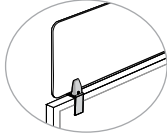
Screen Size (H x W)	Code	Price
30" Wide Screen		
24" x 30"	DS2430	\$190
30" x 30"	DS3030	\$238
36" Wide Screen		
12" x 36"	DS1236	\$118
18" x 36"	DS1836	\$177
24" x 36"	DS2436	\$235
30" x 36"	DS3036	\$285
42" Wide Screen		
12" x 42"	DS1242	\$137
18" x 42"	DS1842	\$206
24" x 42"	DS2442	\$274
30" x 42"	DS3042	\$333
48" Wide Screen		
12" x 48"	DS1248	\$157
18" x 48"	DS1848	\$235
24" x 48"	DS2448	\$314
30" x 48"	DS3048	\$380
54" Wide Screen		
12" x 54"	DS1254	\$177
18" x 54"	DS1854	\$265
24" x 54"	DS2454	\$353
30" x 54"	DS3054	\$427
60" Wide Screens		
12" x 60"	DS1260	\$196
18" x 60"	DS1860	\$294
24" x 60"	DS2460	\$392
30" x 60"	DS3060	\$475
66" Wide Screen		
12" x 66"	DS1266	\$216
18" x 66"	DS1866	\$324
24" x 66"	DS2466	\$431
30" x 66"	DS3066	\$522
72" Wide Screen		
12" x 72"	DS1272	\$235
18" x 72"	DS1872	\$353
24" x 72"	DS2472	\$470
30" x 72"	DS3072	\$570

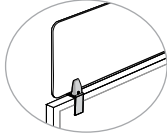
4. Mount

Mount Style	Code	Price	
Protective/Privacy			
Edge Mount Compatibility: 17"-54" Screen Width 12"-24" Screen Height	MT1	+ \$88	
Edge Mount Compatibility: 60"-72" Screen Width 12"-24" Screen Height	MT1	+ \$132	
Middle Mount Compatibility: 17"-29" Screen Width 12"-24" Screen Height	MT2	+ \$88	
Top Mount Compatibility: 17"-54" Screen Width 12"-24" Screen Height	MT3	+ \$56	
Top Mount Compatibility: 60"-72" Screen Width 12"-24" Screen Height	MT3	+ \$84	
Freestanding Mount Compatibility: 17"-54" Screen Width 12"-24" Screen Height	MT4	+ \$88	
Freestanding Mount Compatibility: 60"-72" Screen Width 12"-24" Screen Height	MT4	+ \$132	
Small Panel Mount Compatibility: 1.5"-2.3" Panel Depth 17"-54" Screen Width 12"-24" Screen Height	MT9	+ \$88	
Small Panel Mount Compatibility: 1.5"-2.3" Panel Depth 60"-72" Screen Width 12"-24" Screen Height	MT9	+ \$132	
Large Panel Mount Compatibility: 2.3"-3.7" Panel Depth 17"-54" Screen Width 12"-24" Screen Height	MT10	+ \$88	
Large Panel Mount Compatibility: 2.3"-3.7" Panel Depth 60"-72" Screen Width 12"-24" Screen Height	MT10	+ \$132	

MARKERBOARD WORKSURFACE SCREEN

4. Mount (Cont.)

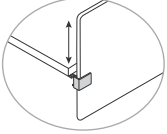
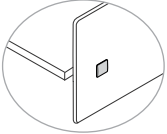
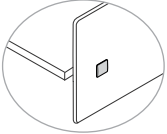
Mount Style	Code	Price	
Protective/Privacy + Modesty			
Height-Adjustable Compatibility: 24"-60" Screen Width 24"-30" Screen Height	MT6	+ \$80	
Midway Compatibility: 17"-54" Screen Width 24"-30" Screen Height	MT5	+ \$38	
Midway Compatibility: 60"-72" Screen Width 24"-30" Screen Height	MT5	+ \$76	

Modesty

WORKSURFACE SCREEN

Versatile peace of mind.

We all need our own space. Increase office and employee privacy with our selection of modesty screens that attach right onto our desks and benches. In addition, shield cords, wires and more from sight for a clean and organized workspace.



*Frosted Acrylic Modesty Screen
Table not included. See page 381 for Ocala.
Chair not included. See page 173 for Wit.*

Featured Models

LAMINATE :: \$221

10" x 60" laminate screen

ACRYLIC :: \$298

10" x 60" frosted acrylic screen

Features

- Extra privacy for users
- Attaches onto edge of bench or table
- Can be installed fixed or hinged
- Screens can be built from frosted acrylic or laminate
- Available 12 standard laminate finishes
- Screens are 10" high and available in widths ranging from 36" to 72"
- Acrylic panels are 0.24" thick; laminate screens are 1.125" thick

1. Product

Product Type	Code	Price
Modesty Screen	3093	Priced by Size

2. Material

Material Type	Code	Price
Frosted Acrylic	DT101	Priced by Size
Laminate	DT501	Priced by Size
Laminate	Code	Price
Ankara Cherry	MPC18	+ \$0
Black	MPC19	+ \$0
Brazilian Walnut	MPC20	+ \$0
Cabinet Maple	MPC21	+ \$0
Contour White	MPC22	+ \$0
Driftwood	MPC23	+ \$0
Folkstone Grey	MPC24	+ \$0
Libretti	MPC25	+ \$0
Queenston Oak	MPC26	+ \$0
Sandalwood	MPC27	+ \$0
Walnut Amati	MPC28	+ \$0
White	MPC29	+ \$0

Select laminate finish only if ordering a laminate (DT501) screen.

3. Size

Screen Size (H x W)	Code	Price	
		Acrylic	Laminate
10" x 36"	DS1036	+ \$203	+ \$152
10" x 42"	DS1042	+ \$227	+ \$180
10" x 48"	DS1048	+ \$251	+ \$187
10" x 54"	DS1054	+ \$275	+ \$204
10" x 60"	DS1060	+ \$298	+ \$221
10" x 66"	DS1066	+ \$322	+ \$239
10" x 72"	DS1072	+ \$360	+ \$256

4. Mount

Mount Style	Code	Price
Modesty Screen Mount Compatibility: 36"-72" Screen Width 10" Screen Height	MT8	+ \$0

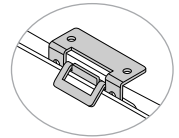

Modesty screens include the cost of the mount.

Motif

FABRIC WORKSURFACE SCREEN

Social distancing with style.

Divide and conquer the challenges of the "new normal" with Motif. Our collection of modern, well-designed privacy and modesty screens help you fashion spaces that are safe, secluded and color coordinated with the entire office.



30" x 60" Screen With Midway Mount
Table not included; see page 410 for Tensor.

Featured Models

12" x 23" EDGE :: \$233

12" x 23" fabric screen, edge mount, grade 1 textile

30" x 48" HA :: \$522

30" x 48" fabric screen, height-adjustable mount, grade 1 textile

30" x 60" MIDWAY :: \$630

30" x 60" fabric screen, midway mount, grade 1 textile

Features

- Get customized privacy with durable fabrics designed to heal from pins, thumbtacks and more
- Find privacy + protection with fabrics that are bleach-cleanable, helping protect against COVID-19
- Eco-friendly, single-piece construction features a HexaCore honeycomb center, providing rigidity with less weight
- Height options include 12, 18, and 24 inches; 30 inches available for midway and height-adjustable mounts
- Width options range from 17 to 72 inches (in six-inch increments)
- Compatible with most mounts, including edge, middle, top, midway, freestanding, panel and height-adjustable

1. Product

Product Type	Code	Price
Screen	3090	Priced by Size

2. Material

Material Type	Code	Price			
Fabric/Vinyl	DT701	Priced by Grade and Size			
Material Grade	Code	12" (H) Price	18" (H) Price	24" (H) Price	30" (H) Price
17" Wide Side Screens		12" x 17"	18" x 17"	24" x 17"	—
Base Price		\$130	\$183	\$221	—
Fabric/Vinyl Grade 1	FG1/VG1	+\$0	+\$0	+\$0	—
Fabric/Vinyl Grade 2	FG2/VG2	+\$7	+\$7	+\$13	—
Fabric/Vinyl Grade 3	FG3/VG3	+\$18	+\$18	+\$36	—
Fabric/Vinyl Grade 4	FG4/VG4	+\$31	+\$31	+\$63	—
Fabric/Vinyl Grade 5	FG5/VG5	+\$54	+\$54	+\$107	—
23" Wide Side Screens		12" x 23"	18" x 23"	24" x 23"	—
Base Price		\$145	\$203	\$245	—
Fabric/Vinyl Grade 1	FG1/VG1	+\$0	+\$0	+\$0	—
Fabric/Vinyl Grade 2	FG2/VG2	+\$9	+\$9	+\$17	—
Fabric/Vinyl Grade 3	FG3/VG3	+\$23	+\$23	+\$46	—
Fabric/Vinyl Grade 4	FG4/VG4	+\$40	+\$40	+\$81	—
Fabric/Vinyl Grade 5	FG5/VG5	+\$69	+\$69	+\$138	—

GSA SIN #: 33721

2. Material (Cont.)

Material Grade	Code	12" (H) Price	18" (H) Price	24" (H) Price	30" (H) Price
29" Wide Side Screens		12" x 29"	18" x 29"	24" x 29"	—
Base Price		\$161	\$225	\$272	
Fabric/Vinyl Grade 1	FG1/VG1	+ \$0	+ \$0	+ \$0	—
Fabric/Vinyl Grade 2	FG2/VG2	+ \$11	+ \$11	+ \$21	—
Fabric/Vinyl Grade 3	FG3/VG3	+ \$28	+ \$28	+ \$57	—
Fabric/Vinyl Grade 4	FG4/VG4	+ \$50	+ \$50	+ \$99	—
Fabric/Vinyl Grade 5	FG5/VG5	+ \$85	+ \$85	+ \$170	—
24" Wide Screens		—	—	24" x 24"	30" x 24"
Base Price		—	—	\$245	\$311
Fabric/Vinyl Grade 1	FG1/VG1	—	—	+ \$0	+ \$0
Fabric/Vinyl Grade 2	FG2/VG2	—	—	+ \$18	+ \$18
Fabric/Vinyl Grade 3	FG3/VG3	—	—	+ \$48	+ \$48
Fabric/Vinyl Grade 4	FG4/VG4	—	—	+ \$84	+ \$84
Fabric/Vinyl Grade 5	FG5/VG5	—	—	+ \$144	+ \$144
30" Wide Screens		—	—	24" x 30"	30" x 30"
Base Price		—	—	\$272	\$345
Fabric/Vinyl Grade 1	FG1/VG1	—	—	+ \$0	+ \$0
Fabric/Vinyl Grade 2	FG2/VG2	—	—	+ \$22	+ \$22
Fabric/Vinyl Grade 3	FG3/VG3	—	—	+ \$58	+ \$58
Fabric/Vinyl Grade 4	FG4/VG4	—	—	+ \$102	+ \$102
Fabric/Vinyl Grade 5	FG5/VG5	—	—	+ \$176	+ \$176
36" Wide Screens		12" x 36"	18" x 36"	24" x 36"	30" x 36"
Base Price		\$189	\$265	\$302	\$383
Fabric/Vinyl Grade 1	FG1/VG1	+ \$0	+ \$0	+ \$0	+ \$0
Fabric/Vinyl Grade 2	FG2/VG2	+ \$13	+ \$13	+ \$26	+ \$26
Fabric/Vinyl Grade 3	FG3/VG3	+ \$35	+ \$35	+ \$69	+ \$69
Fabric/Vinyl Grade 4	FG4/VG4	+ \$60	+ \$60	+ \$121	+ \$121
Fabric/Vinyl Grade 5	FG5/VG5	+ \$104	+ \$104	+ \$208	+ \$208
42" Wide Screens		12" x 42"	18" x 42"	24" x 42"	30" x 42"
Base Price		\$218	\$305	\$335	\$425
Fabric/Vinyl Grade 1	FG1/VG1	+ \$0	+ \$0	+ \$0	+ \$0
Fabric/Vinyl Grade 2	FG2/VG2	+ \$15	+ \$15	+ \$30	+ \$30
Fabric/Vinyl Grade 3	FG3/VG3	+ \$40	+ \$40	+ \$80	+ \$80
Fabric/Vinyl Grade 4	FG4/VG4	+ \$70	+ \$70	+ \$140	+ \$140
Fabric/Vinyl Grade 5	FG5/VG5	+ \$120	+ \$120	+ \$240	+ \$240

2. Material (Cont.)

Material Grade	Code	12" (H) Price	18" (H) Price	24" (H) Price	30" (H) Price
48" Wide Screens		12" x 48"	18" x 48"	24" x 48"	30" x 48"
Base Price		\$246	\$344	\$372	\$472
Fabric/Vinyl Grade 1	FG1/VG1	+ \$0	+ \$0	+ \$0	+ \$0
Fabric/Vinyl Grade 2	FG2/VG2	+ \$17	+ \$17	+ \$34	+ \$34
Fabric/Vinyl Grade 3	FG3/VG3	+ \$45	+ \$45	+ \$90	+ \$90
Fabric/Vinyl Grade 4	FG4/VG4	+ \$79	+ \$79	+ \$158	+ \$158
Fabric/Vinyl Grade 5	FG5/VG5	+ \$136	+ \$136	+ \$272	+ \$272
54" Wide Screens		12" x 54"	18" x 54"	24" x 54"	30" x 54"
Base Price		\$261	\$366	\$413	\$499
Fabric/Vinyl Grade 1	FG1/VG1	+ \$0	+ \$0	+ \$0	+ \$0
Fabric/Vinyl Grade 2	FG2/VG2	+ \$19	+ \$19	+ \$38	+ \$38
Fabric/Vinyl Grade 3	FG3/VG3	+ \$50	+ \$50	+ \$101	+ \$101
Fabric/Vinyl Grade 4	FG4/VG4	+ \$88	+ \$88	+ \$177	+ \$177
Fabric/Vinyl Grade 5	FG5/VG5	+ \$152	+ \$152	+ \$304	+ \$304
60" Wide Screens		12" x 60"	18" x 60"	24" x 60"	30" x 60"
Base Price		\$276	\$387	\$458	\$554
Fabric/Vinyl Grade 1	FG1/VG1	+ \$0	+ \$0	+ \$0	+ \$0
Fabric/Vinyl Grade 2	FG2/VG2	+ \$21	+ \$21	+ \$42	+ \$42
Fabric/Vinyl Grade 3	FG3/VG3	+ \$56	+ \$56	+ \$112	+ \$112
Fabric/Vinyl Grade 4	FG4/VG4	+ \$98	+ \$98	+ \$196	+ \$196
Fabric/Vinyl Grade 5	FG5/VG5	+ \$168	+ \$168	+ \$336	+ \$336
66" Wide Screens		12" x 66"	18" x 66"	24" x 66"	30" x 66"
Base Price		\$294	\$412	\$508	\$569
Fabric/Vinyl Grade 1	FG1/VG1	+ \$0	+ \$0	+ \$0	+ \$0
Fabric/Vinyl Grade 2	FG2/VG2	+ \$23	+ \$23	+ \$46	+ \$46
Fabric/Vinyl Grade 3	FG3/VG3	+ \$61	+ \$61	+ \$122	+ \$122
Fabric/Vinyl Grade 4	FG4/VG4	+ \$107	+ \$107	+ \$214	+ \$214
Fabric/Vinyl Grade 5	FG5/VG5	+ \$184	+ \$184	+ \$368	+ \$368
72" Wide Screens		12" x 72"	18" x 72"	24" x 72"	30" x 72"
Base Price		\$311	\$436	\$564	\$584
Fabric/Vinyl Grade 1	FG1/VG1	+ \$0	+ \$0	+ \$0	+ \$0
Fabric/Vinyl Grade 2	FG2/VG2	+ \$25	+ \$25	+ \$50	+ \$50
Fabric/Vinyl Grade 3	FG3/VG3	+ \$66	+ \$66	+ \$133	+ \$133
Fabric/Vinyl Grade 4	FG4/VG4	+ \$116	+ \$116	+ \$233	+ \$233
Fabric/Vinyl Grade 5	FG5/VG5	+ \$200	+ \$200	+ \$400	+ \$400







3. Size

Screen Size (H x W)	Code	Price
17" Wide Side Screens		
12" x 17"	DS1217	+ \$0
18" x 17"	DS1817	+ \$0
24" x 17"	DS2417	+ \$0
23" Wide Side Screens		
12" x 23"	DS1223	+ \$0
18" x 23"	DS1823	+ \$0
24" x 23"	DS2423	+ \$0
29" Wide Side Screens		
12" x 29"	DS1229	+ \$0
18" x 29"	DS1829	+ \$0
24" x 29"	DS2429	+ \$0
24" Wide Screens		
24" x 24"	DS2424	+ \$0
30" x 24"	DS3024	+ \$0
30" Wide Screens		
24" x 30"	DS2430	+ \$0
30" x 30"	DS3030	+ \$0
36" Wide Screens		
12" x 36"	DS1236	+ \$0
18" x 36"	DS1836	+ \$0
24" x 36"	DS2436	+ \$0
30" x 36"	DS3036	+ \$0
42" Wide Screens		
12" x 42"	DS1242	+ \$0
18" x 42"	DS1842	+ \$0
24" x 42"	DS2442	+ \$0
30" x 42"	DS3042	+ \$0

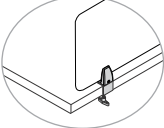
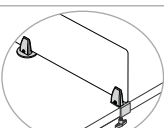
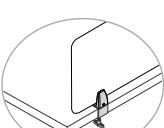
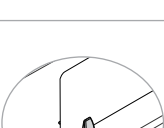
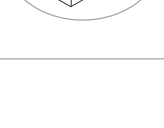
3. Size (Cont.)

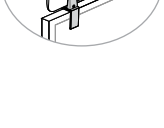
Screen Size (H x W)	Code	Price
48" Wide Screens		
12" x 48"	DS1248	+ \$0
18" x 48"	DS1848	+ \$0
24" x 48"	DS2448	+ \$0
30" x 48"	DS3048	+ \$0
54" Wide Screens		
12" x 54"	DS1254	+ \$0
18" x 54"	DS1854	+ \$0
24" x 54"	DS2454	+ \$0
30" x 54"	DS3054	+ \$0
60" Wide Screens		
12" x 60"	DS1260	+ \$0
18" x 60"	DS1860	+ \$0
24" x 60"	DS2460	+ \$0
30" x 60"	DS3060	+ \$0
66" Wide Screens		
12" x 66"	DS1266	+ \$0
18" x 66"	DS1866	+ \$0
24" x 66"	DS2466	+ \$0
30" x 66"	DS3066	+ \$0
72" Wide Screens		
12" x 72"	DS1272	+ \$0
18" x 72"	DS1872	+ \$0
24" x 72"	DS2472	+ \$0
30" x 72"	DS3072	+ \$0

4. Mount

Mount Style	Code	Price	
Protective/Privacy			
Edge Mount Compatibility: 17"-54" Screen Width 12"-24" Screen Height	MT1	+ \$88	
Edge Mount Compatibility: 60"-72" Screen Width 12"-24" Screen Height	MT1	+ \$132	
Middle Mount Compatibility: 17"-29" Screen Width 12"-24" Screen Height	MT2	+ \$88	
Top Mount Compatibility: 17"-54" Screen Width 12"-24" Screen Height	MT3	+ \$56	
Top Mount Compatibility: 60"-72" Screen Width 12"-24" Screen Height	MT3	+ \$84	
Freestanding Mount Compatibility: 17"-54" Screen Width 12"-24" Screen Height	MT4	+ \$88	
Freestanding Mount Compatibility: 60"-72" Screen Width 12"-24" Screen Height	MT4	+ \$132	
Small Panel Mount Compatibility: 1.5"-2.3" Panel Depth 17"-54" Screen Width 12"-24" Screen Height	MT9	+ \$88	
Small Panel Mount Compatibility: 1.5"-2.3" Panel Depth 60"-72" Screen Width 12"-24" Screen Height	MT9	+ \$132	
Large Panel Mount Compatibility: 2.3"-3.7" Panel Depth 17"-54" Screen Width 12"-24" Screen Height	MT10	+ \$88	
Large Panel Mount Compatibility: 2.3"-3.7" Panel Depth 60"-72" Screen Width 12"-24" Screen Height	MT10	+ \$132	

FABRIC WORKSURFACE SCREEN

4. Mount (Cont.)

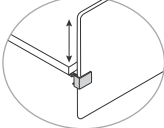
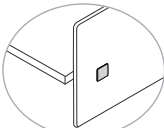
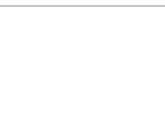
Mount Style	Code	Price	
Protective/Privacy + Modesty			
Height-Adjustable Mount Compatibility: 24"-60" Screen Width 24"-30" Screen Height	MT6	+ \$80	
Midway Mount Compatibility: 17"-54" Screen Width 24"-30" Screen Height	MT5	+ \$38	
Midway Mount Compatibility: 60"-72" Screen Width 24"-30" Screen Height	MT5	+ \$76	

12" x 23" Screen With Edge Mount



Motif

MOBILE + FREESTANDING FABRIC SCREENS

Distance with style.

Now more than ever, our welcoming spaces should be safe—free from contagions, concern and anything that gets in the way of productivity. This collection of mobile and freestanding screens provides the protection and peace of mind you need to work with confidence.



Featured Models

FREESTANDING :: \$917

Freestanding screen with glides, 60" x 36", grade 1 fabric, triangular-shaped feet

MOBILE :: \$1,097

Mobile screen with casters, 60" x 36", grade 1 fabric, T-shaped feet

LARGE MOBILE :: \$1,283

Mobile screen with casters, 48" x 72", grade 1 fabric, T-shaped feet

Features

- Mobile and freestanding screens are an easy-to-deploy solution for environments always in motion
- Quick installation creates safer, color-coordinated spaces in minutes
- Durable fabrics designed to heal from pins, thumbtacks and more
- Find privacy + protection with fabrics that are bleach-cleanable, helping protect against COVID-19
- Eco-friendly, single-piece construction features a Hexacore honeycomb center, providing rigidity with less weight
- Compact foot design allows for easy nesting and almost endless storing
- Black, silver or white frame finish
- Foot styles include freestanding with glides or mobile with casters

MOBILE + FREESTANDING SCREEN

1. Product

Product Type	Code	Price
Mobile + Freestanding Screens	3092	Priced by Fabric Grade and Size

2. Material



Material Type	Code	Price		
Fabric/Vinyl	DT701	Priced by Fabric Grade and Size		
Fabric Grade	Code	Price		
30" Wide Screens		53" x 30"	60" x 30"	72" x 30"
Base Price		\$739	\$842	\$956
Fabric/Vinyl Grade 1	FG1/VG1	+ \$0	+ \$0	+ \$0
Fabric/Vinyl Grade 2	FG2/VG2	+ \$48	+ \$52	+ \$63
Fabric/Vinyl Grade 3	FG3/VG3	+ \$128	+ \$140	+ \$168
Fabric/Vinyl Grade 4	FG4/VG4	+ \$224	+ \$245	+ \$294
Fabric/Vinyl Grade 5	FG5/VG5	+ \$384	+ \$420	+ \$504
36" Wide Screens		53" x 36"	60" x 36"	72" x 36"
Base Price		\$824	\$917	\$1,005
Fabric/Vinyl Grade 1	FG1/VG1	+ \$0	+ \$0	+ \$0
Fabric/Vinyl Grade 2	FG2/VG2	+ \$48	+ \$52	+ \$63
Fabric/Vinyl Grade 3	FG3/VG3	+ \$128	+ \$140	+ \$168
Fabric/Vinyl Grade 4	FG4/VG4	+ \$224	+ \$245	+ \$294
Fabric/Vinyl Grade 5	FG5/VG5	+ \$384	+ \$420	+ \$504
42" Wide Screens		53" x 42"	60" x 42"	72" x 42"
Base Price		\$909	\$992	\$1,044
Fabric/Vinyl Grade 1	FG1/VG1	+ \$0	+ \$0	+ \$0
Fabric/Vinyl Grade 2	FG2/VG2	+ \$48	+ \$52	+ \$63
Fabric/Vinyl Grade 3	FG3/VG3	+ \$128	+ \$140	+ \$168
Fabric/Vinyl Grade 4	FG4/VG4	+ \$224	+ \$245	+ \$294
Fabric/Vinyl Grade 5	FG5/VG5	+ \$384	+ \$420	+ \$504
48" Wide Screens		53" x 48"	60" x 48"	72" x 48"
Base Price		\$992	\$1,067	\$1,103
Fabric/Vinyl Grade 1	FG1/VG1	+ \$0	+ \$0	+ \$0
Fabric/Vinyl Grade 2	FG2/VG2	+ \$48	+ \$52	+ \$63
Fabric/Vinyl Grade 3	FG3/VG3	+ \$128	+ \$140	+ \$168
Fabric/Vinyl Grade 4	FG4/VG4	+ \$224	+ \$245	+ \$294
Fabric/Vinyl Grade 5	FG5/VG5	+ \$384	+ \$420	+ \$504

Please reference the Textile Reference Guide for information on approved textiles for Motif products.

3. Size

Size (H" x W")	Code	Price
53" x 30"	DS5330	+ \$0
53" x 36"	DS5336	+ \$0
53" x 42"	DS5342	+ \$0
53" x 48"	DS5348	+ \$0
60" x 30"	DS6030	+ \$0
60" x 36"	DS6036	+ \$0
60" x 42"	DS6042	+ \$0
60" x 48"	DS6048	+ \$0
72" x 30"	DS7230	+ \$0
72" x 36"	DS7236	+ \$0
72" x 42"	DS7242	+ \$0
72" x 48"	DS7248	+ \$0

4. Base

Base Design	Code	Price	
T-Shaped Foot	SF4	+ \$0	
Triangular-Shaped Foot	SF5	+ \$0	

Base Finish	Code	Price	
Silver	BF01	+ \$0	
White	BF02	+ \$0	
Black	BF03	+ \$0	

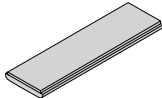
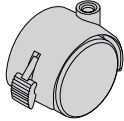
Mobility Options	Code	Price	
Glides	LS18	+ \$0	
Carpet Casters	LS19	+ \$180	

SPECIFICATIONS

Model:	3092 Motif Mobile/Freestanding Screen
Screen Thickness	1"
Foot Height	0.63" (SF4+LS18), 3.25" (SF5+LS18) 2.75" (SF4+LS19), 5.5" (SF5+LS19)
Foot Length	16.38"
Foot Width	1.5"
Floor to Bottom of Screen	2.63" (LS18) 4.75" (SF4+LS19) 4.88" (SF5+LS19)

Glides (LS18). Casters (LS19). T-shaped foot (SF4). Triangular-shaped foot (SF5).

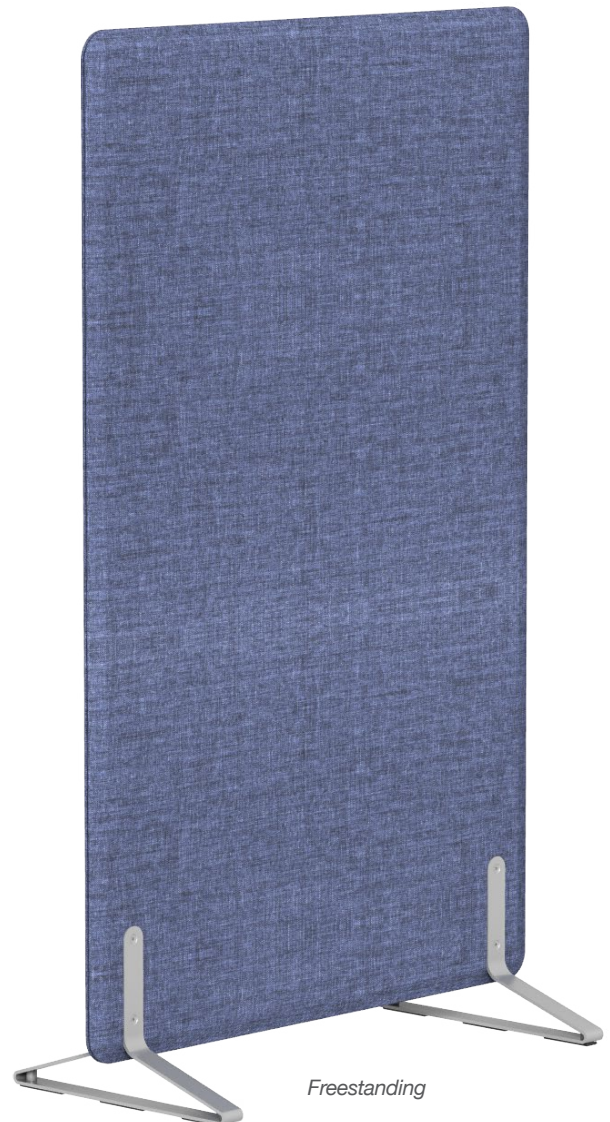

Sector

ACRYLIC WORKSURFACE SCREENS

Partition and protect.

Now more than ever, our workspaces should be safe—free from distractions, contagions and anything that gets in the way of productivity. This collection of clear and frosted acrylic screens stands ready to provide the privacy, protection and peace of mind you need in a landscape where the way we interact changes every day.



*30" x 48" Height-adjustable Frosted Acrylic Screen
Table not included; see page 389 for Switchback 2-Leg.*

Featured Models

12" x 23" EDGE :: \$184

12" x 23" frosted acrylic screen,
edge mount

30" x 48" HA :: \$521

30" x 48" frosted acrylic screen,
height-adjustable mount

30" x 60" MIDWAY :: \$628

30" x 60" clear acrylic screen,
midway mount

Features

- Frosted acrylic provides essential privacy while clear acrylic allows for safe social interactions
- High-performing, resilient acrylic surfaces can withstand some of the most powerful cleaners and disinfectants, including a full range of EPA-approved COVID-19 products
- Lightweight material offers greater resistance to impact compared to glass alternatives
- Height options include 12, 18, and 24 inches; 30 inches available for midway and height-adjustable table mounts
- Width options range from 17 to 72 inches (in six-inch increments)
- Compatible with most mounts, including edge, middle, top, midway, freestanding, panel and height-adjustable

1. Product

Product Type	Code	Price
Screen	3090	Priced by Size

2. Material

Material Type	Code	Price
Clear Acrylic	DT101C	Priced by Size
Frosted Acrylic	DT101	Priced by Size



3. Size

Screen Size (H x W)	Code	Price
17" Wide Side Screens		
12" x 17"	DS1217	+ \$71
18" x 17"	DS1817	+ \$97
24" x 17"	DS2417	+ \$129
23" Wide Side Screens		
12" x 23"	DS1223	+ \$96
18" x 23"	DS1823	+ \$146
24" x 23"	DS2423	+ \$175
29" Wide Side Screens		
12" x 29"	DS1229	+ \$122
18" x 29"	DS1829	+ \$182
24" x 29"	DS2429	+ \$221

3. Size (Cont.)

Screen Size (H x W)	Code	Price
24" Wide Screens		
24" x 24"	DS2424	+ \$175
30" x 24"	DS3024	+ \$221
30" Wide Screens		
24" x 30"	DS2430	+ \$221
30" x 30"	DS3030	+ \$276
36" Wide Screens		
12" x 36"	DS1236	+ \$150
18" x 36"	DS1836	+ \$225
24" x 36"	DS2436	+ \$273
30" x 36"	DS3036	+ \$331
42" Wide Screens		
12" x 42"	DS1242	+ \$175
18" x 42"	DS1842	+ \$263
24" x 42"	DS2442	+ \$319
30" x 42"	DS3042	+ \$386
48" Wide Screens		
12" x 48"	DS1248	+ \$200
18" x 48"	DS1848	+ \$299
24" x 48"	DS2448	+ \$353
30" x 48"	DS3048	+ \$441
54" Wide Screens		
12" x 54"	DS1254	+ \$225
18" x 54"	DS1854	+ \$336
24" x 54"	DS2454	+ \$409
30" x 54"	DS3054	+ \$497
60" Wide Screens		
12" x 60"	DS1260	+ \$249
18" x 60"	DS1860	+ \$374
24" x 60"	DS2460	+ \$441
30" x 60"	DS3060	+ \$552
66" Wide Screens		
12" x 66"	DS1266	+ \$274
18" x 66"	DS1866	+ \$376
24" x 66"	DS2466	+ \$485
30" x 66"	DS3066	+ \$606
72" Wide Screens		
12" x 72"	DS1272	+ \$299
18" x 72"	DS1872	+ \$408
24" x 72"	DS2472	+ \$529
30" x 72"	DS3072	+ \$661

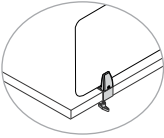
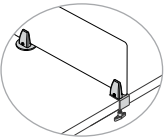
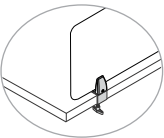
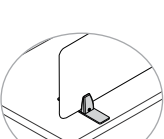
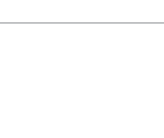
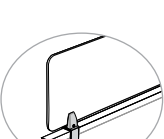
4. Mount

Mount Style	Code	Price	
Protective/Privacy			
Edge Mount Compatibility: 17"-54" Screen Width 12"-24" Screen Height	MT1	+ \$88	
Edge Mount Compatibility: 60"-72" Screen Width 12"-24" Screen Height	MT1	+ \$132	
Middle Mount Compatibility: 17"-29" Screen Width 12"-24" Screen Height	MT2	+ \$88	
Top Mount Compatibility: 17"-54" Screen Width 12"-24" Screen Height	MT3	+ \$56	
Top Mount Compatibility: 60"-72" Screen Width 12"-24" Screen Height	MT3	+ \$84	
Freestanding Mount Compatibility: 17"-54" Screen Width 12"-24" Screen Height	MT4	+ \$88	
Freestanding Mount Compatibility: 60"-72" Screen Width 12"-24" Screen Height	MT4	+ \$132	
Small Panel Mount Compatibility: 1.5"-2.3" Panel Depth 17"-54" Screen Width 12"-24" Screen Height	MT9	+ \$88	
Small Panel Mount Compatibility: 1.5"-2.3" Panel Depth 60"-72" Screen Width 12"-24" Screen Height	MT9	+ \$132	
Large Panel Mount Compatibility: 2.3"-3.7" Panel Depth 17"-54" Screen Width 12"-24" Screen Height	MT10	+ \$88	
Large Panel Mount Compatibility: 2.3"-3.7" Panel Depth 60"-72" Screen Width 12"-24" Screen Height	MT10	+ \$132	

WORKSURFACE SCREEN

4. Mount (Cont.)

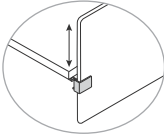
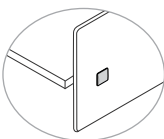
Mount Style	Code	Price	
Protective/Privacy + Modesty			
Height-Adjustable Mount Compatibility: 24"-60" Screen Width 24"-30" Screen Height	MT6	+ \$80	
Midway Mount Compatibility: 17"-54" Screen Width 24"-30" Screen Height	MT5	+ \$38	
Midway Mount Compatibility: 60"-72" Screen Width 24"-30" Screen Height	MT5	+ \$76	

Sector

SCRYLIC CAFÉ SCREENS

Partition and protect.

Partition and protect. Now more than ever, our shared spaces should be safe—free from contagions, concerns and anything that gets in the way of interacting. This collection of acrylic tabletop screens provides the protection and peace of mind you need to socialize with confidence.

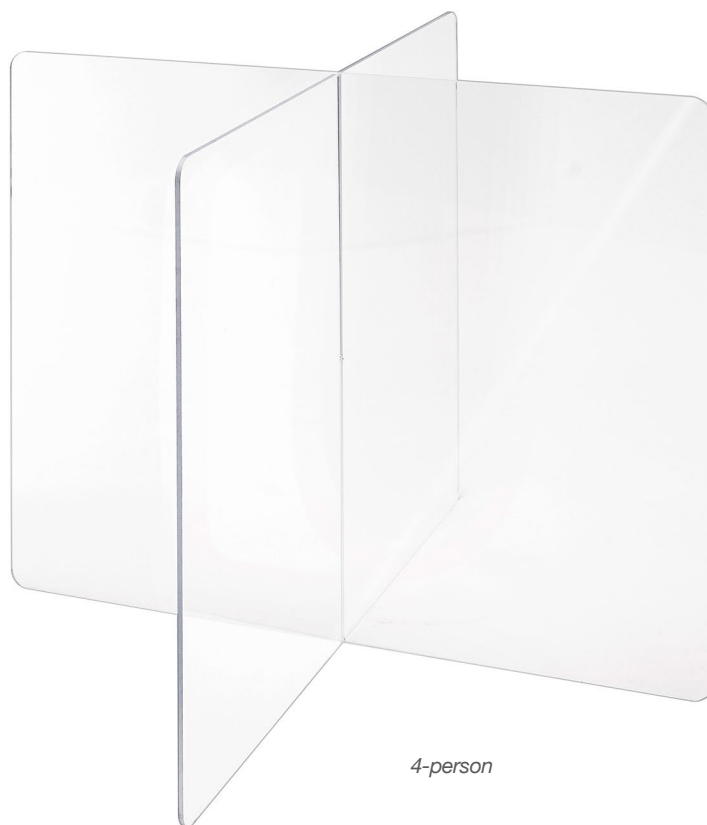

Featured Models

2-PERSON :: \$337

2-person screen for 30 x 30" round table

4-PERSON :: \$477

4-person screen for 48" square table

Features

- Clear acrylic allows for safe social interactions
- High-performing, resilient acrylic surfaces can withstand some of the most powerful cleaners and disinfectants, including a full range of EPA-approved COVID-19 products
- Lightweight material offers greater resistance to impact compared to glass alternatives
- 2-Person café table is available with three different foot styles

1. Product

Product Type	Code	Price
Tabletop Screen	3096	Priced by Size

Screen Type	Code	Price
Café Round	CRSC	Priced by Size
Café Square	CSSC	Priced by Size

2. Material

Material Type	Code	Price
Clear Acrylic	DT101C	Priced by Size

3. Size

Screen Height	Code	Price
Screen Height, 24"	SCH24	Priced by Table Size
Screen Height, 30"	SCH30	Priced by Table Size

Table Size	Code	Price
2-Person Café Screen		
24" Round, 24" Height	TR2424	\$239
24" Round, 30" Height	TR2430	\$287
30" Round, 24" Height	TR3024	\$281
30" Round, 30" Height	TR3030	\$337
24" Square, 24" Height	TS2424	\$239
24" Square, 30" Height	TS2430	\$287
30" Square, 24" Height	TS3024	\$281
30" Square, 30" Height	TS3030	\$337

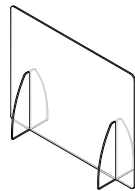

ACRYLIC CAFÉ SCREEN

3. Size (Cont.)

Table Size	Code	Price
4-Person Café Screen		
36" Round, 24" Height	TR3624	\$398
36" Round, 30" Height	TR3630	\$472
42" Round, 24" Height	TR4224	\$438
42" Round, 30" Height	TR4230	\$512
48" Round, 24" Height	TR4824	\$477
48" Round, 30" Height	TR4830	\$525
36" Square, 24" Height	TS3624	\$677
36" Square, 30" Height	TS3630	\$900
42" Square, 24" Height	TS4224	\$745
42" Square, 30" Height	TS4230	\$950
48" Square, 24" Height	TS4824	\$819
48" Square, 30" Height	TS4830	\$1,000

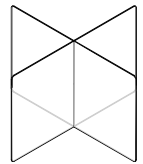

4. Feet (2-Person Only)

Foot Style	Code	Price
Round-Shaped	SF1	+ \$0
T-Shaped	SF2	+ \$0
Square-Shaped	SF3	+ \$0

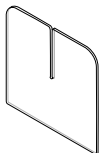
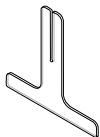
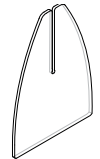

Sector

ACRYLIC SEATING SCREENS

Partition and protect.

Now more than ever, our welcoming spaces should be safe—free from contagions, concern and anything that gets in the way of interacting. This collection of seating screens provides the privacy, protection and peace of mind you need to wait with confidence.



Freelance

Featured Models

AVIERA :: \$460

47" x 24" seating screen compatible with Aviera Guest, Aviera Patient, Aviera Freespan and Aviera Pre-Configured models

FOCUS SIDE :: \$460

47" x 24" seating screen compatible with Focus Side chairs. Not compatible with stools or casters

FREELANCE :: \$460

47" x 24" seating screen compatible with Freelance and Freelance Bariatric chair models. Not compatible with stools or casters

Features

- Compatible with Aviera, Freelance and Focus Side
- Seating screens provide fixed, consistent distancing between each chair for safer spaces
- Patent-pending interlocking mount easily transforms current seating configurations while creating more efficient floor plans
- High-performing, resilient acrylic surfaces can withstand some of the most powerful cleaners and disinfectants, including a full range of EPA approved COVID-19 products
- Frosted acrylic provides privacy while clear acrylic allows for safe interactions
- Quick to ship and easy to integrate
- Silver and black bracket finishes



1. Product

Model	Code	Price	
Screens for Aviera	3097 VRX	\$460	
Screens for Focus Side	3097 56X	\$460	
Screens for Freelance	3097 52X	\$460	

2. Material

Material Type	Code	Price	
Clear Acrylic	DT101C	+ \$0	
Frosted Acrylic	DT101	+ \$0	

3. Size

Screen Size	Code	Price
47" x 24"	DS4724	+\$0

4. Finish

Bracket Finish	Code	Price
Black	BKF03	+\$0
Silver	BKF01	+\$0

5. Replacements

Parts	Code	Price
Screen	Frame and Screen	+\$280
Interlocking Bracket Kit For Focus Side	Complete Bracket	+\$180
Interlocking Bracket Kit For Freelance	Complete Bracket	+\$180
Interlocking Bracket Kit For Aviera	Complete Bracket	+\$180

SPECIFICATIONS

Model:	3097 VRX Seating Screen for Aviera	3097 56X Seating Screen for Focus Side	3097 52X Seating Screen for Freelance
Screen Size	46.5" x 23.5"	46.5" x 23.5"	46.5" x 23.5"
Chair Gap (A) Armless	—	9.5"	10"
Chair Gap (A) With Arms	5.3"	5.7"	6"
From Chair to Screen (B) Armless	—	4.5"	4.75"
From Chair to Screen (B) With Arms	2.4"	2.6"	2.75"
Height to Base of Interlocking Assembly (C)	12.4"	11.3"	11.3"
Height From Floor to Top of Screen (D)	60"	60"	60"
Two Guest Chairs With Screen (E)	54.3"	54.7"	57"
Three Guest Chairs With Screens (F)	84.1"	84.9"	88.5"
Four Guest Chairs With Screens (G)	113.9"	115.1"	120"
Screen Thickness	¼"	¼"	¼"

See the diagram below for assistance with measurements.

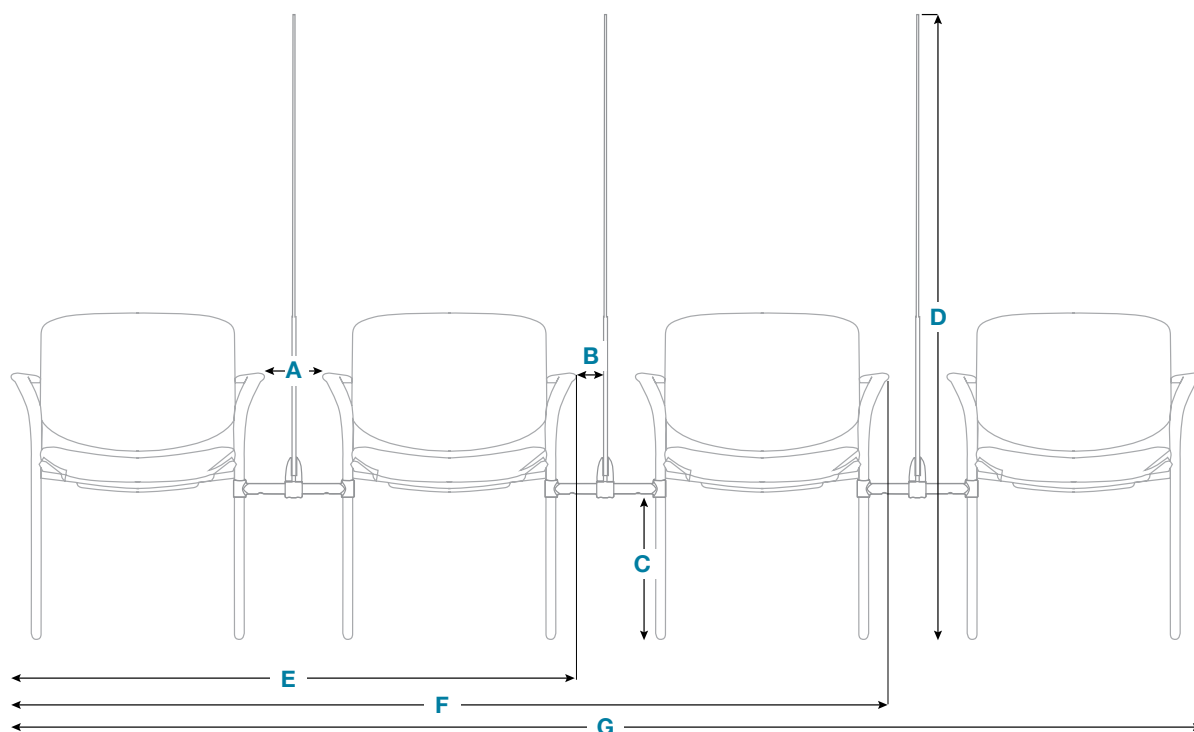

Sector

ACRYLIC TRANSACTION SCREEN

Partition and protect.

Partition and protect. Now more than ever, our shared spaces should be safe—free from contagions, concerns and anything that gets in the way of interacting. This collection of acrylic tabletop screens provides the protection and peace of mind you need to interact with confidence.

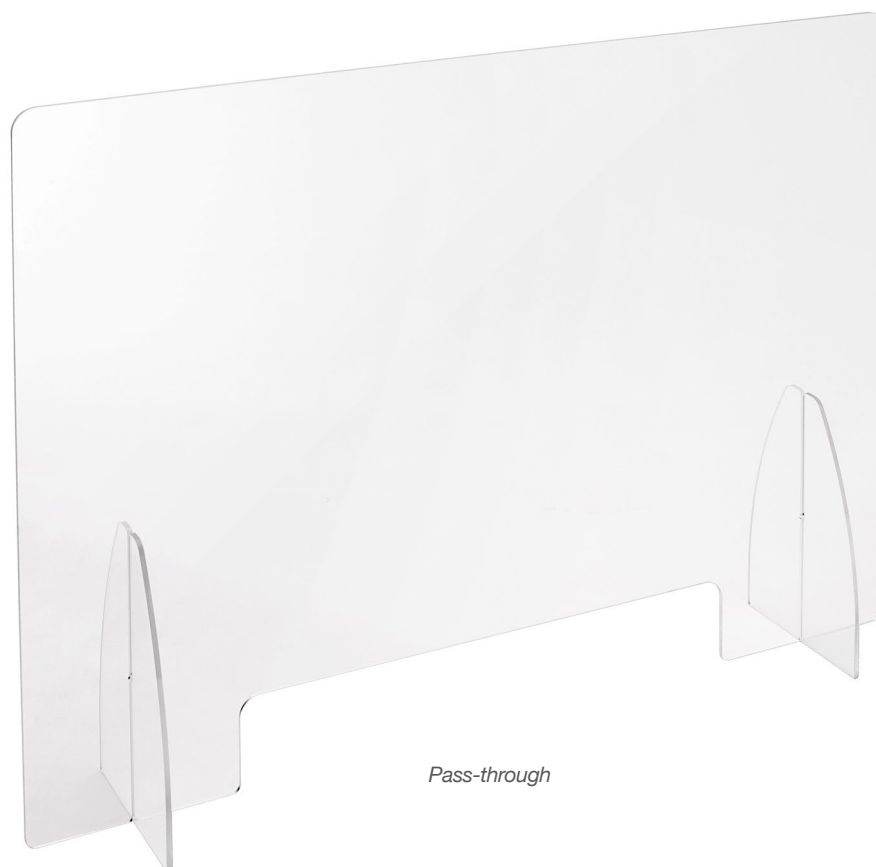

Featured Models

PASS-THROUGH :: \$326

24" x 36" acrylic screen, pass-through, round feet

NO PASS-THROUGH :: \$326

24" x 36" acrylic screen, no pass-through, round feet

Features

- 1-on-1 transaction screens sit ready to protect during quick interactions and small get togethers
- Quick and easy tabletop installation means you can provide protection in seconds
- Clear acrylic allows for safe social interactions
- High-performing, resilient acrylic surfaces can withstand some of the most powerful cleaners and disinfectants, including a full range of EPA-approved COVID-19 products.
- Lightweight material offers greater resistance to impact compared to glass alternatives.
- Available with three different foot styles
- Option a 4" tall pass-through

1. Product

Product Type	Code	Price
Tabletop Screen	3096	Priced by Size

Screen Type	Code	Price
Transaction	TRSC	Priced by Size

2. Material

Material Type	Code	Price
Clear Acrylic	DT101C	Priced by Size

3. Size

Size (H x W)	Code	Price
24" Width		
24" x 24"	SCH24 SCW24	\$239
30" x 24"	SCH30 SCW24	\$287
36" x 24"	SCH36 SCW24	\$330
42" x 24"	SCH42 SCW24	\$354
30" Width		
24" x 30"	SCH24 SCW30	\$281
30" x 30"	SCH30 SCW30	\$337
36" x 30"	SCH36 SCW30	\$361
42" x 30"	SCH42 SCW30	\$412

3. Size (Cont.)

Size (H x W) (Cont.)	Code	Price
36" Width		
24" x 36"	SCH24 SCW36	\$326
30" x 36"	SCH30 SCW36	\$347
36" x 36" (Coming Soon)	SCH36 SCW36	\$382
42" x 36"	SCH42 SCW36	\$445
48" Width		
24" x 48"	SCH24 SCW48	\$361
30" x 48"	SCH30 SCW48	\$379
36" x 48" (Coming Soon)	SCH36 SCW48	\$398
42" x 48"	SCH42 SCW48	\$481

4. Appearance

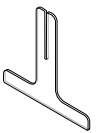
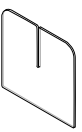
Foot Style	Code	Price	
Round-Shaped	SF1	+ \$0	
T-Shaped	SF2	+ \$0	
Square Shaped	SF3	+ \$0	

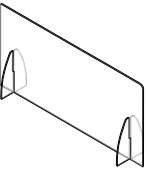
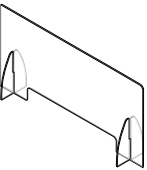
Pass-Through	Code	Price	
No Pass-Through	NPT	+ \$0	
Pass-Through	PTI	+ \$0	

Sector

TRI-FOLD ACRYLIC MEETING AND SINGLE-TABLE SCREEN

Partition and protect.

Partition and protect. Now more than ever, our shared spaces should be safe—free from contagions, concerns and anything that gets in the way of interacting. This collection of acrylic tabletop screens provides the protection and peace of mind you need to meet with confidence.



Featured Models

SINGLE TABLE :: \$326

24" x 36" acrylic screen, pass-through, round feet

MEETING :: \$326

24" x 36" acrylic screen, no pass-through, round feet

TRI-FOLD ACRYLIC MEETING AND SINGLE-TABLE SCREENS

Features

- From individual desks to large board rooms, tri-fold meeting screens are personal, mobile and adapt to the busy classroom or office easily
- Single-table tri-fold screens conveniently match common tabletop sizes; tri-fold meeting screens allow you to subdivide larger meeting tables.
- High-performing, resilient acrylic surfaces can withstand some of the most powerful cleaners and disinfectants, including a full range of EPA-approved COVID-19 products.
- Clear acrylic allows for safe social interactions
- Lightweight material offers greater resistance to impact compared to glass alternatives.

1. Product

Product Type	Code	Price
Tabletop Screen	3096	Priced by Size
Product Style	Code	Price

Tri-Fold Screen

TFSC

Priced by Size

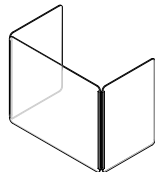

2. Material

Material	Code	Price
Clear Acrylic	DT101C	Priced by Size

3. Size

Table Size (D x W)	Code	Price
Tri-Fold Single-Table, 24" Height		
18" x 48"	SCH24 SCW46 SCD17	\$394
18" x 60"	SCH24 SCW58 SCD17	\$654
24" x 48"	SCH24 SCW46 SCD23	\$494
24" x 60"	SCH24 SCW58 SCD23	\$755
30" x 48"	SCH24 SCW46 SCD29	\$553
30" x 60"	SCH24 SCW58 SCD29	\$831
Tri-Fold Single-Table, 30" Height		
18" x 48"	SCH30 SCW46 SCD17	\$649
18" x 60"	SCH30 SCW58 SCD17	\$954
24" x 48"	SCH30 SCW46 SCD23	\$815
24" x 60"	SCH30 SCW58 SCD23	\$1,197
30" x 48"	SCH30 SCW46 SCD29	\$834
30" x 60"	SCH30 SCW58 SCD29	\$1,341
Tri-Fold Meeting, 24" Height		
17" x 29"	SCH24 SCW29 SCD17	\$372
17" x 46"	SCH24 SCW46 SCD17	\$394
17" x 58"	SCH24 SCW58 SCD17	\$654
20" x 29"	SCH24 SCW29 SCD20	\$385
20" x 46"	SCH24 SCW46 SCD20	\$441
20" x 58"	SCH24 SCW58 SCD20	\$719
23" x 29"	SCH24 SCW29 SCD23	\$399
23" x 46"	SCH24 SCW46 SCD23	\$494
23" x 58"	SCH24 SCW58 SCD23	\$755
29" x 29"	SCH24 SCW29 SCD29	\$413
Tri-Fold Meeting, 30" Height		
17" x 29"	SCH30 SCW29 SCD17	\$558
17" x 46"	SCH30 SCW46 SCD17	\$649
17" x 58"	SCH30 SCW58 SCD17	\$954
20" x 29"	SCH30 SCW29 SCD20	\$624
20" x 46"	SCH30 SCW46 SCD20	\$760
20" x 58"	SCH30 SCW58 SCD20	\$1,069
23" x 29"	SCH30 SCW29 SCD23	\$699
29" x 29"	SCH30 SCW29 SCD29	\$750

On single-table tri-fold screens, the screen depth is 1" less than the table's depth and 2" shorter than the table width.

For instance: A 24" x 48" Tabletop has a screen with an actual size of 23" x 46".

MEETING TABLE COMPATIBILITY CHART

Screen Size (D x W)	Code	Seats Supported
36" x 72" Conference Table		
17" x 29"	SCH24 SCW29 SCD17	2 Seats Per Side
17" x 46"	SCH24 SCW46 SCD17	1 Seat Per Side
17" x 58"	SCH24 SCW58 SCD17	1 Seat Per Side
42" x 84" Conference Table		
20" x 29"	SCH24 SCW29 SCD20	2 Seats Per Side
20" x 46"	SCH24 SCW46 SCD20	1 Seat Per Side
20" x 58"	SCH24 SCW58 SCD20	1 Seat Per Side
48" x 96" Conference Table		
23" x 29"	SCH24 SCW29 SCD23	3 Seats Per Side
23" x 46"	SCH24 SCW46 SCD23	2 Seats Per Side
23" x 58"	SCH24 SCW58 SCD23	1 Seat Per Side
29" x 29"	SCH24 SCW29 SCD29	1 Seat Per Side

Monitor Arms

SINGLE POLE | DUAL POLE | TRIPLE POLE
SINGLE DESK | DUAL DESK
HEAVY DUTY | DUAL ARRAY

Statement of Line

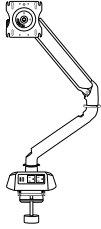

King Cobra
Light Duty Single Screen Arm
3101 MAT02..... 477

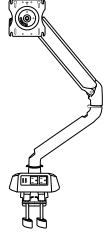

King Cobra
Heavy Duty Single Screen Arm
3101 MAT02..... 477

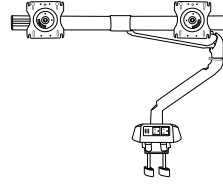

King Cobra
Heavy Duty Dual Array
MAT03..... 477

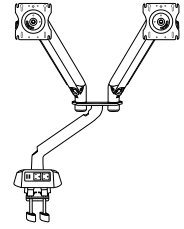

King Cobra
Heavy Duty Dual Screen High-Splitter
3101 MAT04..... 477

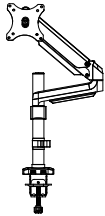

Mobio
Single Pole Monitor Arm
3210 MAT30..... 478

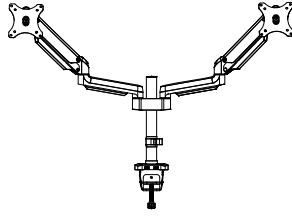

Mobio
Dual Pole Monitor Arm
3210 MAT31..... 478

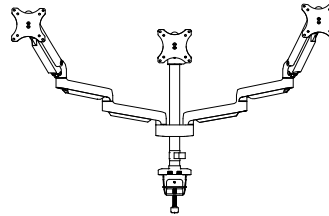

Mobio
Triple Pole Monitor Arm
3210 MAT32..... 478

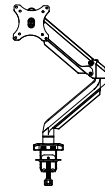

Mobio
Single Desk Monitor Arm
3210 MAT33..... 478

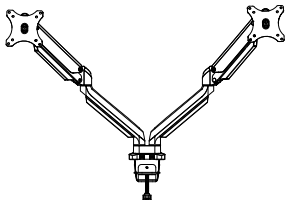

Mobio
Dual Desk Monitor Arm
3210 MAT34..... 478

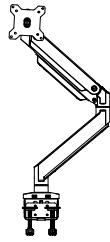

Mobio
Heavy Duty Single Desk Monitor Arm
3210 MAT35..... 478

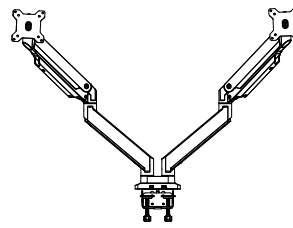

Mobio
Heavy Duty Dual Desk Monitor Arm
3210 MAT36..... 478

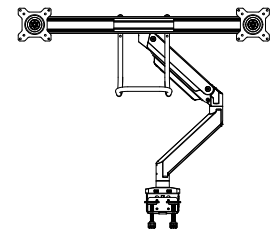

Mobio
Heavy Duty Dual Array Monitor Arm
3210 MAT37..... 478

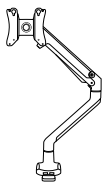

Unity G2
Single
3111 MAT06..... 482

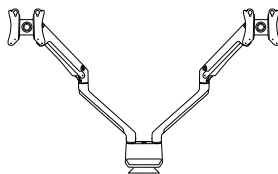

Unity G2
Dual
3111 MAT07..... 482

King Cobra

MONITOR ARM

Charmed by design.

Strike at the heart of productivity with the King Cobra collection of monitor arms. Sleek design, smooth operation, unmatched performance and rugged reliability combine to meet the demands of today's modern office.

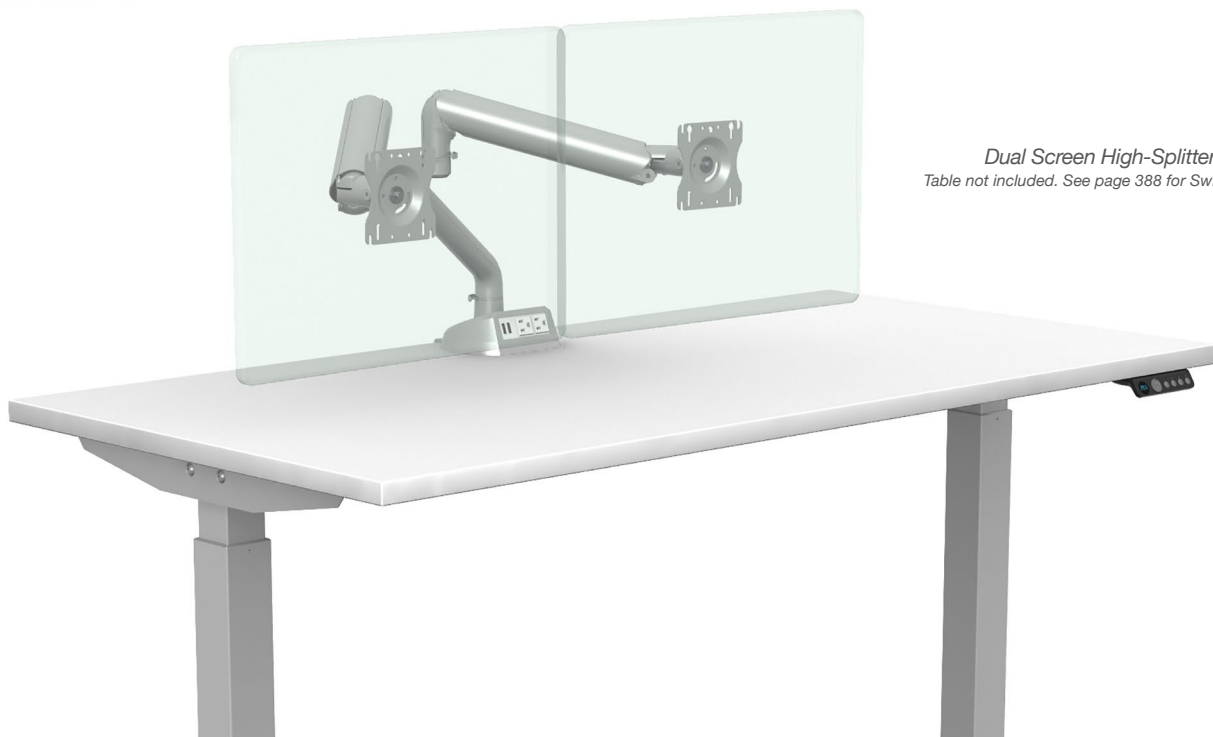

Dual Screen High-Splitter
Table not included. See page 388 for Switchback.

Featured Models

SINGLE SCREEN :: \$495

Light duty single screen monitor arm

DUAL SCREEN HIGH-SPLITTER :: \$725

Heavy duty dual screen high splitter monitor arm

Features

- Die-cast aluminum construction provides greater stability and contains high-recycled material
- A variety of foldable, gas-type arms in light duty, heavy duty and high-splitter configurations
- Portrait and landscape view-adjustable quick-release VESA
- Available in four configurations: Single, HD Single, HD Dual Array and HD Dual High Splitter
- Features two power and two USB outlets
- Adjustable rotation limiter helps restrict arm rotation to 180 degrees
- Includes clamp and grommet mount
- Installs easily with clamp mount and 10-ft power cord

SPECIFICATIONS: SINGLE SCREEN

Model:	MAT01 Light Duty Single Screen	MAT02 Heavy Duty Single Screen
Height	7.63"-22.13"	7.63"-22.13"
Max Arm Extension	24.75"	24.75"
Table Top Thickness	0.39"-1.62"	0.39"-1.62"
VESA	75 mm, 100 mm	75 mm, 100 mm
Power Outlet	120 V	120 V
USB Port	5 V 2.1 Amp	5 V 2.1 Amp
Weight Capacity Warranty	5-20 lb	10-30 lb

SPECIFICATION: DUAL SCREEN

Model:	MAT03 Heavy Duty Dual Array	MAT M04 Heavy Duty Dual Screen High-Splitter
Height	8.43"-22.93"	7.93"-22.43"
Max Arm Extension	29.77"	13.67"
Top Table Thickness	0.39"-1.62"	0.39"-1.62"
VESA	75 mm, 100 mm	75 mm, 100 mm
Power Outlet	120 V	120 V
USB Port	5 V 2.1 Amp	5 V 2.1 Amp
Max Monitor Width	23"	27"
Weight Capacity Warranty (Per Screen)	6-28 lb	10-30 lb

MONITOR ARM

1. Product

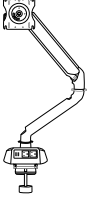
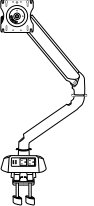
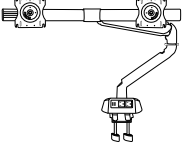
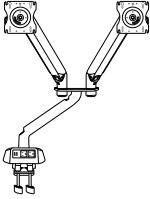
Product Type	Code	Price	
Light Duty Single Screen	3101 MAT01 MAC01	\$495	
Heavy Duty Single Screen	3101 MAT02 MAC01	\$520	
Heavy Duty Dual Array	3101 MAT03 MAC01	\$580	
Heavy Duty Dual Screen High-Splitter	3101 MAT04 MAC01	\$725	

Mobio

MONITOR ARM

Experience unmatched performance.

When you're hard at work, you need a workspace that works hard for you. With a wide range of motion and ultra-reliability, Mobio is your go-to solution for a family of monitor arms to maximize your space. Its compact design and die cast aluminum construction mean greater stability, flexibility and unmatched performance.



*Dual Desk Monitor Arm
Table not included. See page 384 for Switchback.*

Featured Models

SINGLE DESK :: \$243

Mobio single desk monitor arm

DUAL DESK :: \$485

Mobio dual desk monitor arm

DUAL ARRAY HD :: \$562

Mobio heavy duty dual array monitor arm



Features

- Includes surface clamp and grommet mount, ideal for all desk mounting configurations
- Choose from Mobio arms in single desk, dual desk and pole-mount configurations
- Choose from Mobio HD arms in single desk, dual desk and dual-array configurations
- Compact aluminum arm design maximizes desktop space
- Die-cast aluminum construction ensures stability and performance
- Gas spring mechanism delivers smooth vertical adjustment
- Built-in spring tension gauge enables perfect weight adjustment
- Installs easily with quick-release VESA plate
- Two pass-through USB ports come standard

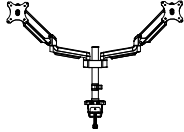
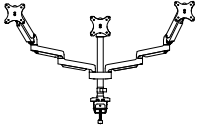

MONITOR ARM

1. Product

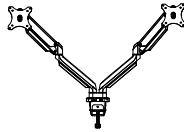
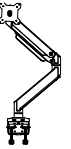
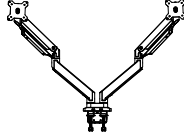
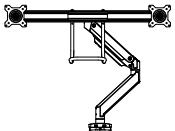
Product Style	Code	Price	
Mobio			
Single Pole Monitor Arm	3210 MAT30	\$309	
Dual Pole Monitor Arm	3210 MAT31	\$557	
Triple Pole Monitor Arm	3210 MAT32	\$646	
Single Desk Monitor Arm	3210 MAT33	\$243	
Dual Desk Monitor Arm	3210 MAT34	\$485	
Mobio HD			
Heavy Duty Single Desk Monitor Arm	3210 MAT35	\$378	
Heavy Duty Dual Desk Monitor Arm	3210 MAT36	\$849	
Heavy Duty Dual Array Monitor Arm	3210 MAT37	\$562	

2. Accessories

Options	Code	Price
No Accessories	MAA00	+ \$0
Laptop Tray	MAA03	+ \$99

3. Monitor Arm Finish

Paint Color	Code	Price
Silver	MAC01	+ \$0
Black	MAC03	+ \$0

HD models are available in silver (MAC01) finish only.

SPECIFICATIONS: POLE ARMS

	MAT30 Single Pole	MAT31 Dual Pole	MAT32 Triple Pole
Max Monitor Size	17"-32"	17"-32"	17"-27"
Max Arm Extension	23.16"	21.3"	28.58"
Table Top Thickness	0.39"-2.17"	0.39"-2.17"	0.39"-2.17"
Pole Height	12.58"	12.58"	18.09"
VESA	75 mm 100 mm	75 mm 100 mm	75 mm 100 mm
Weight Capacity (Per Screen)	3.3-17.6 lb	3.3-17.6 lb	3.3-17.6 lb

MONITOR ARM

SPECIFICATIONS: DESK ARMS

	MAT33 Single Desk	MAT34 Dual Desk
Max Monitor Size	17"-32"	17"-32"
Max Arm Extension	20.72"	20.72"
Height Range	5.31"-16.34"	5.31"-16.34"
Table Top Thickness	0.39"-2.17"	0.39"-2.17"
VESA	75 mm 100 mm	75 mm 100 mm
Weight Capacity (Per Screen)	3.3-17.6 lb	3.3-17.6 lb

SPECIFICATIONS: HEAVY DUTY ARMS

	MAT35 Single Desk HD	MAT36 Dual Desk	MAT37 Dual Array
Max Monitor Size	17"-35"	17"-35"	17"-32"
Max Extension	23.49"	23.49"	12.68"
Height Range	10.03"-23.03"	10.03"-23.03"	10.43"-23.43"
Table Top Thickness	0.39"-2.04"	0.39"-2.04"	0.39"-2.04"
VESA	75 mm 100 mm	75 mm 100 mm	75 mm 100 mm
Weight Capacity (Per Screen)	2.2-33 lb	2.2-33 lb	2.2 lb-17.6 lb

Unity G2

MONITOR ARM

Altogether powerful.

Be one with your work. Our Unity G2 family of monitor arms combine reliable utility with rugged design to create the perfect solution for any workspace.



Single Monitor Arm
Table not included. See page 410 for Tensor.

Featured Models

SINGLE :: \$249

Unity G2 single monitor arm, white finish

DUAL :: \$499

Unity G2 dual monitor arm, silver finish

Features

- Gas height-adjustable
- 12 inches of lift
- 180-degree pan and 360-degree rotation

1. Monitor Arms

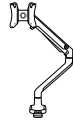
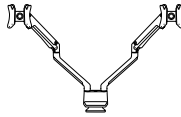
Product Type	Code	Price	
Single	3111 MAT06	\$249	
Dual	3111 MAT07	\$499	

2. Monitor Arm Finish

Paint Color	Code	Price
Silver	MAC01	+ \$0
White	MAC02	+ \$0

SPECIFICATIONS

	3111 MAT06 Single-Monitor	3111 MAT07 Dual-Monitor
Max Screen Size	N/A	17" – 29"
Max Extension	20.92"	20.92"
Height Range	6.9"–18.9"	7.6"–19.4"
VESA	75 mm, 100 mm	75 mm, 100 mm
Table Top Thickness	0.39"–1.5"	0.39"–1.5"
Weight Capacity (Per Arm)	4.4–17.6 lb	4.4–17.6 lb

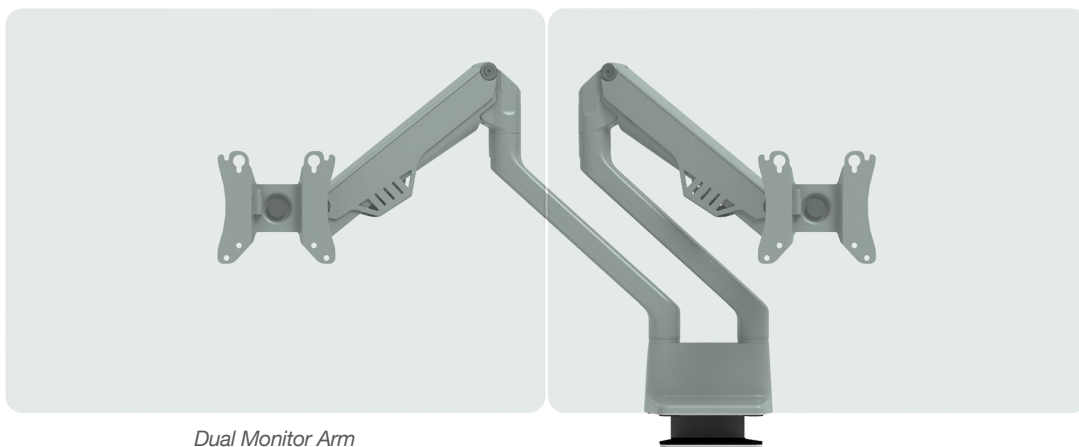

Dual Monitor Arm

Accessories

STORAGE | POWER | LIGHTING
KEYBOARD TRAY | WIRE MANAGEMENT
DESKTOP SIT-TO-STAND
ANTI-FATIGUE MAT

Anti-Fatigue Mat

Soft and supportive.

Promote well-being while ensuring productivity. Our anti-fatigue mat help you stand (and work) longer—pairing well with our collections of height-adjustable tables and desktop workstations.



Anti-Fatigue Mat

Product	Code	Price	
20" x 30" Black Anti-Fatigue Mat	3153 AFM01	\$150	

Features and Specifications

- Provides premium ergonomic comfort
- Can reduce fatigue from standing up to 50%
- Durable single-piece construction
- 100% polyurethane integral skin design
- 20" (D) x 30" (W)
- 5-year warranty

CPU Storage

Keep it clean.

Secure your PC with ease. Our CPU holder that attaches to your workstation for a cleaner look.

CPU Under Desk/Wall Mount



CPU Storage Band



1. Product

Product	Code	Price	
CPU Storage Band	3156 CPUS1	\$201	
CPU Under Desk/Wall Mount	3156 CPUS3	\$100	

Features and Specifications

BAND

- Supports most PC sizes (up to 64" in perimeter)
- Retracts on a 17" track with 360-degree swivel
- Quick and easy adjustments with an Allen key
- Weight capacity warranty: Up to 75 lb

UNDER DESK/WALL

- Slide-and-swivel movement makes adjustment easy
- Features a 17" track
- Supports sizes 3.75"-10.5" (W) × 16.5"-24" (H)

Keyboard Tray

GSA SIN #: 33721

Lift, tuck and type.

Free up your workspace with our collection of convenient keyboard platforms and platform connectors.

Mini Trackless With Lift and Lock Mechanism



Features and Specifications

LIFT AND LOCK

- Lift and lock provides 7 inches of height adjustment
- Includes knob for manual tilt adjustment
- 21.75" track

PREMIUM LIFT AND LOCK

- Lift and lock height adjustment with automatic tilt adjustment
- Patented height and tilt indicator
- 21.75" track

MINI TRACKLESS

- Designed to attach and function without a track
- Easily attaches below top to avoid crossbar interference

SIT-TO-STAND

- Lift and lock height adjustment with height range from 8" above the track to 6" below
- Control for tilt adjustment
- 23" track

1. Keyboard Tray

Product Type	Code	Price
Keyboard Tray	3151	\$0

2. Mechanism

Mechanism	Code	Price
None	KBM00	\$0
HAT	KBM01	\$107
Lift and Lock	KBM02	\$181
Mini Trackless	KBM04	\$234
Premium Lift and Lock	KBM05	\$247
Sit-to-Stand	KBM06	\$319

3. Platform

Platform Style	Code	Price
None	KBP00	+ \$0
Laptop Tray	KBP01	+ \$110
Longboard	KBP02	+ \$192
Mini Platform	KBP03	+ \$232
Crescent Board	KBP04	+ \$224
Tilt, Swivel Board	KBP05	+ \$215

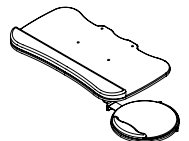
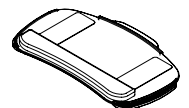
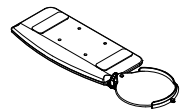
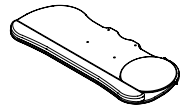
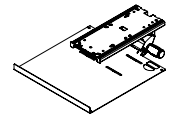

4. Miscellaneous

Options	Code	Price
None	KBO00	+ \$0
U-Brackets for Crossrails	KBTA	+ \$80
Corner Sleeve	KBCS	+ \$142

Laptop Storage

GSA SIN #: 33721

Support and store.

Declutter, declutter. If you're tight on space or need to shift gears, our laptop storage is your go-to solution for an extra hand. These add-ons install under your desk and adjusts left to right to fit your work needs.

1. Product

Product Style	Code	Price	
Laptop Drawer	3154 LPT01	\$290	
Laptop Tray	3154 LPT02	\$217	

Features and Specifications

LAPTOP DRAWER

- 18.28" (W) × 22.28" (L) × 3.64" (H)
- Steel construction
- Enough space to also accommodate a docking station

LAPTOP TRAY

- Adjusts left to right to fit in tight places
- Includes mechanism, track and mounting hardware
- Platform: 15" (W) × 15" (L)
- Desk attachment: 5.77" (W) × 12.75" (L)
- Available in black finish only



Laptop Drawer

Lighting: Rhythm

A bright idea.

Promote bright ideas at every workstation with our value series lighting. It's sleek, simple and turns on with the wave of a hand.



28" Rhythm Lighting

1. Product

Product Type	Code	Price	
Lighting	3140	\$218	

Product Style	Code	Price	
28" Standard	LSV LFSV	+ \$0	
28" Daisy Chain Starter	LSV LFDV	+ \$55	

2. Add-On Light Fixtures

Quantity	Code	Price	
None	LFAV0	+ \$0	
One 28" Daisy Chain	LFAV1	+ \$189	
Two 28" Daisy Chain Starters	LFAV2	+ \$378	

3. Motion Sensor

Sensor	Code	Price	
None	LMS0	+ \$0	
Lighting With Motion Sensor	LMS1	+ \$95	

Features and Specifications

- Motion-activated power button
- Built-in 12-hour automatic shut-off feature
- Mounts allow for infinite tilt adjustment for focusing the light
- LED-rated lifespan: 50,000 hours
- Color temperature: 2800K
- Dimmer: 3 settings; motion-activated
- Brightness adjustability: 100%–50% in 3 stages
- Color finish: silver aluminum with black end caps
- Housing material: clear anodized aluminum
- With mounts: 1.81" (W) × 28.07" (L) × 1.80" (H)
- Cord length: 6 feet with single unit power supply or 6 feet with daisy chain power supply
- 5 feet of interconnecting cables
- Both wood screw and magnet mounts included

Mobile Pedestal

STORAGE SOLUTION

File with flexibility.

Our two-drawer mobile pedestal stores everything you need and can move out of the way while still being within reach.

Mobile Pedestal With Upholstered Pad



Featured Models

NO UPHOLSTERED PAD :: \$283

Mobile pedestal, silver finish, no upholstered pad

WITH UPHOLSTERED PAD :: \$393

Mobile pedestal, white finish, upholstered pad, grade 1 textile

Features

- Five base wheels provide easy mobility
- Recessed pulls mean flat surfaces for safer work areas
- Optional cushion with colorful upholstery options
- Full extension drawer slides
- Compatible with legal and letter file sizes
- Silver, black and white finish options
- Drawer tested at 50,000 pull cycles

1. Product

Product Type	Code	Price
Mobile Pedestal	3150	\$283

Product Style	Code	Price
---------------	------	-------

No Upholstered Pad CPT00 +\$0

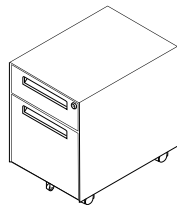

Upholstered Pad CPT01 +\$110

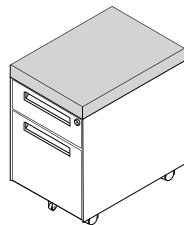

2. Pedestal Finish

Paint Color	Code	Price
Silver	PDC01	+\$0
White	PDC02	+\$0
Black	PDC03	+\$0

3. Material

Material Grade	Code	Price
Fabric/Vinyl Grade 1	FG1	+\$0
Fabric/Vinyl Grade 2	FG2	+\$11
Fabric/Vinyl Grade 3	FG3	+\$30
Fabric/Vinyl Grade 4	FG4	+\$52
Fabric/Vinyl Grade 5	FG5	+\$90
Fabric/Vinyl Grade 6	FG6	+\$127
Fabric/Vinyl Grade 7	FG7	+\$165

SPECIFICATIONS

	3150 Mobile Pedestal
Height	19.25"
Width	14.25"
Length	19.625"
Cushion Height	1.8"
Drawer Weight Capacity	88 lb
Stationary Weight Capacity (Including Weight of Drawer Contents)	250 lb

Mobile Pedestal With No Upholstered Pad



Pencil Storage

Store and more.

When it comes to storing pens, pencils and more, our supply drawers are the "write" way to go—keeping everything organized and within reach.



Half Moon Pencil Drawer

1. Product

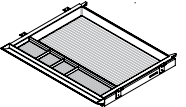
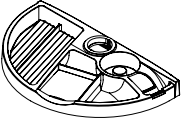
Product Style	Code	Price	
Rectangular Pencil Drawer	3155 PDT01	\$102	
Half Moon Pencil Drawer	3155 PDT02	\$86	

Features and Specifications

- Divided storage compartments for pens, pencils and other small supplies
- Includes easy-to-follow assembly instructions

HALF MOON

- 8.23" (W) × 13.6" (L) × 1.35" (H)
- Drawer extends 11.5"

RECTANGULAR

- 18.125" (W) × 22.75" (L) × 1.94" (H)
- Drawer extends 11.5"

Power: Current

GSA SIN #: 33721

Plug into productivity.

Our Current power module provides the charge you need to stay on task all day long.



Current Surface Camp Mount

1. Current Collection

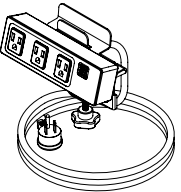
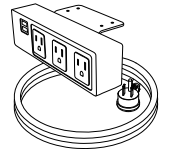
Product Type	Code	Price	
Surface Clamp Mount	3130 PCC	\$199	
Undermount Bracket	3130 PCU	\$228	

2. Color

Module and Cord Color	Code	Price	
White	PC4	+ \$0	
Black	PC1	+ \$0	

Features and Specifications

- Three outlets, 2 USB ports
- White finish features 3.1 amp; black finish comes with 2.1 amp
- Convenient tablet or phone holder built into clamp mount
- 15 amp, 125 volt
- Cord: 10 feet
- Surge protection: 510 joules
- Two USB charging ports; 3.1A combined
- UL/cUL listed (UL962A)

Sit-to-Stand: High Tide

Elevate your task.

Our High Tide offers an easy-to-install solution for converting desktops into an adaptable sit-to-stand, height-adjustable workstation.

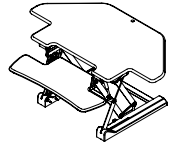
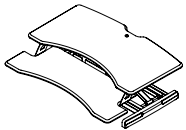

1. High Tide

Model	Code	Price	
High Tide Corner Unit	3120 SSHT1	\$482	
High Tide 4	3120 SSHT4	\$407	

2. Monitor Arms

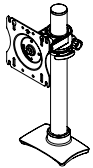
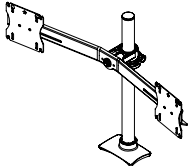
Sit/Stand Monitor Arm	Code	Price	
None	MAT00	+ \$0	
Single Screen	MAT25	+ \$257	
Dual Screen	MAT26	+ \$311	

Features and Specifications

- Infinite height-adjustment increments with lockable gas spring and a height-adjustable range of up to 19.25"
- Desktop size is 17.8" (W) x 32.5" (L);
Keyboard tray size is 6.6" (W) x 32.25" (L);
Overall size is 25.04" (W) x 32.62" (L)
- Desktop supports up to 33 lb;
Keyboard tray supports 4.4 lb
- Single monitor arm weight limit is 20 lb;
Dual monitor arm weight limit is 10 lb per monitor
- Dual monitor arm supports screens up to 22" (W)
- Single monitor arm pole is 12.59" (H);
Dual monitor arm pole is 16.59" (H)
- Desktop material is HDF with CARB certification



Wire Management

GSA SIN #: 33721 | 3152 WM01, 3152 WM03, AND 3152 WM02 ONLY

Clear the cable clutter.

Features and Specifications

J CHAN WITH POWER STRIP

- 4.93" (W) × 36" (L) × 6" (H);
Channel: 3.85" (W) × 36" (L) × 2" (H);
Desk attachment: 1" (W)
- Power strip: 15 amp/125 volt with 8' cord
- 15A on/off switch with built-in circuit breaker
- Surge protection: 450 Joules, LED indicator
- UL listed

WIRE BASKET WITH POWER STRIP

- Silver and black finish options
- 6.13" (W) × 26.07" (L) × 6.36" (H);
Power strip platform: 4.81" wide
- Power strip: 15 amp/125 volt with 8-foot cord
- 15A on/off switch with built-in circuit breaker
- Surge protection: 450 Joules, LED indicator
- UL listed



WIRE CHANNEL

- Black finish only
- 2.50" (W) × 49" (L) × 1.13" (H);
Wire channel: 1.59" (W)
- 6" (W) × 26" inches (L) × 6" (H)

HORIZONTAL WIRE MANAGEMENT

- Includes three wire management pieces
- Place these grips anywhere you need cable control
- Easy installation with four screws
- Adjusts to different positions with ease

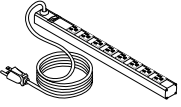
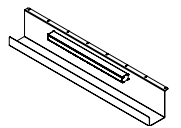
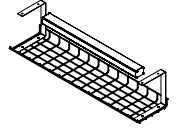
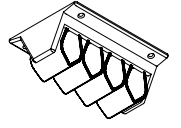
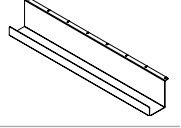
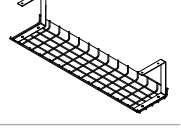
1. Wire Management and Power Strip Add-Ons

Product Type	Code	Price	
Power Strip			
Power Strip	3152 PST1 WM00	\$155	
Wire Management With Power			
J Chan With Power	3152 PST1 WM03	\$248	
Wire Basket With Power	3152 PST1 WM05	\$222	
Wire Management Without Power			
Horizontal Wire Management	3152 WM01	\$54	
J Chan Without Power	3152 WM03	\$93	
Wire Basket Without Power	3152 WM05	\$67	
Wire Channel	3152 WM02	\$41	

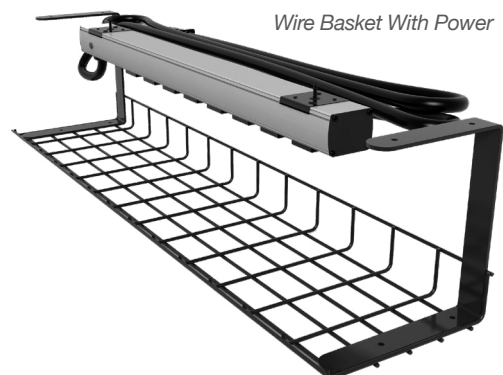

APPENDIX: STAND-ALONE TABLETOPS

GSA SIN #: 33721

1. Table or Desk Top

Product Type	Code	Price
Tabletop or Desktop	3000	Priced by Size

Top Size (Cont.)	Code	Price
------------------	------	-------

2. Size

Top Size	Code	Price
Depth x Width	Round	

42"	TR4242	\$330
48"	TR4848	\$372

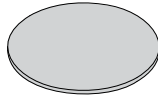

Depth x Width	Square	
30" x 30"	TS3030	\$148
36" x 36"	TS3636	\$213
42" x 42"	TS4242	\$289
48" x 48"	TS4848	\$324

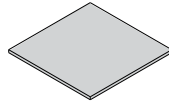

Actual size of 30" x 30" tabletop is 30.75" x 30.75"

Depth x Width	Rectangular	
18" x 42"	TZ1842	\$140
18" x 48"	TZ1848	\$159
18" x 54"	TZ1854	\$179
18" x 60"	TZ1860	\$198
18" x 66"	TZ1866	\$220
18" x 72"	TZ1872	\$239
24" x 36"	TZ2436	\$142
24" x 42"	TZ2442	\$166
24" x 48"	TZ2448	\$189
24" x 54"	TZ2454	\$213
24" x 60"	TZ2460	\$236
24" x 66"	TZ2466	\$261
24" x 72"	TZ2472	\$284
24" x 78"	TZ2478	\$308
24" x 84"	TZ2484	\$331
30" x 36"	TZ3036	\$178
30" x 42"	TZ3042	\$208
30" x 48"	TZ3048	\$236
30" x 54"	TZ3054	\$266
30" x 60"	TZ3060	\$295
30" x 66"	TZ3066	\$325
30" x 72"	TZ3072	\$354
30" x 78"	TZ3078	\$384
30" x 84"	TZ4896	\$825

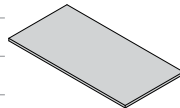

2. Size (Cont.)

Top Size (Cont.)	Code	Price
Depth x Width	Rectangular Conference	

42" x 78"	TZ4278	\$529
42" x 84"	TZ4284	\$570
42" x 90"	TZ4290	\$622
42" x 96"	TZ4296	\$652
48" x 78"	TZ4878	\$606
48" x 84"	TZ4884	\$652
48" x 90"	TZ4890	\$717
48" x 96"	TZ4896	\$747

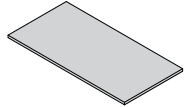

Depth x Width	Right 90-Degree Top	
---------------	---------------------	--

24" x 48"	TBCR2448	\$414
24" x 54"	TBCR2454	\$466
24" x 60"	TBCR2460	\$516
30" x 48"	TBCR3048	\$516
30" x 54"	TBCR3054	\$584
30" x 60"	TBCR3060	\$646

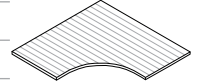

Depth x Width	Left 90-Degree Top	
---------------	--------------------	--

24" x 48"	TBCL2448	\$414
24" x 54"	TBCL2454	\$466
24" x 60"	TBCL2460	\$516
30" x 48"	TBCL3048	\$516
30" x 54"	TBCL3054	\$584
30" x 60"	TBCL3060	\$646

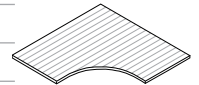

Depth x Width	120-Degree Top	
---------------	----------------	--

24" x 42"	TA2442	\$517
24" x 48"	TA2448	\$728
30" x 42"	TA3042	\$590
30" x 48"	TA3048	\$736

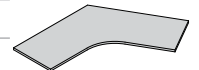

APPENDIX: STAND-ALONE TABLETOPS

GSA SIN #: 33721

2. Size (Cont.)

Top Size (Cont.)	Code	Price	
A x B x C	Right Extended Corner		
24" x 36" x 60"	TXR243660	\$388	
24" x 36" x 66"	TXR243666	\$438	
24" x 36" x 72"	TXR243672	\$495	
24" x 42" x 60"	TXR244260	\$446	
24" x 42" x 66"	TXR244266	\$504	
24" x 42" x 72"	TXR244272	\$569	
24" x 48" x 60"	TXR244860	\$490	
24" x 48" x 66"	TXR244866	\$554	
24" x 48" x 72"	TXR244872	\$626	
30" x 36" x 60"	TXR303660	\$446	
30" x 36" x 66"	TXR303666	\$504	
30" x 36" x 72"	TXR303672	\$609	
30" x 42" x 60"	TXR304260	\$513	
30" x 42" x 66"	TXR304266	\$579	
30" x 42" x 72"	TXR304272	\$655	
30" x 48" x 60"	TXR304860	\$539	
30" x 48" x 66"	TXR304866	\$609	
30" x 48" x 72"	TXR304872	\$689	
A x B x C	Left Extended Corner		
24" x 60" x 36"	TXL246036	\$388	
24" x 66" x 36"	TXL246636	\$438	
24" x 72" x 36"	TXL247236	\$495	
24" x 60" x 42"	TXL246042	\$446	
24" x 66" x 42"	TXL246642	\$504	
24" x 72" x 42"	TXL247242	\$569	
24" x 60" x 48"	TXL246048	\$490	
24" x 66" x 48"	TXL246648	\$554	
24" x 72" x 48"	TXL247248	\$626	
30" x 60" x 36"	TXL306036	\$446	
30" x 66" x 36"	TXL306636	\$504	
30" x 72" x 36"	TXL307236	\$609	
30" x 60" x 42"	TXL306042	\$513	
30" x 66" x 42"	TXL306642	\$579	
30" x 72" x 42"	TXL307242	\$655	
30" x 60" x 48"	TXL306048	\$539	
30" x 66" x 48"	TXL306648	\$609	
30" x 72" x 48"	TXL307248	\$689	

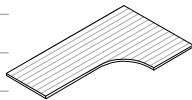
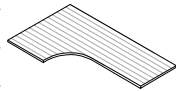

2. Size (Cont.)

Top Size (Cont.)	Code	Price	
A x B x C x D	Right Extended Offset Corner		
24" x 36" x 60" x 30"	OR24366030	\$426	
24" x 36" x 66" x 30"	OR24366630	\$484	
24" x 36" x 72" x 30"	OR24367230	\$549	
24" x 42" x 60" x 30"	OR24426030	\$493	
24" x 42" x 66" x 30"	OR24426630	\$559	
24" x 42" x 72" x 30"	OR24427230	\$635	
24" x 48" x 60" x 30"	OR24486030	\$519	
24" x 48" x 66" x 30"	OR24486630	\$589	
24" x 48" x 72" x 30"	OR24487230	\$669	
A x B x C x D	Left Extended Offset Corner		
30" x 60" x 36" x 24"	OL30603624	\$426	
30" x 66" x 36" x 24"	OL30663624	\$484	
30" x 72" x 36" x 24"	OL30723624	\$549	
30" x 60" x 42" x 24"	OL30604224	\$493	
30" x 66" x 42" x 24"	OL30664224	\$559	
30" x 72" x 42" x 24"	OL30724224	\$635	
30" x 60" x 48" x 24"	OL30604824	\$519	
30" x 66" x 48" x 24"	OL30664824	\$589	
30" x 72" x 48" x 24"	OL30724824	\$669	

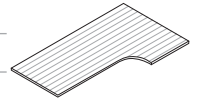
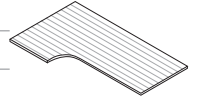

3. Top Finish

Laminate	Code	Price	
Ankara Cherry	TL18	+ \$0	
Black	TL19	+ \$0	
Brazilian Walnut	TL20	+ \$0	
Cabinet Maple	TL21	+ \$0	
Contour White	TL22	+ \$0	
Driftwood	TL23	+ \$0	
Folkstone Grey	TL24	+ \$0	
Libretti	TL25	+ \$0	
Queenston Oak	TL26	+ \$0	
Sandalwood	TL27	+ \$0	
Walnut Amati	TL28	+ \$0	
White	TL29	+ \$0	

APPENDIX: STAND-ALONE TABLETOPS

4. Grommets

Grommet Location	Code	Price	
No Grommets	GP00	+ \$0	
Left Only	GP01	+ \$30	
Center Only	GP02	+ \$30	
Right Only	GP03	+ \$30	
Left and Center	GP04	+ \$60	
Left and Right	GP05	+ \$60	
Right and Center	GP06	+ \$60	
Left, and Center	GP07	+ \$90	

Grommet Color	Code	Price	
Black	GC01	+ \$0	
White	GC02	+ \$0	

Left grommets (GP01/GP04/GP05/GP07) are not available on right extended corners or right extended offset corners.

Right grommets (GP03/GP05/GP06/GP07) are not available on left extended corners or right extended offset corners.

5. Add-Ons

Mending Plate	Code	Price	
None	TTMP0	+ \$0	
Mending Plate Kit	TTMP1	+ \$67	

Stiffner	Code	Price	
No Stiffner	STF00	+ \$0	
54" Stiffener (1 Each)	STF01	+ \$72	
54" Stiffeners (2 Each)	STF02	+ \$144	

Mending plate kits are available with tabletops that have a depth of 20", 24" or 30".

Stiffeners are available with and recommended for tabletops that have a depth of 42" or more and/or a width of 66" or more.

APPENDIX: COLOR PROGRAM

From plastic shell colors to mesh colors to custom match colors, SitOnIt Seating gives designers and specifiers lots of options. The table below shows the color options available by collection. All plastic shell colors are available with a 2-day lead time for production.

Plastics

	Anytime	Baja	Freelance	Ioniq	InFlex	Lumin	Mika	OnCall	Relay	Qwiz	Rio	Rowdy	Wit Side
Apple	—	SC24	—	—	SC24	SC24	—	—	—	—	SC24	SC24	—
Arctic	SC21	SC21	SC21	—	SC21	SC21	—	SC21	SC21	—	SC21	SC21	SC21
Black	SC1	SC1	SC1	SC1	SC1	SC1	SC1	SC1	SC1	SC1	SC1	SC1	SC1
Bisque	—	SC7	—	—	SC7	SC7	—	—	—	—	SC7	SC7	—
Chocolate	SC4	SC4	SC4	—	SC4	SC4	—	SC4	SC4	—	SC4	SC4	SC4
Fog	—	—	—	—	—	—	SC27	—	—	SC27	—	—	—
Lagoon	SC15	SC15	SC15	—	SC15	SC15	—	SC15	SC15	—	SC15	SC15	SC15
Latte	SC20	SC20	SC20	—	SC20	SC20	—	SC20	SC20	—	SC20	SC20	SC20
Lemon	—	SC25	—	—	SC25	SC25	—	—	—	—	SC25	SC25	—
Navy	SC5	SC5	SC5	—	SC5	SC5	—	SC5	SC5	—	SC5	SC5	SC5
Pacific	—	SC22	—	—	SC22	SC22	—	—	—	—	SC22	SC22	—
Red	SC19	SC19	SC19	—	SC19	SC19	—	SC19	SC19	—	SC19	SC19	SC19
Slate	SC8	SC9	SC8	—	SC8	SC9	—	SC8	SC8	—	SC9	SC8	SC9
Sterling	SC18	SC18	SC18	—	SC18	SC18	—	SC18	SC18	—	SC18	SC18	SC18
Tangerine	—	SC23	—	—	SC23	SC23	—	—	—	—	SC23	SC23	—
White	—	—	—	SC26	—	—	SC26	—	—	SC26	—	—	—

APPENDIX: COLOR PROGRAM

The following collections are available in the mesh color program: Amplify, Focus, Focus 2.0, Focus Side, Mavic, Movi, Novo, Qwiz, Torsa, Vectra, Wit and Wit Side. No minimum orders or additional costs apply.

Mesh

	Amplify	Focus	Focus 2.0	Focus Side	Mavic	Movi	Novo	Qwiz	Torsa	Vectra	Wit	Wit Side
Solids												
Apple	MC31	—	MC31	MC31	MC31	MC31	MC31	MC31	—	—	MC31	MC31
Aqua	MC30	—	—	MC30	—	MC30	MC30	MC30	—	—	MC30	MC30
Ash	—	—	MC45	—	—	—	—	—	—	—	—	—
Black	—	MC1	MC1	MC1	—	—	—	—	—	—	—	—
Charcoal	—	—	MC44	—	—	—	—	—	—	—	—	—
Desert	MC9	—	MC9	MC9	MC9	MC22	MC22	MC22	MC9	MC9	MC22	MC22
Dune	—	—	MC46	—	—	—	—	—	—	—	—	—
Electric Blue	MC24	—	MC13	MC24	MC13	MC24	MC24	MC24	—	—	MC24	MC24
Fire	MC10	—	MC10	MC10	MC10	MC25	MC25	MC25	MC10	—	MC25	MC25
Fog	MC7	—	MC7	MC7	MC7	MC23	MC23	MC23	MC7	—	MC23	MC23
Grape	—	—	—	—	—	MC26	MC26	MC26	—	—	MC26	MC26
Lemon	—	—	—	—	—	MC27	MC27	MC27	—	—	MC27	MC27
Midnight	—	—	MC43	—	—	—	—	—	—	—	—	—
Mist	—	—	—	—	—	—	—	—	—	MC41	—	—
Navy	MC8	—	MC8	MC8	MC8	—	—	—	MC8	MC8	—	—
Nickel	MC6	—	MC6	MC6	MC6	MC21	MC21	MC21	MC6	MC6	MC21	MC21
Ocean	—	—	MC29	—	MC29	MC29	MC29	MC29	—	—	MC29	MC29
Onyx	MC5	—	MC5	MC5	MC5	MC20	MC20	MC20	MC5	MC5	MC20	MC20
Platinum	—	—	—	—	—	—	—	—	—	MC42	—	—
Slate	—	MC2	MC2	MC2	—	—	—	—	—	—	—	—
Sand	—	MC3	MC3	MC3	—	—	—	—	—	—	—	—
Tangerine	MC28	—	MC28	MC28	MC28	MC28	MC28	MC28	—	—	MC28	MC28
Stripes												
Desert Stripe	—	—	—	—	—	—	—	—	MC16	—	—	—
Fog Stripe	—	—	—	—	—	—	—	—	MC15	—	—	—
Fog Woven Stripe	—	—	—	—	—	—	—	—	—	—	MC37	—
Freeway	—	MC33	MC33	MC33	—	—	—	—	—	—	—	—
Frost Woven Stripe	—	—	—	—	—	—	—	—	—	—	MC36	—
Impress	—	MC34	MC34	MC34	—	—	—	—	—	—	—	—
Nickel Woven Stripe	—	—	—	—	—	—	—	—	—	—	MC38	—
Onyx Stripe	—	—	—	—	—	—	—	—	MC14	—	—	—
Onyx Woven Stripe	—	—	—	—	—	—	—	—	—	—	MC35	—

APPENDIX: ARM ADJUSTMENTS

SitOnIt Seating offers a wide variety of arm styles and adjustments to accommodate all types of users doing a wide variety of tasks. The general adjustments for each arm type are described below. See the website or the product hang tag for specifics.

Armless

Any discussion of arm styles must begin with armless. Armless chairs and stools are less expensive and are easier to get in and out of. However, they do not provide ergonomic support for long-term sitting and task functions.

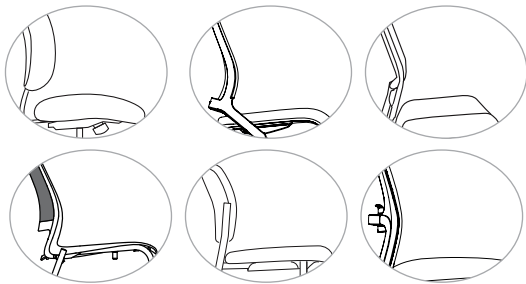

Most chairs and stools are available armless, but the selection may be limited to specific models. For instance, Freelance multipurpose chairs and stools can be specified armless, but not Freelance bariatric chairs.

Fixed

As the name implies, fixed arms cannot be adjusted. Also known as loop arms, cantilever arms and other names, these arms are commonly found on side and multi-seating as well as basic task seating.



Height-Adjustable

This is the most basic adjustable arm. The arm adjusts up or down. Height-adjustable arms are best for basic task work.

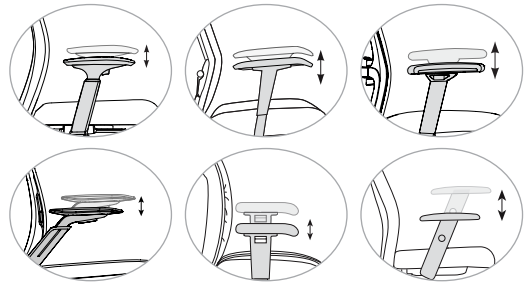

INSTRUCTIONS:

Glove Active, Knack, Non-Stop Heavy Duty, ReAlign, TR2 and Vectra

- To increase or decrease the arm height, press the button and pull up or push down on the arm.

Amplify, Focus, Focus 2.0, Vectra and Wit

- To increase arm height, press the button located under the front of the arm pad and pull the arm up.
- To decrease arm height, press the button located under the front of the arm pad and push the arm down.

Height-adjustable arms are available for Amplify, Focus, Focus 2.0, Glove Active, Knack, Non-Stop Heavy Duty, Novo, ReAlign, TR2, Vectra and Wit.

APPENDIX: ARM ADJUSTMENTS

Height-/Width-Adjustable | Multi-Adjustable

Height-/width-adjustable arms are sometimes called multi-adjustable arms on certain products. The arm adjusts up and down and side to side. This provides more “elbow room” for larger people. Best for basic task work.

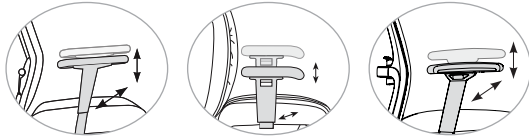

INSTRUCTIONS:

- Height: See instructions in the height-adjustable section.
- Width: To adjust the arm width, push down the lever located under the seat to unlock the width adjustment. Move the arm to the desired width and pull up on the lever to lock the arm in place.

Height-/width-adjustable arms are available for Focus, Glove Active, Knack, Non-Stop Heavy Duty, ReAlign and TR2.

Multi-adjustable arms are available for Amplify, Focus 2.0, Novo, Torsa and Vectra.

Height-Adjustable With Pivot

The arm adjusts up and down and 30-degrees in or out. The arms can be turned in to facilitate writing or keyboarding and turned out for other tasks.

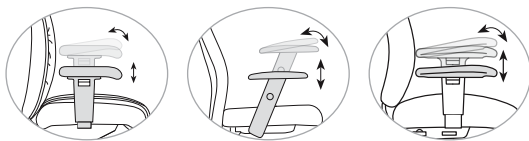

INSTRUCTIONS:

- Height: To increase or decrease the arm height, press the button.
- Pivot: The armrest has three positions: 30-degrees in, center or 30-degrees out. To pivot the arm, grasp the arm pad and move it to one of the three positions.

Height-adjustable arms with pivot are available for Glove Active, ReAlign and TR2.

Height-/Width-Adjustable With Pivot | Multi-Adjustable (Height/Width) With Pivot

This arm adjusts up and down, side to side and 30° in or out.

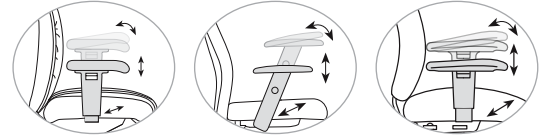

INSTRUCTIONS:

- Height: The arm adjusts up or down. To increase or decrease the arm height, press the button.
- Width: The arm adjusts side to side. To adjust the arm width, push down the lever located under the seat to unlock the width adjustment. Move the arm to the desired width and pull up on the lever to lock the arm in place.
- Pivot: The armrest has three positions: 30° in, center or 30° out (Non-Stop Heavy Duty pivots 15-degrees). To pivot the arm, grasp the arm pad and move it to one of the three positions.

Height-/width-adjustable arms with pivot are available for Glove Active, Non-Stop Heavy Duty, ReAlign and TR2.

Height-Adjustable Break-Away

The arm adjusts up or down and folds down 90-degrees. The folding arm allows for fast and easy ingress and egress and is also great for users with large key rings, tool belts or other personal gear.



INSTRUCTIONS:

- Height: The arm adjusts up or down. To increase or decrease the arm height, press the button.
- Break-Away: To fold the arm back, push down the lever located under the seat to unlock the arm and move the arm back. To return the arm to the original position, pull the arm up until it locks into place.

Height-adjustable break-away arms are available for Non-Stop Heavy Duty (stool only).

APPENDIX: ARM ADJUSTMENTS

Multi-Adjustable (Height/Width) Articulating

The articulating arm adjusts up and down and side to side while the arm pad pivots left and right.

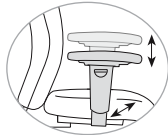

Non-Stop Heavy Duty offers a multi-adjustable articulating arm option.

Fully Adjustable (6-Way)

The six fully adjustable arm adjustments are arm height (up/down), arm pad depth (forward/back) and arm pad side to side (in/out). This ergonomic arm is good for users engaged in a variety of task applications.

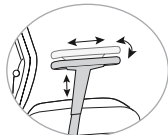

INSTRUCTIONS:

- Height: The arm adjusts up or down. To increase or decrease the arm height, press the button.
- Arm pad depth: The arm pad slides forward or back.
- Width: The arm adjusts side to side.

Fully adjustable (6-way) arms with arm pad depth adjustment are available exclusively on Focus.

Fully Adjustable (6-Way) With Pivot

The six fully adjustable arm adjustments are arm height (up/down), arm pad depth (forward/back) and pivot. This ergonomic arm is good for users engaged in a variety of task applications.

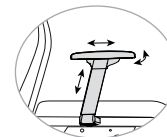

INSTRUCTIONS:

- Height: The arm adjusts up or down. To increase or decrease the arm height, press the button.
- Arm pad depth: The arm pad slides forward or back.
- Pivot: The armrest has three positions: 25° in, center, or 25° out.

Fully adjustable (6-way) arms with pivot are available on Sona and Prava.

Fully Adjustable (8-Way)

The 8-way fully adjustable arms go up/down for height adjustment while the arm pads go forward/back, in/out and pivot in/out for robust support. This all-encompassing arm style makes a perfect fit for today's workplace where broader work applications such as use of smartphones, tablets and other tech accessories are becoming the norm (and require complete forearm support). Pivoting of the arm pads also means that even the most petite of users can adjust accordingly for a more suitable fit.

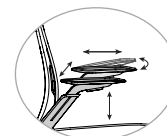

INSTRUCTIONS:

- Height: The arm adjusts up or down. To increase or decrease the arm height, press the button.
- Arm pad depth: The arm pad slides forward or backward.
- Arm pad lateral: The arm pad moves in and out. Not to be confused with the arm width adjustment where the entire arm moves.
- Arm pad pivot: The arm pad pivots in and out to accommodate various work application postures.

Fully adjustable (8-way) arms are available on Focus 2.0 and Vectra.

Fully Multi-Adjustable (10-Way)

The 10-way arm adjustments are arm height, arm width, arm pad depth, arm pad side to side and pivot. This is an excellent ergonomic task chair for executives or workers.



INSTRUCTIONS:

- Height: The arm adjusts up or down. To increase or decrease the arm height, press the button.
- Width: The arm adjusts side to side. To adjust the arm width, push down the lever located under the seat to unlock the width adjustment. Move the arm to the desired width and pull up on the lever to lock the arm in place.
- Arm pad depth: The arm pad slides forward or back.
- Arm pad side to side: The arm pad slides from side to side. Not to be confused with the arm width adjustment where the entire arm moves.
- Pivot: The armrest has three positions: 30-degrees in, center or 30-degrees out. To pivot the arm, grasp the arm pad and move it to one of the three positions.

Fully multi-adjustable (10-way) arms available exclusively on Focus.

APPENDIX: MECHANISM FUNCTIONS

SitOnIt Seating offers a wide range of function levels on our seating products. The descriptions and illustrations below are designed to introduce you to these mechanical functions and their primary advantages.

Standard Synchro (F)

Use for a variety of task environments. This 1.5:1 ratio synchro offers simple features for the budget-conscious buyer.

FEATURES

- Swivels 360°
- Gas cylinder seat height adjustment
- 1.5:1 seat to back synchronized recline movement
- Upright three-position tilt lock
- Tilt tension control
- Anti-kick feature

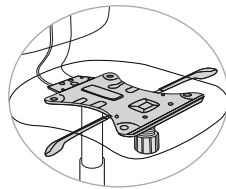

Standard synchro mechanism available on Knack, Novo and Wit.

Enhanced Synchro (Y)

Use for a variety of task positions and extended hours of usage. This 2:1 ratio synchro offers smooth and easy-to-operate adjustments combined with maximum user comfort while ensuring correct posture and support. Allows for a full range of movement.

FEATURES

- Swivels 360°
- Gas cylinder seat-height adjustment
- 2:1 seat to back synchronized recline movement
- Upright two-position tilt lock
- Side tilt tension control
- Anti-kick feature
- Optional seat depth adjustment

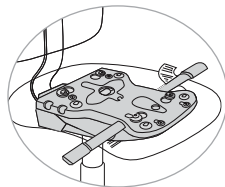

Internal back height adjustment not available on Focus and Prava.

Enhanced Synchro mechanism is available on Amplify, Focus, Focus 2.0, Glove Active, Knack, Prava, ReAlign, Sona and TR2.

Enhanced Synchro with Comfort Drive® (Y/E3)

Ideal for a variety of task positions and extended hours of usage.

This 2:1 ratio synchro offers smooth and easy-to-operate adjustments combined with maximum user comfort while ensuring correct posture and support. Allows for a full range of movement.

FEATURES

- Cable-driven control mechanism
- Swivels 360-degrees
- Gas cylinder seat height adjustment
- 2:1 seat to back synchronized movement
- Easy-to-adjust side activated tension control
- Upright two-position tilt lock
- Anti-kick feature
- Seat depth adjustment

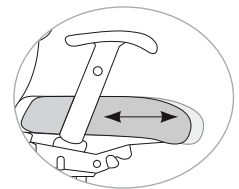

Internal back height adjustment not available on Focus and Prava.

Comfort Drive is available on Focus 2.0, Torsa and Vectra.

Advanced Synchro with Comfort Drive® (L/E3)

Use for today's variety of task positions and usages. Discover easy, intuitive adjustments with easy-to-reach, rapid-adjust controls for ongoing ergonomic support/comfort.

- Rapid-adjust tension knob with five positive clicks; experience tightest to loosest tension in fewer than two turns
- Easy-to-adjust tilt limiter knob with positive clicks; enables tilt-limitation and continuous support in five positions up to 19°
- 2.3:1 ratio synchro
- Swivels 360-degrees
- Built-in seat depth adjustment lever

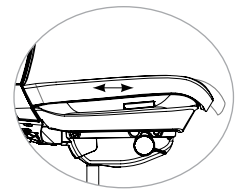

Advanced synchro mechanism available exclusively on Vectra.

APPENDIX: MECHANISM FUNCTIONS

Basic (Swivel Only) (B)

Use for short periods of time. Our most basic control has simple adjustments and works for casual meetings.

- Swivels 360-degrees
- Gas cylinder seat height

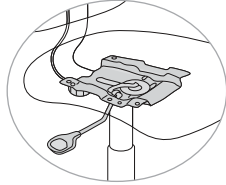

Basic mechanism is available on Anytime, Focus, InFlex, Non-Stop, Novo, OnCall, ReAlign, Relay, TR2 and Wit.

Posture Back (P)

Ideal for shared workstations. Perfect for limited task applications. Independent back articulation ideal for extended stool models.

- Swivels 360°
- Gas cylinder seat height
- Infinite back angle adjustment
- Optional seat-depth adjustment

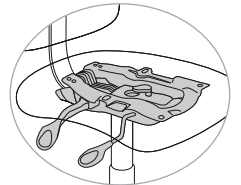

The posture back mechanism is available only on TR2.

Swivel-Tilt (T)

Use for a variety of tasks and conferencing. Lean back and relax, or lock in the upright position and task with solid support.

- Swivels 360°
- Gas cylinder seat height
- Seat and back tilt as unit
- Tilt tension control
- Upright position tilt lock

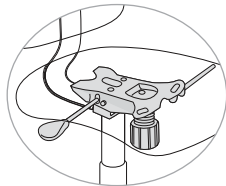

Swivel-tilt mechanism available on Knack, ReAlign and Sona. Swivel tilt mechanism is available on Focus, Focus 2.0, Glove Active, Glove Executive, Knack, Mavic, Non-Stop Heavy Duty, Novo, OnCall, Prava, ReAlign, Relay, Sona and TR2.

Dual Torsion – Heavy Duty (DT)

Use for a variety of tasks and conferencing. Synchronized double-action rise allows full back recline for leg comfort and minimal front rise.

- Swivels 360-degrees
- Gas cylinder seat height
- Seat and back tilt as unit
- Upright position tilt lock
- Tilt tension control
- Reduced rise on front seat edge

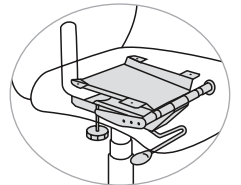

Dual torsion heavy duty mechanism available only on Non-Stop Heavy Duty.

Knee Tilt (K)

Use for executive and managerial positions. The best of traditional tilt performance with a simple locking function. Allows for a full range of movement.

- Swivels 360°
- Gas cylinder seat height
- Seat and back tilt as unit
- Upright position tilt lock
- Tilt tension control
- Reduced rise on front seat edge

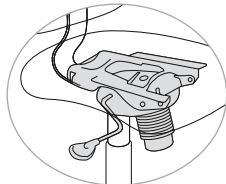

Knee-tilt is available on Focus, Glove Executive, Prava, ReAlign, Sona and TR2.

Multi-Function (M)

Use for a variety of task positions and extended hours of usage. This control allows for an infinite range of movement and adjusts to a 5-degrees forward tilt.

- Swivels 360°
- Gas cylinder seat height
- Infinite back angle adjustment
- Seat and back tilt as unit
- Infinite position tilt lock
- Free floats in unlocked position
- Tilt tension control
- Seat pivots in a 5° forward position
- Optional seat depth adjustment

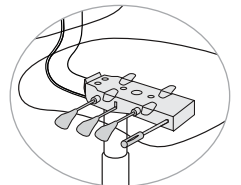

Non-Stop Heavy Duty models have a manual back height adjustment. Multi-function mechanism available on Glove Active, Knack, Non-Stop Heavy Duty, ReAlign and TR2.

Weight-Activated (WA)

Let's replace it with: This control includes a weight-activated back recline tension control and a tilt-limiter function

- Height-adjustment
- Seat depth adjustment
- Recline tension override: if you need more or less tension than the one set by the mechanism automatically
- Tilt limiter sets how far the chair can be reclined

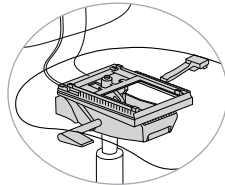

INSTRUCTIONS:

- Recline tilt limiter: The tilt limiter is integrated into the height-adjustment control. Pull the paddle all the way out to lock the chair to a fully upright position. The three grooves in the handle correspond to three tilt ranges. Push the paddle in and the mechanism will subtly click into the groove when adjusted, locking in the range.
- Recline tension override feature: Pull the control out of its stowed position and turn to your right (clockwise from seated position) to increase the amount of tension. The mechanism has a total range of 18 half-turns. The default setting is five half-turns, which is perfect for shared collaborative applications. For longer task applications, try three more halfturns to the right.
- Height-adjustment: Facing forward, the single control paddle is under the seat on the right. Pull up on the paddle to adjust. Stand slightly to raise the seat. Sit to lower the seat.
- Seat slider: While seated, locate the tab on the left side of the chair. Pull lever out to adjust the seat position. Slide seat forward or back to desired setting.

Weight-Activated mechanism available on Mavic.

APPENDIX: EXECUTIVE AND CONFERENCE CHAIR OPTIONS

	GLOVE ACTIVE	GLOVE EXECUTIVE	PRAVA	SONA	TR2 EXECUTIVE
Back Sizes, Styles and Options					
Midback	•	•	•		•
Highback	•	•	•	•	•
Knit Back				•	
Plastic Back					•
Upholstered Back	•	•	•	•	•
Ballistic Nylon	•	•			•
Headrest			•		
Seat Types and Options					
Upholstered Seat	•	•	•	•	•
Seat-Depth Adjustment	•		•	•	•
1" Additional Foam					•
Heavy Duty Series	•				•
Mechanism and Control Options					
Basic (Swivel Only)					•
Enhanced Synchro	•		•	•	•
Knee Tilt		•	•	•	
Multi-Function	•				•
Posture Back					•
Swivel Tilt	•	•	•	•	•
Seat-Depth Adjustment	•		•	•	•
Base Colors and Options					
Black	•	•	•	•	•
Brushed Aluminum Base		•	•	•	•
Silver Metallic			•	•	
Polished Aluminum Base			•	•	
Higher Cylinder				•	
Arm Styles and Options					
Armless	•		•	•	•
Fixed					•
Fixed Loop	•	•	•	•	•
Height-Adjustable	•				•
Height-Adjustable With Pivot	•				•
Multi-Adjustable (Height/Width)	•				•
Multi-Adjustable (Height/Width) With Pivot	•				•
Fully Adjustable (6-Way)			•	•	

APPENDIX: TASK CHAIR OPTIONS

	AMPLIFY	ANYTIME	FOCUS	FOCUS 2.0	INFLEX	IONIQ	KNACK	LUMIN	MAVIC	MOVI
Back Sizes, Styles and Options										
Midback	•		•				•		•	
Highback	•		•	•						
Mesh Back	•		•	•					•	•
Plastic Back		•			•	•		•		
Thintex										
Upholstered Back	•	•	•		•		•	•		
Adjustable Lumbar Support	•		•	•						
Ballistic Nylon							•			
Seat Styles and Options										
Plastic Seat		•			•			•		
Upholstered Seat	•	•	•	•	•	•	•	•	•	•
Seat-Depth Adjustment	•		•	•			•		•	
1" Additional Foam										
Large Seat Cushion	•		•							
Heavy Duty Series	•		•				•			
Mechanisms and Controls										
Basic (Swivel Only)		•			•		•	•		•
Swivel Tilt	•	•	•	•		•	•		•	
Knee Tilt			•							
Posture Back										
Dual Torsion										
Enhanced Synchro	•		•	•			•			
Multi-Function							•			
Weight-Activated With Override									•	
Standard Synchro							•			
Enhanced Synchro With Comfort Drive										
Advanced Synchro									•	
Seat-Depth Adjustment	•		•	•			•		•	
Base Colors and Material Options										
Black Nylon	•	•	•	•	•	•	•	•	•	•
Brushed Aluminum			•				•			
Fog Nylon	•			•						•
Graphite Nylon										
Polished Aluminum	•		•	•		•	•			
White Nylon				•		•			•	•

APPENDIX: TASK CHAIR OPTIONS (CONT.)

	NON-STOP	NOVO	ONCALL	REALIGN	RELAY	RIO	TORSA	TR2	VECTRA	WIT
Back Sizes, Styles and Options										
Midback	•	•		•				•		•
Highback	•	•		•			•	•	•	•
Mesh Back		•					•		•	•
Plastic Back			•		•	•		•		
Thintex										•
Upholstered Back	•		•	•	•	•		•		
Adjustable Lumbar Support		•					•		•	•
Ballistic Nylon	•			•				•		
Seat Styles and Options										
Plastic Seat			•		•	•				
Upholstered Seat	•	•	•	•	•	•	•	•	•	•
Seat-Depth Adjustment		•		•			•	•	•	•
1" Additional Foam								•		
Large Seat Cushion	•	•								
Heavy Duty Series	•	•		•				•		
Mechanisms and Controls										
Basic (Swivel Only)		•	•	•	•	•		•		•
Swivel Tilt	•	•	•	•	•			•		•
Knee Tilt				•						
Posture Back								•		
Dual Torsion	•									
Enhanced Synchro				•				•	•	
Multi-Function	•			•				•		
Weight-Activated With Override										
Standard Synchro										•
Enhanced Synchro With Comfort Drive							•			
Advanced Synchro		•							•	
Seat-Depth Adjustment		•		•			•	•	•	•
Base Colors and Material Options										
Black Nylon	•	•	•	•	•	•		•		•
Brushed Aluminum								•		•
Fog Nylon		•								•
Graphite Nylon							•		•	
Polished Aluminum	•	•		•			•		•	
White Nylon		•					•		•	•

APPENDIX: TASK CHAIR OPTIONS (CONT.)

	AMPLIFY	ANYTIME	FOCUS	FOCUS 2.0	INFLEX	IONIQ	KNACK	LUMIN	MAVIC	MOVI
Base Options										
Lower Cylinder										
Higher Cylinder	•		•	•						
Stool Kit	•	•			•		•	•		•
Extended Stool Kit	•	•			•		•	•		•
Frame Finishes										
Bisque										
Black	•	•	•	•	•	•		•	•	•
Fog	•			•					•	•
Graphite										
Silver					•			•		
White				•		•			•	•
Tech Silver										
Arm Styles and Options										
Armless	•	•	•	•	•		•	•		•
Fixed	•		•		•			•		•
Fixed Loop		•				•	•		•	
Height-Adjustable	•		•	•			•			
Height-Adjustable Break-Away										
Height-Adjustable With Pivot										
Multi-Adjustable (Height/Width)	•		•	•			•			
Multi-Adjustable (Height/Width) Articulating										
Multi-Adjustable (Height/Width) With Pivot										
Fully Adjustable (6-Way)			•							
Fully Adjustable (8-Way)				•						
Fully Multi-Adjustable (10-Way)			•							

APPENDIX: TASK CHAIR OPTIONS (CONT.)

	NON-STOP	NOVO	ONCALL	REALIGN	RELAY	RIO	TORSA	TR2	VECTRA	WIT
Base Options										
Lower Cylinder		•							•	•
Higher Cylinder		•		•			•	•	•	•
Stool Kit	•	•				•		•	•	•
Extended Stool Kit	•	•				•		•	•	•
Frame Finishes										
Bisque		•								
Black		•	•	•	•	•		•		•
Fog		•							•	•
Graphite							•		•	
Silver						•				
White		•					•		•	•
Tech Silver									•	
Arm Styles and Options										
Armless	•	•	•	•	•	•	•	•	•	•
Fixed		•	•		•	•	•	•		•
Fixed Loop	•			•				•		
Height-Adjustable	•	•		•				•	•	•
Height-Adjustable Break-Away	•									
Height-Adjustable With Pivot				•				•		
Multi-Adjustable (Height/Width)	•	•		•			•	•		•
Multi-Adjustable (Height/Width) Articulating	•									
Multi-Adjustable (Height/Width) With Pivot				•				•		
Fully Adjustable (6-Way)										
Fully Adjustable (8-Way)									•	
Fully Multi-Adjustable (10-Way)										

APPENDIX: TASK STOOL OPTIONS

	ANYTIME	AMPLIFY	FOCUS	INFLEX	IONIQ	KNACK	LUMIN	MOVI
Back Size, Styles and Options								
Midback		•	•			•		
Highback		•	•					
Mesh Back		•	•					•
Plastic Back	•			•	•		•	
Thintex Back								
Upholstered Back	•	•	•	•		•	•	
Adjustable Lumbar Support	•		•					
Ballistic Nylon						•		
Seat Styles and Options								
Plastic Seat	•			•			•	
Upholstered Seat	•	•	•	•	•	•	•	•
1" Additional Foam								
Heavy Duty Series								
Arm Styles and Options								
Armless	•	•	•	•		•	•	•
Fixed		•	•	•			•	•
Loop	•				•	•		
Height-Adjustable		•	•			•		
Height-Adjustable Break-Away								
Height-Adjustable With Pivot								
Multi-Adjustable (Height/Width)		•	•			•		
Multi-Adjustable (Height/Width) Articulating								
Multi-Adjustable (Height/Width) With Pivot								
Fully Adjustable (6-Way)			•					
Fully Adjustable (10-Way)			•					
Mechanisms and Controls								
Basic (Swivel Only)	•		•	•		•	•	•
Posture Back								
Swivel Tilt	•				•			
Base Colors and Material Options								
Black Nylon	•	•	•	•	•	•	•	•
Fog Nylon		•					•	•
White Nylon					•			•
Brushed Aluminum								
Polished Aluminum		•	•		•	•		
Stool Kit	•	•	•	•		•	•	•
Extended Stool Kit	•	•	•	•		•	•	•

APPENDIX: TASK STOOL OPTIONS (CONT.)

	NON-STOP	NOVO	ONCALL	REALIGN	RELAY	RIO	TR2	WIT
Back Size, Styles and Options								
Midback	•	•		•			•	•
Highback								
Mesh Back		•						•
Plastic Back			•		•	•	•	
Thintex Back								•
Upholstered Back	•		•	•	•	•	•	
Adjustable Lumbar Support		•						•
Ballistic Nylon	•			•				
Seat Styles and Options								
Plastic Seat			•		•	•		
Upholstered Seat	•	•	•	•	•	•	•	•
1" Additional Foam							•	
Heavy Duty Series	•	•					•	
Arm Styles and Options								
Armless	•	•	•	•	•	•	•	•
Fixed		•	•		•	•	•	•
Fixed Loop	•			•			•	
Height-Adjustable	•	•		•			•	•
Height-Adjustable Break-Away								
Height-Adjustable With Pivot	•			•			•	
Multi-Adjustable (Height/Width)	•	•		•			•	•
Multi-Adjustable (Height/Width) Articulating	•							
Multi-Adjustable (Height/Width) With Pivot				•			•	
Fully Adjustable (6-Way)								
Fully Adjustable (10-Way)								
Mechanisms and Controls								
Basic (Swivel Only)	•	•	•	•	•	•	•	•
Posture Back							•	
Swivel Tilt			•		•			
Base Colors and Material Options								
Black Nylon	•	•	•	•	•	•		•
Fog Nylon		•				•		•
White Nylon		•						•
Brushed Aluminum							•	•
Polished Aluminum	•			•				
Stool Kit	•	•	•	•	•	•	•	•
Extended Stool Kit	•	•	•	•	•	•	•	•

APPENDIX: MULTIPURPOSE CHAIR OPTIONS

	ACHIEVE	BAJA	ANYTIME	FOCUS SIDE	FREELANCE	FREELANCE BARIATRIC	INFLEX	IONIQ	LUMIN
Back Styles and Options									
Mesh Back				•					
Plastic Back	•	•	•		•		•	•	•
Upholstered Back	•	•	•	•	•	•	•		•
Thintex Back									
Ballistic Nylon					•	•			
Wood Back				•					
Seat Styles and Options									
Plastic Seat		•	•		•		•		•
Upholstered Seat	•	•	•	•	•	•	•	•	•
1" Additional Foam	•								
Arm Styles and Options									
Armless	•	•	•	•	•		•		•
Fixed		•					•		•
Fixed Loop	•		•	•	•	•		•	
Tablet Arm				•			•		•
Oversized Tablet Arm				•			•		
Frame Finishes									
Black	•	•	•	•	•	•	•		•
Bisque					•	•			
Chrome		•						•	•
Fog									
Silver	•	•	•	•	•	•	•		•
White		•							
Frame Options									
4-Leg	•	•	•	•	•	•	•	•	•
4-Star								•	
Nester									
Wire Rod/Sled		•			•				•
Glide Options									
Bell									
Clear		•							•
Clear With Felt		•							•
Floor Saver		•	•	•	•	•	•		•
Performance Multi-Surface		•	•	•	•	•	•		•
Standard Multi-Surface	•	•	•	•	•		•	•	•
Steel (Carpet Only)		•	•	•	•	•	•		•
Other Options									
Book Rack					•				
Ganging Bracket	•	•	•	•	•		•		•
Stacking Cart	•	•	•	•	•		•		•

APPENDIX: MULTIPURPOSE CHAIR OPTIONS

	MIKA	MOVI NESTER	ONCALL	QWIZ	RELAY	RELAY NESTER	RIO	ROWDY	WIT SIDE
Back Styles and Options									
Mesh Back		•		•					•
Plastic Back	•		•	•	•	•	•	•	
Upholstered Back			•	•	•	•	•	•	
Thintex Back									•
Ballistic Nylon									
Wood Back									
Seat Styles and Options									
Plastic Seat	•		•	•	•	•	•	•	•
Upholstered Seat	•	•	•	•	•	•	•	•	•
1" Additional Foam									
Arm Styles and Options									
Armless	•	•	•	•	•	•	•	•	•
Fixed			•	•	•	•	•	•	
Fixed Loop		•							•
Tablet Arm							•		
Oversized Tablet Arm									
Frame Finishes									
Black	•	•	•	•	•	•	•	•	•
Bisque									
Chrome			•				•	•	
Fog	•	•		•					
Silver		•			•	•	•		•
White	•	•		•					
Frame Options									
4-Leg	•				•		•		•
4-Star					•		•		•
Nester		•		•		•			
Wire Rod/Sled	•		•				•	•	
Glide Options									
Bell		•							
Clear	•		•	•			•	•	
Clear With Felt	•		•				•	•	
Floor Saver						•	•		•
Performance Multi-Surface							•		•
Standard Multi-Surface	•			•	•	•	•		•
Steel (Carpet Only)						•	•		•
Other Options									
Book Rack									
Ganging Bracket			•		•	•	•	•	•
Stacking Cart	•		•		•		•	•	•

APPENDIX: MULTIPURPOSE STOOL OPTIONS

	ANYTIME	BAJA	FOCUS SIDE	FREELANCE	INFLEX	LUMIN	MIKA	ONCALL	RIO
Back Styles and Options									
Mesh Back			•						
Plastic Back	•	•		•	•	•	•	•	•
Upholstered Back	•	•	•	•	•	•		•	•
Wood Back			•						
Ballistic Nylon				•					
Seat Styles and Options									
Plastic Seat	•	•		•	•	•	•	•	•
Upholstered Seat	•	•	•	•	•	•	•	•	•
1" Additional Foam				•					
Arm Style Options									
Armless	•	•	•	•	•	•	•	•	•
Fixed					•	•		•	•
Loop	•		•	•					
Frame Finish Options									
Black	•	•	•	•	•	•	•	•	•
Silver	•		•	•	•	•			•
Chrome		•					•	•	•
Bisque					•				
Slate					•				
Frame Options									
4-Leg	•		•	•	•	•			•
Wire Rod/Sled		•					•	•	
Counter Stool			•	•	•	•			•
Bar Stool	•	•	•	•	•	•	•	•	•
Glide Options									
Clear		•					•	•	
Clear With Felt		•					•	•	
Floor Saver	•		•	•	•	•			•
Performance Multi-Surface	•		•	•	•	•			•
Standard Multi-Surface	•		•	•	•	•			•
Steel (Carpet Only)	•		•	•	•	•			•

APPENDIX: HEAVY DUTY (350 LB) OPTIONS

	FOCUS TASK CHAIR	GLOVE ACTIVE TASK CHAIR	KNACK TASK CHAIR	NON-STOP TASK STOOL	REALIGN TASK CHAIR	TR2 TASK CHAIR	TR2 TASK STOOL
Back Size, Style and Options							
Midback	•	•	•	•	•	•	•
Highback	•	•			•	•	
Upholstered Back	•	•	•	•	•	•	•
Mesh Back	•						
Plastic Back						•	•
Adjustable Lumbar Support	•						
Ballistic Nylon		•	•	•	•	•	•
Seat Options							
Seat-Depth Adjustment	•	•	•		•	•	
1" Additional Foam						•	•
Arm Style Options							
Armless	•	•	•	•	•	•	•
Fixed						•	•
Fixed Loop				•	•	•	•
Fully Adjustable (6-Way)	•						
Fully Multi-Adjustable (10-Way)	•						
Height-Adjustable	•	•	•	•	•	•	•
Height-Adjustable With Pivot		•			•	•	•
Height-/Width-Adjustable	•	•	•	•	•	•	•
Height-/Width-Adjustable Articulating				•			
Height-/Width-Adjustable Break-Away				•			
Height-/Width-Adjustable With Pivot		•			•	•	•
Mechanisms and Controls							
Basic (Swivel Only)				•			•
Enhanced Synchro		•	•		•	•	
Multi-Function		•	•		•	•	
Swivel Tilt							
Seat-Depth Adjustment	•	•	•		•	•	
Base Colors and Options							
Black Nylon	•	•	•	•	•	•	•
Polished Aluminum	•			•			
Brushed Aluminum		•	•			•	
Caster Options							
Heavy Duty Carpet Casters	•	•	•	•	•	•	•
Heavy Duty Hard Floor and Carpet Casters	•	•	•	•	•	•	•
Sport Carpet Casters	•						

APPENDIX: LARGE AND TALL OPTION AND EXTRA LARGE OPTIONS

	AMPLIFY TASK CHAIR	FOCUS TASK CHAIR	NOVO TASK CHAIR
Back Size, Style and Options			
Highback (Black Frame Only)	•	•	•
Mesh Back	•	•	•
Upholstered Back	•	•	
Adjustable Lumbar Support	•	•	•
Arm Options			
Armless	•	•	•
Height-Adjustable	•	•	•
Height-/Width-Adjustable	•	•	•
Mechanism Options			
Enhanced Synchro	•	•	•
Seat-Depth Adjustment	•	•	•
Base Colors and Options			
Black Nylon	•	•	•
Polished Aluminum	•	•	•
Higher Cylinder	•	•	•
Caster Options			
Heavy Duty Carpet Casters	•	•	•
Heavy Duty Hard Floor and Carpet Casters	•	•	•

EXTRA LARGE 500 LB CAPACITY: NON-STOP HEAVY DUTY TASK CHAIR

Back Size, Style and Options	
Highback	•
Upholstered Back	•
Ballistic Nylon	•
Base Colors and Options	
Polished Aluminum	•
Black Aluminum	•
Arm Options	
Armless	•
Fixed Loop	•
Mechanism Options	
Dual Torsion	•
Caster Options	
Heavy Duty Carpet Casters	•
Heavy Duty Hard Floor and Carpet Casters	•

APPENDIX: EXTRA LARGE AND BARIATRIC SIDE OPTIONS

OPTIONS	FREELANCE MULTIPURPOSE HEAVY DUTY (350 LB CAPACITY)	
Back Size, Style and Options		
Upholstered Back		•
Ballistic Nylon		•
Seat Options		
Upholstered Seat		•
1" Additional Foam		•
Frame Finish Options		
Black		•
Silver		•
Bisque		•
Frame Options		
4-Leg		•
Glide Options		
Floor Saver		•
Performance Multi-Surface		•
Steel (Carpet Only)		•

	500 LB CAPACITY: FREELANCE BARIATRIC (30")	1,000 LB CAPACITY: FREELANCE BARIATRIC (42")
Back Size Options		
Upholstered Back	•	•
Ballistic Nylon	•	•
Seat Style		
Upholstered Seat	•	•
Frame Finish Options		
Black	•	•
Silver	•	•
Bisque	•	•
Glide Options		
Floor Saver	•	•
Performance Multi-Surface	•	•
Steel Glide	•	•